



Test Report issued under the responsibility of:



TEST REPORT IEC 62368-1 Audio/video, information and communication technology equipment Part 1: Safety requirements	
Report Number.	SHES241202393701
Date of issue	2024-12-23
Total number of pages	57 Pages
Name of Testing Laboratory preparing the Report	SGS-CSTC Standards Technical Services (Shanghai) Co., Ltd.
Applicant's name	Hangzhou Hikvision Digital Technology Co., Ltd.
Address	No. 555 Qianmo Road, Binjiang District, Hangzhou 310052, China
Test specification:	
Standard	IEC 62368-1:2018
Test procedure	CB Scheme
Non-standard test method	N/A
TRF template used	IECEE OD-2020-F1:2021, Ed.1.4
Test Report Form No.	IEC62368_1E
Test Report Form(s) Originator	UL(US)
Master TRF	Dated 2022-04-14
Copyright © 2022 IEC System of Conformity Assessment Schemes for Electrotechnical Equipment and Components (IECEE System). All rights reserved. This publication may be reproduced in whole or in part for non-commercial purposes as long as the IECEE is acknowledged as copyright owner and source of the material. IECEE takes no responsibility for and will not assume liability for damages resulting from the reader's interpretation of the reproduced material due to its placement and context. If this Test Report Form is used by non-IECEE members, the IECEE/IEC logo and the reference to the CB Scheme procedure shall be removed.	
This report is not valid as a CB Test Report unless signed by an approved CB Testing Laboratory and appended to a CB Test Certificate issued by an NCB in accordance with IECEE 02.	
General disclaimer:	
The test results presented in this report relate only to the object tested. This report shall not be reproduced, except in full, without the written approval of the Issuing CB Testing Laboratory. The authenticity of this Test Report and its contents can be verified by contacting the NCB, responsible for this Test Report.	

Test item description	Network storage system or IP SAN/NAS	
Trade Mark(s)	HIKVISION	
Manufacturer	Same as applicant	
Model/Type reference	See page 8	
Ratings	100 V a.c.-240 V a.c., 60/50 Hz, 7-3,5 A x 2; Class I	
Responsible Testing Laboratory (as applicable), testing procedure and testing location(s):		
<input checked="" type="checkbox"/>	CB Testing Laboratory:	SGS-CSTC Standards Technical Services (Shanghai) Co., Ltd.
Testing location/ address		588 West Jindu Road, Xinqiao, Songjiang, 201612 Shanghai, China.
Tested by (name, function, signature)		Emilien Li <i>Emilien Li</i> Project Engineer
Approved by (name, function, signature) ..		Leo Wang <i>Leo Wang</i> Reviewer
<input type="checkbox"/>	Testing procedure: CTF Stage 1:	
Testing location/ address		
Tested by (name, function, signature)		
Approved by (name, function, signature) ..		
<input type="checkbox"/>	Testing procedure: CTF Stage 2:	
Testing location/ address		
Tested by (name, function, signature)		
Witnessed by (name, function, signature) . :		
Approved by (name, function, signature) .. :		
<input type="checkbox"/>	Testing procedure: CTF Stage 3:	
<input type="checkbox"/>	Testing procedure: CTF Stage 4:	
Testing location/ address		
Tested by (name, function, signature)		
Witnessed by (name, function, signature) . :		
Approved by (name, function, signature) .. :		
Supervised by (name, function, signature) :		

List of Attachments (including a total number of pages in each attachment):

Attachment 1 – 32 pages of Photos documents;

Attachment 2 – 23 pages of European group differences and national differences;

Attachment 3 – 30 pages of Deviations of Australian and New Zealand;

Attachment 4 – 2 pages of Safety information.

Summary of test

The sample(s) tested complies with the requirements of IEC 62368-1: 2018, EN IEC 62368-1:2020+ A11:2020 and AS/NZS 62368.1:2022.

Unless otherwise specified, the EUT with model DS-A81024S was selected as representative model for full testing.

Max normal load condition

All connectors loaded, and working continuously, and loading 4,5W per USB 3.0 port. All optical transceiver ports transmitted data under maximum load of power board.

All test data are based on UL CB test report (Report Number: E307937-A6226-CB-1, dated on 2022-08-21 and E307937-A6226-CB-1 Amendment 1, dated on 2024-03-14) with the following test:

1. Update the test standard to IEC 62368-1: 2018, EN IEC 62368-1:2020+ A11:2020 and AS/NZS 62368.1:2022.
2. Add evaluation of deviations of Australian and New Zealand.
3. Update the series model designation, please see model table on page 8 for details.
4. Add a new series model DS-A*****/* which is identical with original except model name, please see model table on page 8 for details.
5. Add an alternative product name IP SAN/NAS.
6. Update the marking plate, please see page 5 for details.

After evaluation, the following tests were considered to perform for the differences.

1. Supplementary test for clause 5.7.4 Prospective touch voltage, touch current and protective conductor current-Unearthed accessible parts.
2. Supplementary test for clause 5.4.9 Electric strength tests for L/N to plastic enclosure.
3. Retest clause 8.8 Handles strength
4. Retest clause B.2.5 Input test for 100VAC/60Hz.

Heating test:

T_{ma} = 40°C (declared by manufacturer)

K-type thermocouple used for temperature measurement.

Tests performed (name of test and test clause):

- 4. General requirements
- 5. Electrically-caused injury

Testing location:

SGS-CSTC Standards Technical Services
(Shanghai) Co., Ltd.

588 West Jindu Road, Xinqiao, Songjiang, 201612

<input checked="" type="checkbox"/> 6. Electrically-caused fire <input checked="" type="checkbox"/> 7. Injury caused by hazardous substances <input checked="" type="checkbox"/> 8. Mechanically-caused injury <input checked="" type="checkbox"/> 9. Thermal burn injury <input checked="" type="checkbox"/> 10. Radiation <input checked="" type="checkbox"/> Annex B. Normal operating condition tests, abnormal operating condition tests and single fault condition tests <input checked="" type="checkbox"/> Annex F.3.9. Performance of Marking test <input checked="" type="checkbox"/> Annex M Equipment containing batteries and their protection circuits <input checked="" type="checkbox"/> Annex Q. Limited Power Source <input checked="" type="checkbox"/> Annex T. Mechanical strength tests <input checked="" type="checkbox"/> Annex V. Determination of accessible parts	Shanghai, China
<p>Summary of compliance with National Differences (List of countries addressed):</p> <ol style="list-style-type: none"> 1. EU Group Differences (EN IEC 62368-1:2020+A11:2020) 2. EU Special National Conditions, EU A-deviations: DE, DK, FI, FR, GB, IE, NO, SE 3. Australia and New Zealand Differences (AS/NZS 62368.1:2022) <p>Explanation of used codes: DE=Germany, DK=Denmark, FI=Finland, FR=France, GB= United Kingdom, IE=Ireland, NO=Norway, SE=Sweden</p> <p><input checked="" type="checkbox"/> The products fulfil the requirements.</p>	
<p>Use of uncertainty of measurement for decisions on conformity (decision rule) :</p> <p><input checked="" type="checkbox"/> No decision rule is specified by the IEC standard, when comparing the measurement result with the applicable limit according to the specification in that standard. The decisions on conformity are made without applying the measurement uncertainty ("simple acceptance" decision rule, previously known as "accuracy method").</p> <p><input type="checkbox"/> Other:... (to be specified, for example when required by the standard or client, or if national accreditation requirements apply)</p> <p>Information on uncertainty of measurement: The uncertainties of measurement are calculated by the laboratory based on application of criteria given by OD-5014 for test equipment and application of test methods, decision sheets and operational procedures of IECEE. IEC Guide 115 provides guidance on the application of measurement uncertainty principles and applying the decision rule when reporting test results within IECEE scheme, noting that the reporting of the measurement uncertainty for measurements is not necessary unless required by the test standard or customer. Calculations leading to the reported values are on file with the NCB and testing laboratory that conducted the testing.</p>	

Copy of marking plate:

The artwork below may be only a draft. The use of certification marks on a product must be authorized by the respective National Certification Body that own these marks.

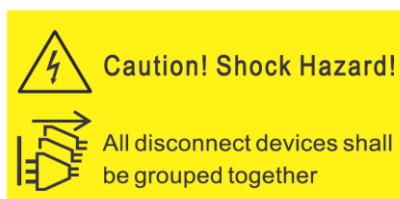
Marking for model DS-A81024S**HIKVISION****IP SAN/NAS****Model: DS-A81024S****SN: AB2345678****I/P: 100-240V~, 60/50 Hz, 7-3.5A x2****Made in China****Manufacturer: Hangzhou Hikvision Digital Technology Co.,Ltd.****Address: No.555 Qianmo Road, Binjiang District, Hangzhou 310052, China****Remark:**

- 1) The Height of CE logo shall not be less than 5 mm; Height of WEEE logo shall not be less than 7 mm.
- 2) As declared by the applicant, the importer (and manufacturer, if it is different)'s name, registered trade name or registered trade mark and the postal address will be marked on the products before being placed on the market. The contact details shall be in a language easily understood by end-users and market surveillance authorities.
- 3) The marking plates for other models are of the same pattern except for model name and product name.

Test item particulars:			
Product group	<input checked="" type="checkbox"/> end product	<input type="checkbox"/> built-in component	
Classification of use by	<input checked="" type="checkbox"/> Ordinary person	<input type="checkbox"/> Children likely present	
	<input checked="" type="checkbox"/> Instructed person		
	<input checked="" type="checkbox"/> Skilled person		
Supply connection	<input checked="" type="checkbox"/> AC mains	<input type="checkbox"/> DC mains	
	<input type="checkbox"/> not mains connected:		
	<input type="checkbox"/> ES1	<input type="checkbox"/> ES2	<input type="checkbox"/> ES3
Supply tolerance	<input checked="" type="checkbox"/> +10%/-10%		
	<input type="checkbox"/> +20%/-15%		
	<input type="checkbox"/> + %/ - %		
	<input type="checkbox"/> None		
Supply connection – type	<input checked="" type="checkbox"/> pluggable equipment type A -		
	<input type="checkbox"/> non-detachable supply cord		
	<input checked="" type="checkbox"/> appliance coupler		
	<input type="checkbox"/> direct plug-in		
	<input type="checkbox"/> pluggable equipment type B -		
	<input type="checkbox"/> non-detachable supply cord		
	<input type="checkbox"/> appliance coupler		
	<input type="checkbox"/> permanent connection		
	<input checked="" type="checkbox"/> mating connector (for PSU GW-CRPS550N)		
	<input type="checkbox"/> other:		
Considered current rating of protective device	<input checked="" type="checkbox"/> 20 A		
	Location:	<input checked="" type="checkbox"/> building	<input type="checkbox"/> equipment
	<input type="checkbox"/> N/A		
Equipment mobility	<input type="checkbox"/> movable	<input type="checkbox"/> hand-held	<input type="checkbox"/> transportable
	<input type="checkbox"/> direct plug-in	<input checked="" type="checkbox"/> stationary	<input type="checkbox"/> for building-in
	<input type="checkbox"/> wall/ceiling-mounted	<input type="checkbox"/> SRME/rack-mounted	
	<input type="checkbox"/> other:		
Overvoltage category (OVC)	<input type="checkbox"/> OVC I	<input checked="" type="checkbox"/> OVC II	<input type="checkbox"/> OVC III
	<input type="checkbox"/> OVC IV	<input type="checkbox"/> other:	
Class of equipment	<input checked="" type="checkbox"/> Class I	<input type="checkbox"/> Class II	<input type="checkbox"/> Class III
	<input type="checkbox"/> Not classified		
Special installation location	<input checked="" type="checkbox"/> N/A	<input type="checkbox"/> restricted access area	
	<input type="checkbox"/> outdoor location		
Pollution degree (PD)	<input type="checkbox"/> PD 1	<input checked="" type="checkbox"/> PD 2	<input type="checkbox"/> PD 3
Manufacturer's specified T_{ma}	40 °C	<input type="checkbox"/> Outdoor: minimum	°C
IP protection class	<input checked="" type="checkbox"/> IPX0	<input type="checkbox"/> IP__	
Power systems	<input checked="" type="checkbox"/> TN	<input checked="" type="checkbox"/> TT	<input type="checkbox"/> IT - V _{L-L}
	<input type="checkbox"/> not AC mains		
Altitude during operation (m)	<input type="checkbox"/> 2000 m or less	<input checked="" type="checkbox"/> 5000 m	
Altitude of test laboratory (m)	<input checked="" type="checkbox"/> 2000 m or less	<input type="checkbox"/> m	
Mass of equipment (kg)	44,16 kg (Including hard disk weight)		

Possible test case verdicts:	
- test case does not apply to the test object	
- test object does meet the requirement.....	
- test object does not meet the requirement.....	
Testing:	
Date of receipt of test item	
Date (s) of performance of tests	
General remarks:	
<p>"(See Enclosure #)" refers to additional information appended to the report. "(See appended table)" refers to a table appended to the report.</p> <p>Throughout this report a <input checked="" type="checkbox"/> comma / <input type="checkbox"/> point is used as the decimal separator.</p> <p>This document is issued by the Company subject to its General Conditions of Service printed overleaf, available on request or accessible at http://www.sgs.com/en/Terms-and-Conditions.aspx and, for electronic format documents, subject to Terms and Conditions for Electronic Documents at http://www.sgs.com/en/Terms-and-Conditions/Terms-e-Documents.aspx. Attention is drawn to the limitation of liability, indemnification and jurisdiction issues defined therein. Any holder of this document is advised that information contained hereon reflects the Company's findings at the time of its intervention only and within the limits of Client's instructions, if any. The Company's sole responsibility is to its Client and this document does not exonerate parties to a transaction from exercising all their rights and obligations under the transaction documents. This document cannot be reproduced except in full, without prior written approval of the Company. Any unauthorized alteration, forgery or falsification of the content or appearance of this document is unlawful and offenders may be prosecuted to the fullest extent of the law. Unless otherwise stated the results shown in this test report refer only to the sample(s) tested and such sample(s) are retained for 30 days only.</p>	
Manufacturer's Declaration per sub-clause 4.2.5 of IECEE 02:	
The application for obtaining a CB Test Certificate includes more than one factory location and a declaration from the Manufacturer stating that the sample(s) submitted for evaluation is (are) representative of the products from each factory has been provided	<input checked="" type="checkbox"/> Yes <input type="checkbox"/> Not applicable Factory declaration letter.pdf, dated on 2024-12-06.
When differences exist; they shall be identified in the General product information section.	
Name and address of factory (ies)	1. Hangzhou Hikvision Technology Co., Ltd. No. 700, Dongliu Road, Binjiang District, Hangzhou City, Zhejiang, 310052, China 2. Hangzhou Hikvision Electronics Co., Ltd. No. 299, Qiushi Road, Tonglu Economic Development Zone, Tonglu County, Hangzhou, Zhejiang, 311500, China 3. Chongqing Hikvision technology Co., Ltd. No. 118, Haikang Road, Area C, Jianqiao Industrial Park, Dadukou District, Chongqing, 401325, China

General product information:**Product Description –**

Functions	<p>Unit was supplied by 2 inserted power supply modules. Consist of CPU, HDD (or S.S.D), mainboard and Fan etc.</p> <p>All components were mounted on PWB and housed with metal enclosure. Only limited plastic enclosure near system switch. The cover is secured by lock.</p> <p>The plug-in laser device modules not provided with the product and it will be evaluated in final product system.</p>
Material of enclosure	Metal & plastic
Others	Indoor use only
Model Differences	All the models are identical except for model name, sales area, software version and customer codes which have no impact for safety.

Model / Type Ref		Model remark
DS-A81024S	DS-A8****-****/****	* =0-9 or A-Z or / or - or + or blank, can be optional, * can be denote different sales area, denotes different software version, denotes different customer codes.
DS-AT1000S	DS-A*****	
DS-A*****/****	--	

Additional application considerations – (Considerations used to test a component or sub-assembly) –

OVERVIEW OF ENERGY SOURCES AND SAFEGUARDS				
Clause	Possible Hazard			
5	Electrically-caused injury			
Class and Energy Source (e.g. ES3: Primary circuit)	Body Part (e.g. Ordinary)	Safeguards		
		B	S	R
ES3: Power input and primary circuit	Ordinary, Instructed and Skilled Person	Basic Insulation	Protective Earthing	Double or Reinforced insulation distance
ES1: Other internal circuit	Ordinary, Instructed and Skilled Person	N/A	N/A	N/A
ES1: All accessible parts	Ordinary, Instructed and Skilled Person	N/A	N/A	N/A
6	Electrically-caused fire			
Class and Energy Source (e.g. PS2: 100 Watt circuit)	Material part (e.g. Printed board)	Safeguards		
		B	1 st S	2 nd S
PS3: Power input	Enclosure, materials inside and outside the enclosure	meet clause 6.3	meet clause 6.4.6	N/A
PS3: All internal circuits	Enclosure, materials inside and outside the enclosure	meet clause 6.3	meet clause 6.4.6	N/A
PS2: Output ports	Enclosure, materials inside and outside the enclosure	meet clause 6.3	meet clause 6.4.5	N/A
7	Injury caused by hazardous substances			
Class and Energy Source (e.g. Ozone)	Body Part (e.g., Skilled)	Safeguards		
		B	S	R
RTC Battery	Ordinary, Instructed and Skilled Person	N/A	N/A	Comply with Annex M
8	Mechanically-caused injury			
Class and Energy Source (e.g. MS3: Plastic fan blades)	Body Part (e.g. Ordinary)	Safeguards		
		B	S	R
MS1: Sharp edges and corners	Ordinary, Instructed and Skilled Person	N/A	N/A	N/A
MS3: Equipment mass	Ordinary, Instructed and Skilled Person	N/A	N/A	Comply with clause 8.6
MS3: DC fan	Ordinary, Instructed and Skilled Person	N/A	N/A	Comply with clause 8.5
9	Thermal burn			
Class and Energy Source (e.g. TS1: Keyboard caps)	Body Part (e.g., Ordinary)	Safeguards		
		B	S	R
TS1: The outer enclosure of the equipment	Ordinary, Instructed and Skilled Person	N/A	N/A	N/A

10	Radiation			
Class and Energy Source (e.g. RS1: PMP sound output)	Body Part (e.g., Ordinary)	Safeguards		
		B	S	R
LEDs only as indicator	Ordinary, Instructed and Skilled Person	N/A	N/A	N/A
Supplementary Information: "B" – Basic Safeguard; "S" – Supplementary Safeguard; "R" – Reinforced Safeguard				

ENERGY SOURCE DIAGRAM

Optional. Manufacturers are to provide the energy sources diagram identify declared energy sources and identifying the demarcations are between power sources. Recommend diagram be provided included in power supply and multipart systems.

Insert diagram below. Example diagram designs are; Block diagrams; image(s) with layered data; mechanical drawings

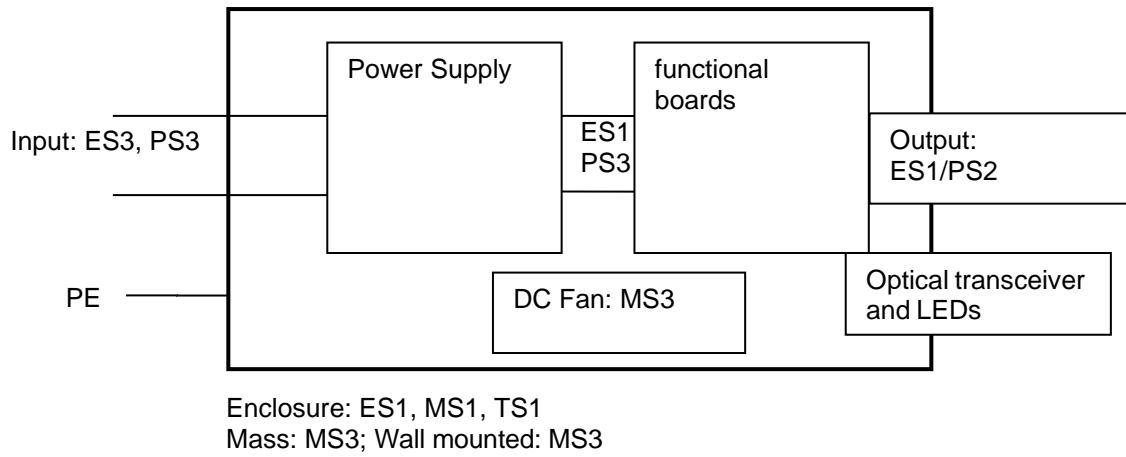

IEC 62368-1			
Clause	Requirement + Test	Result - Remark	Verdict
4	GENERAL REQUIREMENTS		P
4.1.1	Acceptance of materials, components and subassemblies		P
4.1.2	Use of components		P
4.1.3	Equipment design and construction		P
4.1.4	Specified ambient temperature for outdoor use (°C) :		N/A
4.1.5	Constructions and components not specifically covered	No such part	N/A
4.1.8	Liquids and liquid filled components (LFC)		N/A
4.1.15	Markings and instructions	(See Annex F)	P
4.4.3	Safeguard robustness		P
4.4.3.1	General		P
4.4.3.2	Steady force tests	(See Annex T.5)	P
4.4.3.3	Drop tests		N/A
4.4.3.4	Impact tests	(See Annex T.6)	P
4.4.3.5	Internal accessible safeguard tests		N/A
4.4.3.6	Glass impact tests		N/A
4.4.3.7	Glass fixation tests		N/A
	Glass impact test (1J)		N/A
	Push/pull test (10 N)		N/A
4.4.3.8	Thermoplastic material tests		N/A
4.4.3.9	Air comprising a safeguard		P
4.4.3.10	Accessibility, glass, safeguard effectiveness		P
4.4.4	Displacement of a safeguard by an insulating liquid		N/A
4.4.5	Safety interlocks		N/A
4.5	Explosion		P
4.5.1	General	(See Annex M for batteries)	P
4.5.2	No explosion during normal/abnormal operating condition	(See Clause B.2, B.3)	P
	No harm by explosion during single fault conditions	(See Clause B.4)	N/A
4.6	Fixing of conductors		P
	Fix conductors not to defeat a safeguard	Elevated in the approved power supply separately.	P
	Compliance is checked by test :	Elevated in the approved power supply separately.	P

IEC 62368-1			
Clause	Requirement + Test	Result - Remark	Verdict
4.7	Equipment for direct insertion into mains socket-outlets		N/A
4.7.2	Mains plug part complies with relevant standard .. :		N/A
4.7.3	Torque (Nm)		N/A
4.8	Equipment containing coin/button cell batteries		N/A
4.8.1	General	Professional equipment.	N/A
4.8.2	Instructional safeguard		N/A
4.8.3	Battery compartment door/cover construction		N/A
	Open torque test		N/A
4.8.4.2	Stress relief test		N/A
4.8.4.3	Battery replacement test		N/A
4.8.4.4	Drop test		N/A
4.8.4.5	Impact test		N/A
4.8.4.6	Crush test		N/A
4.8.5	Compliance		N/A
	30N force test with test probe		N/A
	20N force test with test hook		N/A
4.9	Likelihood of fire or shock due to entry of conductive object		P
4.10	Component requirements		P
4.10.1	Disconnect Device	(See Annex L)	P
4.10.2	Switches and relays	(See Annex G)	P
5	ELECTRICALLY-CAUSED INJURY		P
5.2	Classification and limits of electrical energy sources		P
5.2.2	ES1, ES2 and ES3 limits		P
5.2.2.2	Steady-state voltage and current limits	(See appended table 5.2)	P
5.2.2.3	Capacitance limits	Considered in power supply test report.	P
5.2.2.4	Single pulse limits		N/A
5.2.2.5	Limits for repetitive pulses		N/A
5.2.2.6	Ringling signals		N/A
5.2.2.7	Audio signals		N/A
5.3	Protection against electrical energy sources		P
5.3.1	General Requirements for accessible parts to ordinary, instructed and skilled persons		P
5.3.1 a)	Accessible ES1/ES2 derived from ES2/ES3 circuits		N/A

IEC 62368-1			
Clause	Requirement + Test	Result - Remark	Verdict
5.3.1 b)	Skilled persons not unintentional contact ES3 bare conductors		N/A
5.3.2.1	Accessibility to electrical energy sources and safeguards		P
	Accessibility to outdoor equipment bare parts		N/A
5.3.2.2	Contact requirements		P
	Test with test probe from Annex V	Figure V.2	-
5.3.2.2 a)	Air gap – electric strength test potential (V)		N/A
5.3.2.2 b)	Air gap – distance (mm)	More than 2mm.	P
5.3.2.3	Compliance		P
5.3.2.4	Terminals for connecting stripped wire		N/A
5.4	Insulation materials and requirements		P
5.4.1.2	Properties of insulating material		P
5.4.1.3	Material is non-hygroscopic		P
5.4.1.4	Maximum operating temperature for insulating materials	(See appended table 5.4.1.4)	P
5.4.1.5	Pollution degrees	2	P
5.4.1.5.2	Test for pollution degree 1 environment and for an insulating compound		N/A
5.4.1.5.3	Thermal cycling test		N/A
5.4.1.6	Insulation in transformers with varying dimensions		N/A
5.4.1.7	Insulation in circuits generating starting pulses		N/A
5.4.1.8	Determination of working voltage	Evaluated in internal power supply test report.	P
5.4.1.9	Insulating surfaces		P
5.4.1.10	Thermoplastic parts on which conductive metallic parts are directly mounted		P
5.4.1.10.2	Vicat test.....		N/A
5.4.1.10.3	Ball pressure test	Evaluated in internal power supply test report.	P
5.4.2	Clearances	Evaluated in internal power supply report, all critical clearance distances are covered in power supply evaluation.	P
5.4.2.1	General requirements		P
	Clearances in circuits connected to AC Mains, Alternative method		N/A

IEC 62368-1			
Clause	Requirement + Test	Result - Remark	Verdict
5.4.2.2	Procedure 1 for determining clearance	Evaluated in internal power supply test report.	P
	Temporary overvoltage	2000	—
5.4.2.3	Procedure 2 for determining clearance		P
5.4.2.3.2.2	a.c. mains transient voltage	2500	—
5.4.2.3.2.3	d.c. mains transient voltage		—
5.4.2.3.2.4	External circuit transient voltage.....		—
5.4.2.3.2.5	Transient voltage determined by measurement		—
5.4.2.4	Determining the adequacy of a clearance using an electric strength test		N/A
5.4.2.5	Multiplication factors for clearances and test voltages	1,48	P
5.4.2.6	Clearance measurement	(See appended table 5.4.2)	P
5.4.3	Creepage distances	Evaluated in internal power supply report, creepages in primary circuits covered in power supply evaluation.	P
5.4.3.1	General		P
5.4.3.3	Material group	IIIb	—
5.4.3.4	Creepage distances measurement	(See appended table 5.4.3)	P
5.4.4	Solid insulation	All critical distances through insulation are covered in power supply evaluation.	P
5.4.4.1	General requirements		P
5.4.4.2	Minimum distance through insulation	All critical distances through insulation are covered in power supply evaluation.	P
5.4.4.3	Insulating compound forming solid insulation		N/A
5.4.4.4	Solid insulation in semiconductor devices		N/A
5.4.4.5	Insulating compound forming cemented joints		N/A
5.4.4.6	Thin sheet material	Evaluated in internal power supply test report.	P
5.4.4.6.1	General requirements	Evaluated in internal power supply test report.	P
5.4.4.6.2	Separable thin sheet material	Evaluated in internal power supply test report.	P
	Number of layers (pcs)	Evaluated in internal power supply test report.	P
5.4.4.6.3	Non-separable thin sheet material		N/A

IEC 62368-1			
Clause	Requirement + Test	Result - Remark	Verdict
	Number of layers (pcs)		N/A
5.4.4.6.4	Standard test procedure for non-separable thin sheet material	(See appended table 5.4.9)	N/A
5.4.4.6.5	Mandrel test		N/A
5.4.4.7	Solid insulation in wound components		N/A
5.4.4.9	Solid insulation at frequencies >30 kHz, E_P , K_R , d , V_{PW} (V)		N/A
	Alternative by electric strength test, tested voltage (V), K_R		N/A
5.4.5	Antenna terminal insulation		N/A
5.4.5.1	General		N/A
5.4.5.2	Voltage surge test		N/A
5.4.5.3	Insulation resistance (M Ω)		N/A
	Electric strength test		N/A
5.4.6	Insulation of internal wire as part of supplementary safeguard		N/A
5.4.7	Tests for semiconductor components and for cemented joints		N/A
5.4.8	Humidity conditioning		P
	Relative humidity (%), temperature ($^{\circ}$ C), duration (h)	Evaluated in internal power supply test report.	—
5.4.9	Electric strength test	(See appended table 5.4.9)	P
5.4.9.1	Test procedure for type test of solid insulation	(See appended table 5.4.9)	P
5.4.9.2	Test procedure for routine test		N/A
5.4.10	Safeguards against transient voltages from external circuits		N/A
5.4.10.1	Parts and circuits separated from external circuits		N/A
5.4.10.2	Test methods		N/A
5.4.10.2.1	General		N/A
5.4.10.2.2	Impulse test		N/A
5.4.10.2.3	Steady-state test		N/A
5.4.10.3	Verification for insulation breakdown for impulse test		N/A
5.4.11	Separation between external circuits and earth		N/A
5.4.11.1	Exceptions to separation between external circuits and earth		N/A
5.4.11.2	Requirements		N/A

IEC 62368-1			
Clause	Requirement + Test	Result - Remark	Verdict
	SPDs bridge separation between external circuit and earth		N/A
	Rated operating voltage U_{op} (V)..... :		—
	Nominal voltage U_{peak} (V)..... :		—
	Max increase due to variation ΔU_{sp} :		—
	Max increase due to ageing ΔU_{sa} :		—
5.4.11.3	Test method and compliance..... :		N/A
5.4.12	Insulating liquid		N/A
5.4.12.1	General requirements		N/A
5.4.12.2	Electric strength of an insulating liquid..... :		N/A
5.4.12.3	Compatibility of an insulating liquid..... :		N/A
5.4.12.4	Container for insulating liquid..... :		N/A
5.5	Components as safeguards		P
5.5.1	General		P
5.5.2	Capacitors and RC units	Evaluated in internal power supply test report.	P
5.5.2.1	General requirement		P
5.5.2.2	Safeguards against capacitor discharge after disconnection of a connector..... :	Evaluated as part of certified switching power supply module, and no additional circuit between line and neutral.	P
5.5.3	Transformers	Evaluated in internal power supply test report.	P
5.5.4	Optocouplers	Evaluated in internal power supply test report.	P
5.5.5	Relays	Evaluated in internal power supply test report.	P
5.5.6	Resistors		N/A
5.5.7	SPDs		N/A
5.5.8	Insulation between the mains and an external circuit consisting of a coaxial cable..... :		N/A
5.5.9	Safeguards for socket-outlets in outdoor equipment		N/A
	RCD rated residual operating current (mA)..... :		—
5.6	Protective conductor		P
5.6.2	Requirement for protective conductors	Accessible parts are earthed. Protective earthing provided as one level of protection against electric shock.	P

IEC 62368-1			
Clause	Requirement + Test	Result - Remark	Verdict
5.6.2.1	General requirements		P
5.6.2.2	Colour of insulation	Evaluated as part of certified switching power supply module.	P
5.6.3	Requirement for protective earthing conductors		P
	Protective earthing conductor size (mm ²) :	Evaluated as part of certified switching power supply module.	—
	Protective earthing conductor serving as a reinforced safeguard		N/A
	Protective earthing conductor serving as a double safeguard		N/A
5.6.4	Requirements for protective bonding conductors		P
5.6.4.1	Protective bonding conductors		P
	Protective bonding conductor size (mm ²). :	Evaluated as part of certified switching power supply module.	—
5.6.4.2	Protective current rating (A)..... :	20A	P
5.6.5	Terminals for protective conductors		P
5.6.5.1	Terminal size for connecting protective earthing conductors (mm)..... :	The earthing terminal in the appliance inlet is regarded as the main protective earthing terminal.	P
	Terminal size for connecting protective bonding conductors (mm) :	Evaluated as part of certified switching power supply module.	P
5.6.5.2	Corrosion		P
5.6.6	Resistance of the protective bonding system	All the conductors meet the required conductor sizes. All the Terminals meet the required Terminal sizes.	P
5.6.6.1	Requirements		P
5.6.6.2	Test Method..... :	(See appended table 5.6.6)	P
5.6.6.3	Resistance (Ω) or voltage drop..... :	(See appended table 5.6.6)	P
5.6.7	Reliable connection of a protective earthing conductor		N/A
5.6.8	Functional earthing		N/A
	Conductor size (mm ²)..... :		N/A
	Class II with functional earthing marking :		N/A
	Appliance inlet cl & cr (mm)..... :		N/A

IEC 62368-1			
Clause	Requirement + Test	Result - Remark	Verdict
5.7	Prospective touch voltage, touch current and protective conductor current		P
5.7.2	Measuring devices and networks		P
5.7.2.1	Measurement of touch current		P
5.7.2.2	Measurement of voltage		P
5.7.3	Equipment set-up, supply connections and earth connections		P
5.7.4	Unearthed accessible parts	(See appended table 5.7.4)	P
5.7.5	Earthed accessible conductive parts	(See appended table 5.7.5)	P
5.7.6	Requirements when touch current exceeds ES2 limits		N/A
	Protective conductor current (mA)		N/A
	Instructional Safeguard		N/A
5.7.7	Prospective touch voltage and touch current associated with external circuits		N/A
5.7.7.1	Touch current from coaxial cables		N/A
5.7.7.2	Prospective touch voltage and touch current associated with paired conductor cables		N/A
5.7.8	Summation of touch currents from external circuits		N/A
	a) Equipment connected to earthed external circuits, current (mA)		N/A
	b) Equipment connected to unearthed external circuits, current (mA)		N/A
5.8	Backfeed safeguard in battery backed up supplies		N/A
	Mains terminal ES		N/A
	Air gap (mm)		N/A

6	ELECTRICALLY- CAUSED FIRE		P
6.2	Classification of PS and PIS		P
6.2.2	Power source circuit classifications	(See appended table 6.2.2)	P
6.2.3	Classification of potential ignition sources		P
6.2.3.1	Arcing PIS	(See appended table 6.2.3.1)	P
6.2.3.2	Resistive PIS	(See appended table 6.2.3.2)	P
6.3	Safeguards against fire under normal operating and abnormal operating conditions		P
6.3.1	No ignition and attainable temperature value less than 90 % defined by ISO 871 or less than 300 °C for unknown materials	(See appended table 5.4.1.4, 9.3, B.1.5, B.2.6)	P
	Combustible materials outside fire enclosure	Min. HB	P

IEC 62368-1			
Clause	Requirement + Test	Result - Remark	Verdict
6.4	Safeguards against fire under single fault conditions		P
6.4.1	Safeguard method	Control fire spread.	P
6.4.2	Reduction of the likelihood of ignition under single fault conditions in PS1 circuits		N/A
6.4.3	Reduction of the likelihood of ignition under single fault conditions in PS2 and PS3 circuits		N/A
6.4.3.1	Supplementary safeguards		N/A
6.4.3.2	Single Fault Conditions :		N/A
	Special conditions for temperature limited by fuse		N/A
6.4.4	Control of fire spread in PS1 circuits		N/A
6.4.5	Control of fire spread in PS2 circuits		P
6.4.5.2	Supplementary safeguards		P
6.4.6	Control of fire spread in PS3 circuits		P
6.4.7	Separation of combustible materials from a PIS		N/A
6.4.7.2	Separation by distance		N/A
6.4.7.3	Separation by a fire barrier		N/A
6.4.8	Fire enclosures and fire barriers		P
6.4.8.2	Fire enclosure and fire barrier material properties		P
6.4.8.2.1	Requirements for a fire barrier		N/A
6.4.8.2.2	Requirements for a fire enclosure	The fire enclosure material is metal.	P
6.4.8.3	Constructional requirements for a fire enclosure and a fire barrier		P
6.4.8.3.1	Fire enclosure and fire barrier openings		P
6.4.8.3.2	Fire barrier dimensions		N/A
6.4.8.3.3	Top openings and properties		P
	Openings dimensions (mm)..... :	Unit top side and front panel openings are not exceed 5mm in any dimension. No openings fall within the area indicated in Figure 41.	P
6.4.8.3.4	Bottom openings and properties		P
	Openings dimensions (mm)..... :	No openings.	P
	Flammability tests for the bottom of a fire enclosure		N/A
	Instructional Safeguard..... :		N/A
6.4.8.3.5	Side openings and properties		P

IEC 62368-1			
Clause	Requirement + Test	Result - Remark	Verdict
	Openings dimensions (mm)..... :	Unit right and left side openings not exceed 5mm in any dimension; Unit rear panel openings either not exceed 5mm in any dimension, or not within fire cone top area of PIS of PS3 circuits. No openings fall within the area indicated in Figure 44.	P
6.4.8.3.6	Integrity of a fire enclosure, condition met: a), b) or c)..... :		N/A
6.4.8.4	Separation of a PIS from a fire enclosure and a fire barrier distance (mm) or flammability rating :	Enclosure is metal material only.	P
6.4.9	Flammability of insulating liquid..... :		N/A
6.5	Internal and external wiring		P
6.5.1	General requirements	1) VW-1 wires used, Which considered to equivalent to IEC/TS 60695-11-21 2) Acceptance of components and component requirements from IEC 60065 and IEC 60950-1.	P
6.5.2	Requirements for interconnection to building wiring :		N/A
6.5.3	Internal wiring size (mm ²) for socket-outlets..... :		N/A
6.6	Safeguards against fire due to the connection to additional equipment		P
7	INJURY CAUSED BY HAZARDOUS SUBSTANCES		P
7.2	Reduction of exposure to hazardous substances		P
7.3	Ozone exposure		N/A
7.4	Use of personal safeguards or personal protective equipment (PPE)		N/A
	Personal safeguards and instructions :		—
7.5	Use of instructional safeguards and instructions		N/A
	Instructional safeguard (ISO 7010)..... :		—
7.6	Batteries and their protection circuits		P
8	MECHANICALLY-CAUSED INJURY		P
8.2	Mechanical energy source classifications		P
8.3	Safeguards against mechanical energy sources		P

IEC 62368-1			
Clause	Requirement + Test	Result - Remark	Verdict
8.4	Safeguards against parts with sharp edges and corners		N/A
8.4.1	Safeguards	No sharp edges or corners.	N/A
	Instructional Safeguard.....:		N/A
8.4.2	Sharp edges or corners		N/A
8.5	Safeguards against moving parts		P
8.5.1	Fingers, jewellery, clothing, hair, etc., contact with MS2 or MS3 parts	System DC fan considered as MS3 energy source and closed by metal enclosure.	P
	MS2 or MS3 part required to be accessible for the function of the equipment	Hazardous moving parts of equipment are adequately enclosed and guarded.	P
	Moving MS3 parts only accessible to skilled person		P
8.5.2	Instructional safeguard.....:		N/A
8.5.4	Special categories of equipment containing moving parts		N/A
8.5.4.1	General		N/A
8.5.4.2	Equipment containing work cells with MS3 parts		N/A
8.5.4.2.1	Protection of persons in the work cell		N/A
8.5.4.2.2	Access protection override		N/A
8.5.4.2.2.1	Override system		N/A
8.5.4.2.2.2	Visual indicator		N/A
8.5.4.2.3	Emergency stop system		N/A
	Maximum stopping distance from the point of activation (m).....:		N/A
	Space between end point and nearest fixed mechanical part (mm).....:		N/A
8.5.4.2.4	Endurance requirements		N/A
	Mechanical system subjected to 100 000 cycles of operation		N/A
	- Mechanical function check and visual inspection		N/A
	- Cable assembly.....:		N/A
8.5.4.3	Equipment having electromechanical device for destruction of media		N/A
8.5.4.3.1	Equipment safeguards		N/A
8.5.4.3.2	Instructional safeguards against moving parts.....:		N/A
8.5.4.3.3	Disconnection from the supply		N/A
8.5.4.3.4	Cut type and test force (N).....:		N/A

IEC 62368-1			
Clause	Requirement + Test	Result - Remark	Verdict
8.5.4.3.5	Compliance		N/A
8.5.5	High pressure lamps		N/A
	Explosion test.....:		N/A
8.5.5.3	Glass particles dimensions (mm)		N/A
8.6	Stability of equipment		P
8.6.1	General	Equipment mass is MS3 energy source.	P
	Instructional safeguard.....:	Not applicable.	N/A
8.6.2	Static stability		P
8.6.2.2	Static stability test	Unit does not overbalance at 10°.	P
8.6.2.3	Downward force test		N/A
8.6.3	Relocation stability		N/A
	Wheels diameter (mm)		—
	Tilt test		N/A
8.6.4	Glass slide test		N/A
8.6.5	Horizontal force test		N/A
8.7	Equipment mounted to wall, ceiling or other structure		N/A
8.7.1	Mount means type		N/A
8.7.2	Test methods		N/A
	Test 1, additional downwards force (N).....:		N/A
	Test 2, number of attachment points and test force (N).....:		N/A
	Test 3 Nominal diameter (mm) and applied torque (Nm).....:		N/A
8.8	Handles strength		P
8.8.1	General		P
8.8.2	Handle strength test		P
	Number of handles.....:	2	—
	Force applied (N)	433 for each handle.	—
8.9	Wheels or casters attachment requirements		N/A
8.9.2	Pull test		N/A
8.10	Carts, stands and similar carriers		N/A
8.10.1	General		N/A
8.10.2	Marking and instructions.....:		N/A

IEC 62368-1			
Clause	Requirement + Test	Result - Remark	Verdict
8.10.3	Cart, stand or carrier loading test		N/A
	Loading force applied (N)		N/A
8.10.4	Cart, stand or carrier impact test		N/A
8.10.5	Mechanical stability		N/A
	Force applied (N)		—
8.10.6	Thermoplastic temperature stability		N/A
8.11	Mounting means for slide-rail mounted equipment (SRME)		N/A
8.11.1	General		N/A
8.11.2	Requirements for slide rails		N/A
	Instructional Safeguard		N/A
8.11.3	Mechanical strength test		N/A
8.11.3.1	Downward force test, force (N) applied		N/A
8.11.3.2	Lateral push force test		N/A
8.11.3.3	Integrity of slide rail end stops		N/A
8.11.4	Compliance		N/A
8.12	Telescoping or rod antennas		N/A
	Button/ball diameter (mm)		—

9	THERMAL BURN INJURY		P
9.2	Thermal energy source classifications		P
9.3	Touch temperature limits		P
9.3.1	Touch temperatures of accessible parts	(See appended table)	P
9.3.2	Test method and compliance		P
9.4	Safeguards against thermal energy sources		P
9.5	Requirements for safeguards		N/A
9.5.1	Equipment safeguard		N/A
9.5.2	Instructional safeguard		N/A
9.6	Requirements for wireless power transmitters		N/A
9.6.1	General		N/A
9.6.2	Specification of the foreign objects		N/A
9.6.3	Test method and compliance	(See appended table 9.6)	N/A

10	RADIATION		P
10.2	Radiation energy source classification		P

IEC 62368-1			
Clause	Requirement + Test	Result - Remark	Verdict
10.2.1	General classification		P
	Lasers	Optical transceiver and LEDs are RS1.	—
	Lamps and lamp systems		—
	Image projectors		—
	X-Ray		—
	Personal music player		—
10.3	Safeguards against laser radiation		N/A
	The standard(s) equipment containing laser(s) comply		N/A
10.4	Safeguards against optical radiation from lamps and lamp systems (including LED types)		P
10.4.1	General requirements		P
	Instructional safeguard provided for accessible radiation level needs to exceed		P
	Risk group marking and location	LEDs only as indicator.	P
	Information for safe operation and installation		P
10.4.2	Requirements for enclosures		N/A
	UV radiation exposure		N/A
10.4.3	Instructional safeguard		N/A
10.5	Safeguards against X-radiation		N/A
10.5.1	Requirements		N/A
	Instructional safeguard for skilled persons		—
10.5.3	Maximum radiation (pA/kg).....	(See appended tables B.3 & B.4)	—
10.6	Safeguards against acoustic energy sources		N/A
10.6.1	General		N/A
10.6.2	Classification		N/A
	Acoustic output $L_{Aeq,T}$, dB(A).....		N/A
	Unweighted RMS output voltage (mV).....		N/A
	Digital output signal (dBFS)		N/A
10.6.3	Requirements for dose-based systems		N/A
10.6.3.1	General requirements		N/A
10.6.3.2	Dose-based warning and automatic decrease		N/A
10.6.3.3	Exposure-based warning and requirements		N/A
	30 s integrated exposure level (MEL30)		N/A

IEC 62368-1			
Clause	Requirement + Test	Result - Remark	Verdict
	Warning for MEL \geq 100 dB(A)		N/A
10.6.4	Measurement methods		N/A
10.6.5	Protection of persons		N/A
	Instructional safeguards		N/A
10.6.6	Requirements for listening devices (headphones, earphones, etc.)		N/A
10.6.6.1	Corded listening devices with analogue input		N/A
	Listening device input voltage (mV).....		N/A
10.6.6.2	Corded listening devices with digital input		N/A
	Max. acoustic output $L_{Aeq,T}$, dB(A)		N/A
10.6.6.3	Cordless listening devices		N/A
	Max. acoustic output $L_{Aeq,T}$, dB(A)		N/A

B	NORMAL OPERATING CONDITION TESTS, ABNORMAL OPERATING CONDITION TESTS AND SINGLE FAULT CONDITION TESTS		P
B.1	General		P
B.1.5	Temperature measurement conditions	(See appended table B.1.5)	P
B.2	Normal operating conditions		P
B.2.1	General requirements	(See Test Item Particulars and appended test tables)	P
	Audio Amplifiers and equipment with audio amplifiers.....		N/A
B.2.3	Supply voltage and tolerances	+/-10%	P
B.2.5	Input test	(See appended table B.2.5)	P
B.3	Simulated abnormal operating conditions		P
B.3.1	General		P
B.3.2	Covering of ventilation openings	(See appended table B.3, B.4)	P
	Instructional safeguard.....		N/A
B.3.3	DC mains polarity test		N/A
B.3.4	Setting of voltage selector		N/A
B.3.5	Maximum load at output terminals	(See appended table B.3, B.4)	P
B.3.6	Reverse battery polarity	Impossible	N/A
B.3.7	Audio amplifier abnormal operating conditions		N/A
B.3.8	Safeguards functional during and after abnormal operating conditions	(See appended table B.3, B.4)	P
B.4	Simulated single fault conditions		P

IEC 62368-1			
Clause	Requirement + Test	Result - Remark	Verdict
B.4.1	General		P
B.4.2	Temperature controlling device		N/A
B.4.3	Blocked motor test	Certified DC fan used.	P
B.4.4	Functional insulation		N/A
B.4.4.1	Short circuit of clearances for functional insulation		N/A
B.4.4.2	Short circuit of creepage distances for functional insulation		N/A
B.4.4.3	Short circuit of functional insulation on coated printed boards		N/A
B.4.5	Short-circuit and interruption of electrodes in tubes and semiconductors		N/A
B.4.6	Short circuit or disconnection of passive components		N/A
B.4.7	Continuous operation of components		N/A
B.4.8	Compliance during and after single fault conditions:	(See appended table B.3, B.4)	P
B.4.9	Battery charging and discharging under single fault conditions	(See Annex M)	P
C	UV RADIATION		N/A
C.1	Protection of materials in equipment from UV radiation		N/A
C.1.2	Requirements		N/A
C.1.3	Test method		N/A
C.2	UV light conditioning test		N/A
C.2.1	Test apparatus		N/A
C.2.2	Mounting of test samples		N/A
C.2.3	Carbon-arc light-exposure test		N/A
C.2.4	Xenon-arc light-exposure test		N/A
D	TEST GENERATORS		N/A
D.1	Impulse test generators		N/A
D.2	Antenna interface test generator		N/A
D.3	Electronic pulse generator		N/A
E	TEST CONDITIONS FOR EQUIPMENT CONTAINING AUDIO AMPLIFIERS		N/A
E.1	Electrical energy source classification for audio signals		N/A
	Maximum non-clipped output power (W)		—
	Rated load impedance (Ω)		—
	Open-circuit output voltage (V)		—

IEC 62368-1			
Clause	Requirement + Test	Result - Remark	Verdict
	Instructional safeguard.....:		—
E.2	Audio amplifier normal operating conditions		N/A
	Audio signal source type.....:		—
	Audio output power (W).....:		—
	Audio output voltage (V).....:		—
	Rated load impedance (Ω).....:		—
	Requirements for temperature measurement		N/A
E.3	Audio amplifier abnormal operating conditions		N/A
F	EQUIPMENT MARKINGS, INSTRUCTIONS, AND INSTRUCTIONAL SAFEGUARDS		P
F.1	General		P
	Language	Operating / safety instructions made available to the user. Safety instructions in English. Other languages will be provided when submitted for National Approval.	—
F.2	Letter symbols and graphical symbols		P
F.2.1	Letter symbols according to IEC60027-1		P
F.2.2	Graphic symbols according to IEC, ISO or manufacturer specific		P
F.3	Equipment markings		P
F.3.1	Equipment marking locations		P
F.3.2	Equipment identification markings		P
F.3.2.1	Manufacturer identification	Hangzhou Hikvision Digital Technology Co., Ltd.	P
F.3.2.2	Model identification	See model list.	P
F.3.3	Equipment rating markings		P
F.3.3.1	Equipment with direct connection to mains		P
F.3.3.2	Equipment without direct connection to mains		N/A
F.3.3.3	Nature of the supply voltage	AC	P
F.3.3.4	Rated voltage.....	100 V a.c.-240 V a.c.	P
F.3.3.5	Rated frequency.....	60/50 Hz	P
F.3.3.6	Rated current or rated power	7-3,5 A x 2	P
F.3.3.7	Equipment with multiple supply connections		N/A
F.3.4	Voltage setting device		N/A
F.3.5	Terminals and operating devices		N/A

IEC 62368-1			
Clause	Requirement + Test	Result - Remark	Verdict
F.3.5.1	Mains appliance outlet and socket-outlet markings		N/A
F.3.5.2	Switch position identification marking	Evaluated in internal power supply test report.	P
F.3.5.3	Replacement fuse identification and rating markings	Evaluated in internal power supply test report.	P
	Instructional safeguards for neutral fuse.....		N/A
F.3.5.4	Replacement battery identification marking.....		N/A
F.3.5.5	Neutral conductor terminal		N/A
F.3.5.6	Terminal marking location		P
F.3.6	Equipment markings related to equipment classification		P
F.3.6.1	Class I equipment		P
F.3.6.1.1	Protective earthing conductor terminal	Certified appliance inlet used.	P
F.3.6.1.2	Protective bonding conductor terminals	Evaluated in internal power supply test report.	P
F.3.6.2	Equipment class marking.....		N/A
F.3.6.3	Functional earthing terminal marking.....		N/A
F.3.7	Equipment IP rating marking.....	IPX0 not marked	N/A
F.3.8	External power supply output marking.....		N/A
F.3.9	Durability, legibility and permanence of marking		P
F.3.10	Test for permanence of markings		P
F.4	Instructions		P
	a) Information prior to installation and initial use		P
	b) Equipment for use in locations where children not likely to be present		P
	c) Instructions for installation and interconnection		P
	d) Equipment intended for use only in restricted access area		N/A
	e) Equipment intended to be fastened in place		N/A
	f) Instructions for audio equipment terminals		N/A
	g) Protective earthing used as a safeguard		P
	h) Protective conductor current exceeding ES2 limits		N/A
	i) Graphic symbols used on equipment		P
	j) Permanently connected equipment not provided with all-pole mains switch		N/A

IEC 62368-1			
Clause	Requirement + Test	Result - Remark	Verdict
	k) Replaceable components or modules providing safeguard function		N/A
	l) Equipment containing insulating liquid		N/A
	m) Installation instructions for outdoor equipment		N/A
F.5	Instructional safeguards		P
G	COMPONENTS		P
G.1	Switches		P
G.1.1	General	Evaluated in internal power supply test report.	P
G.1.2	Ratings, endurance, spacing, maximum load		N/A
G.1.3	Test method and compliance		N/A
G.2	Relays		P
G.2.1	Requirements	Evaluated in internal power supply test report.	P
G.2.2	Overload test		N/A
G.2.3	Relay controlling connectors supplying power to other equipment		N/A
G.2.4	Test method and compliance		N/A
G.3	Protective devices		P
G.3.1	Thermal cut-offs		N/A
	Thermal cut-outs separately approved according to IEC 60730 with conditions indicated in a) & b)		N/A
	Thermal cut-outs tested as part of the equipment as indicated in c)		N/A
G.3.1.2	Test method and compliance		N/A
G.3.2	Thermal links		N/A
G.3.2.1	a) Thermal links tested separately according to IEC 60691 with specifics		N/A
	b) Thermal links tested as part of the equipment		N/A
G.3.2.2	Test method and compliance		N/A
G.3.3	PTC thermistors		N/A
G.3.4	Overcurrent protection devices	Evaluated in internal power supply test report.	P
G.3.5	Safeguards components not mentioned in G.3.1 to G.3.4		N/A
G.3.5.1	Non-resettable devices suitably rated and marking provided		N/A
G.3.5.2	Single faults conditions		N/A

IEC 62368-1			
Clause	Requirement + Test	Result - Remark	Verdict
G.4	Connectors		P
G.4.1	Spacings		P
G.4.2	Mains connector configuration	See table 4.1.2.	P
G.4.3	Plug is shaped that insertion into mains socket-outlets or appliance coupler is unlikely		P
G.5	Wound components		P
G.5.1	Wire insulation in wound components	Evaluated in internal power supply test report.	P
G.5.1.2	Protection against mechanical stress		N/A
G.5.2	Endurance test		N/A
G.5.2.1	General test requirements		N/A
G.5.2.2	Heat run test		N/A
	Test time (days per cycle)		—
	Test temperature (°C)		—
G.5.2.3	Wound components supplied from the mains		N/A
G.5.2.4	No insulation breakdown		N/A
G.5.3	Transformers	Evaluated in internal power supply test report.	P
G.5.3.1	Compliance method	Evaluated in internal power supply test report.	P
	Position	Evaluated in internal power supply test report.	P
	Method of protection	Evaluated in internal power supply test report.	P
G.5.3.2	Insulation	Evaluated in internal power supply test report.	P
	Protection from displacement of windings		—
G.5.3.3	Transformer overload tests	Evaluated in internal power supply test report.	P
G.5.3.3.1	Test conditions	Evaluated in internal power supply test report.	P
G.5.3.3.2	Winding temperatures	Evaluated in internal power supply test report.	P
G.5.3.3.3	Winding temperatures - alternative test method		N/A
G.5.3.4	Transformers using FIW		N/A
G.5.3.4.1	General		N/A
	FIW wire nominal diameter		—
G.5.3.4.2	Transformers with basic insulation only		N/A

IEC 62368-1			
Clause	Requirement + Test	Result - Remark	Verdict
G.5.3.4.3	Transformers with double insulation or reinforced insulation		N/A
G.5.3.4.4	Transformers with FIW wound on metal or ferrite core		N/A
G.5.3.4.5	Thermal cycling test and compliance		N/A
G.5.3.4.6	Partial discharge test		N/A
G.5.3.4.7	Routine test		N/A
G.5.4	Motors		P
G.5.4.1	General requirements		P
G.5.4.2	Motor overload test conditions		N/A
G.5.4.3	Running overload test		N/A
G.5.4.4.2	Locked-rotor overload test		N/A
	Test duration (days)		—
G.5.4.5	Running overload test for DC motors		N/A
G.5.4.5.2	Tested in the unit		N/A
G.5.4.5.3	Alternative method		N/A
G.5.4.6	Locked-rotor overload test for DC motors		P
G.5.4.6.2	Tested in the unit		P
	Maximum Temperature	See appended table B.3, B.4	P
G.5.4.6.3	Alternative method		N/A
G.5.4.7	Motors with capacitors		N/A
G.5.4.8	Three-phase motors		N/A
G.5.4.9	Series motors		N/A
	Operating voltage		—
G.6	Wire Insulation		P
G.6.1	General		P
G.6.2	Enamelled winding wire insulation		N/A
G.7	Mains supply cords		N/A
G.7.1	General requirements		N/A
	Type		—
G.7.2	Cross sectional area (mm ² or AWG).....		N/A
G.7.3	Cord anchorages and strain relief for non-detachable power supply cords		N/A
G.7.3.2	Cord strain relief		N/A
G.7.3.2.1	Requirements		N/A

IEC 62368-1			
Clause	Requirement + Test	Result - Remark	Verdict
	Strain relief test force (N)		N/A
G.7.3.2.2	Strain relief mechanism failure		N/A
G.7.3.2.3	Cord sheath or jacket position, distance (mm)		N/A
G.7.3.2.4	Strain relief and cord anchorage material		N/A
G.7.4	Cord Entry		N/A
G.7.5	Non-detachable cord bend protection		N/A
G.7.5.1	Requirements		N/A
G.7.5.2	Test method and compliance		N/A
	Overall diameter or minor overall dimension, <i>D</i> (mm)		—
	Radius of curvature after test (mm)		—
G.7.6	Supply wiring space		N/A
G.7.6.1	General requirements		N/A
G.7.6.2	Stranded wire		N/A
G.7.6.2.1	Requirements		N/A
G.7.6.2.2	Test with 8 mm strand		N/A
G.8	Varistors		N/A
G.8.1	General requirements		N/A
G.8.2	Safeguards against fire		N/A
G.8.2.1	General		N/A
G.8.2.2	Varistor overload test		N/A
G.8.2.3	Temporary overvoltage test		N/A
G.9	Integrated circuit (IC) current limiters		P
G.9.1	Requirements	For USB ports.	P
	IC limiter output current (max. 5A)	See table 4.1.2	—
	Manufacturers' defined drift	See table 4.1.2	—
G.9.2	Test Program		—
G.9.3	Compliance		N/A
G.10	Resistors		N/A
G.10.1	General		N/A
G.10.2	Conditioning		N/A
G.10.3	Resistor test		N/A
G.10.4	Voltage surge test		N/A
G.10.5	Impulse test		N/A
G.10.6	Overload test		N/A

IEC 62368-1			
Clause	Requirement + Test	Result - Remark	Verdict
G.11	Capacitors and RC units		P
G.11.1	General requirements	Evaluated in internal power supply test report.	P
G.11.2	Conditioning of capacitors and RC units		P
G.11.3	Rules for selecting capacitors		N/A
G.12	Optocouplers		P
	Optocouplers comply with IEC 60747-5-5 with specifics	Evaluated in internal power supply test report.	P
	Type test voltage $V_{ini,a}$	Min. 4000	—
	Routine test voltage, $V_{ini,b}$	Min. 4000	—
G.13	Printed boards		P
G.13.1	General requirements		P
G.13.2	Uncoated printed boards		P
G.13.3	Coated printed boards		N/A
G.13.4	Insulation between conductors on the same inner surface		N/A
G.13.5	Insulation between conductors on different surfaces		N/A
	Distance through insulation.....		N/A
	Number of insulation layers (pcs)		—
G.13.6	Tests on coated printed boards		N/A
G.13.6.1	Sample preparation and preliminary inspection		N/A
G.13.6.2	Test method and compliance		N/A
G.14	Coating on components terminals		N/A
G.14.1	Requirements	(See Clause G.13)	N/A
G.15	Pressurized liquid filled components		N/A
G.15.1	Requirements		N/A
G.15.2	Test methods and compliance		N/A
G.15.2.1	Hydrostatic pressure test		N/A
G.15.2.2	Creep resistance test		N/A
G.15.2.3	Tubing and fittings compatibility test		N/A
G.15.2.4	Vibration test		N/A
G.15.2.5	Thermal cycling test		N/A
G.15.2.6	Force test		N/A
G.15.3	Compliance		N/A
G.16	IC including capacitor discharge function (ICX)		N/A

IEC 62368-1			
Clause	Requirement + Test	Result - Remark	Verdict
G.16.1	Condition for fault tested is not required	No such part	N/A
	ICX with associated circuitry tested in equipment		N/A
	ICX tested separately		N/A
G.16.2	Tests		N/A
	Smallest capacitance and smallest resistance specified by ICX manufacturer for impulse test		—
	Mains voltage that impulses to be superimposed on		—
	Largest capacitance and smallest resistance for ICX tested by itself for 10000 cycles test.....		—
G.16.3	Capacitor discharge test		N/A
H	CRITERIA FOR TELEPHONE RINGING SIGNALS		N/A
H.1	General		N/A
H.2	Method A		N/A
H.3	Method B		N/A
H.3.1	Ringling signal		N/A
H.3.1.1	Frequency (Hz)		—
H.3.1.2	Voltage (V)		—
H.3.1.3	Cadence; time (s) and voltage (V)		—
H.3.1.4	Single fault current (mA):		—
H.3.2	Tripping device and monitoring voltage		N/A
H.3.2.1	Conditions for use of a tripping device or a monitoring voltage		N/A
H.3.2.2	Tripping device		N/A
H.3.2.3	Monitoring voltage (V)		N/A
J	INSULATED WINDING WIRES FOR USE WITHOUT INTERLEAVED INSULATION		P
J.1	General		P
	Winding wire insulation	Evaluated in internal power supply test report.	—
	Solid round winding wire, diameter (mm)		N/A
	Solid square and rectangular (flatwise bending) winding wire, cross-sectional area (mm ²)		N/A
J.2/J.3	Tests and Manufacturing		—
K	SAFETY INTERLOCKS		N/A
K.1	General requirements		N/A
	Instructional safeguard.....		N/A

IEC 62368-1			
Clause	Requirement + Test	Result - Remark	Verdict
K.2	Components of safety interlock safeguard mechanism		N/A
K.3	Inadvertent change of operating mode		N/A
K.4	Interlock safeguard override		N/A
K.5	Fail-safe		N/A
K.5.1	Under single fault condition		N/A
K.6	Mechanically operated safety interlocks		N/A
K.6.1	Endurance requirement		N/A
K.6.2	Test method and compliance		N/A
K.7	Interlock circuit isolation		N/A
K.7.1	Separation distance for contact gaps & interlock circuit elements		N/A
	In circuit connected to mains, separation distance for contact gaps (mm)		N/A
	In circuit isolated from mains, separation distance for contact gaps (mm)		N/A
	Electric strength test before and after the test of K.7.2	(See appended table 5.4.9)	N/A
K.7.2	Overload test, Current (A)		N/A
K.7.3	Endurance test		N/A
K.7.4	Electric strength test		N/A
L	DISCONNECT DEVICES		P
L.1	General requirements		P
L.2	Permanently connected equipment		N/A
L.3	Parts that remain energized		P
L.4	Single-phase equipment	Appliance inlet Disconnect device disconnects all poles simultaneously.	P
L.5	Three-phase equipment		N/A
L.6	Switches as disconnect devices		N/A
L.7	Plugs as disconnect devices		N/A
L.8	Multiple power sources		P
	Instructional safeguard.....	Each disconnect device is marked to indicate the proper method for total power disconnection and all disconnects are grouped together.	P

IEC 62368-1			
Clause	Requirement + Test	Result - Remark	Verdict
M	EQUIPMENT CONTAINING BATTERIES AND THEIR PROTECTION CIRCUITS		P
M.1	General requirements		P
M.2	Safety of batteries and their cells		P
M.2.1	Batteries and their cells comply with relevant IEC standards	See table 4.1.2	P
M.3	Protection circuits for batteries provided within the equipment		P
M.3.1	Requirements		P
M.3.2	Test method		P
	Overcharging of a rechargeable battery		N/A
	Excessive discharging		P
	Unintentional charging of a non-rechargeable battery		P
	Reverse charging of a rechargeable battery		N/A
M.3.3	Compliance	(See appended table M.3)	P
M.4	Additional safeguards for equipment containing a portable secondary lithium battery		N/A
M.4.1	General	The battery is non-rechargeable.	N/A
M.4.2	Charging safeguards		N/A
M.4.2.1	Requirements		N/A
M.4.2.2	Compliance		N/A
M.4.3	Fire enclosure		N/A
M.4.4	Drop test of equipment containing a secondary lithium battery		N/A
M.4.4.2	Preparation and procedure for the drop test		N/A
M.4.4.3	Drop, Voltage on reference and dropped batteries (V); voltage difference during 24 h period (%):		N/A
M.4.4.4	Check of the charge/discharge function		N/A
M.4.4.5	Charge / discharge cycle test		N/A
M.4.4.6	Compliance		N/A
M.5	Risk of burn due to short-circuit during carrying		N/A
M.5.1	Requirement		N/A
M.5.2	Test method and compliance		N/A
M.6	Safeguards against short-circuits		P
M.6.1	External and internal faults	Certified coin battery	P
M.6.2	Compliance		P
M.7	Risk of explosion from lead acid and NiCd batteries		N/A

IEC 62368-1			
Clause	Requirement + Test	Result - Remark	Verdict
M.7.1	Ventilation preventing explosive gas concentration		N/A
	Calculated hydrogen generation rate		N/A
M.7.2	Test method and compliance		N/A
	Minimum air flow rate, Q (m ³ /h)		N/A
M.7.3	Ventilation tests		N/A
M.7.3.1	General		N/A
M.7.3.2	Ventilation test – alternative 1		N/A
	Hydrogen gas concentration (%)		N/A
M.7.3.3	Ventilation test – alternative 2		N/A
	Obtained hydrogen generation rate		N/A
M.7.3.4	Ventilation test – alternative 3		N/A
	Hydrogen gas concentration (%)		N/A
M.7.4	Marking		N/A
M.8	Protection against internal ignition from external spark sources of batteries with aqueous electrolyte		N/A
M.8.1	General		N/A
M.8.2	Test method		N/A
M.8.2.1	General		N/A
M.8.2.2	Estimation of hypothetical volume V_z (m ³ /s)		—
M.8.2.3	Correction factors.....		—
M.8.2.4	Calculation of distance d (mm)		—
M.9	Preventing electrolyte spillage		N/A
M.9.1	Protection from electrolyte spillage		N/A
M.9.2	Tray for preventing electrolyte spillage		N/A
M.10	Instructions to prevent reasonably foreseeable misuse		P
	Instructional safeguard.....	Provided in the manual	P
N	ELECTROCHEMICAL POTENTIALS		P
	Material(s) used	Closed loop connectors: Tin plated (Sn) Nuts and stud terminals: Steel and Zinc plated Chassis: Al/Fe	—
O	MEASUREMENT OF CREEPAGE DISTANCES AND CLEARANCES		P
	Value of X (mm)	Refer to the certified power supply.	—

IEC 62368-1			
Clause	Requirement + Test	Result - Remark	Verdict
P	SAFEGUARDS AGAINST CONDUCTIVE OBJECTS		P
P.1	General		P
P.2	Safeguards against entry or consequences of entry of a foreign object		P
P.2.1	General		P
P.2.2	Safeguards against entry of a foreign object		P
	Location and Dimensions (mm)	Not exceed 5mm in any dimension.	—
P.2.3	Safeguards against the consequences of entry of a foreign object	Unit top cover extended outward, and no bare conductive parts of ES3 or PS3 circuits within the projected volume as depicted in Figure P.3.	P
P.2.3.1	Safeguard requirements		N/A
	The ES3 and PS3 keep-out volume in Figure P.3 not applicable to transportable equipment		N/A
	Transportable equipment with metalized plastic parts		N/A
P.2.3.2	Consequence of entry test		N/A
P.3	Safeguards against spillage of internal liquids		N/A
P.3.1	General		N/A
P.3.2	Determination of spillage consequences		N/A
P.3.3	Spillage safeguards		N/A
P.3.4	Compliance		N/A
P.4	Metallized coatings and adhesives securing parts		N/A
P.4.1	General		N/A
P.4.2	Tests		N/A
	Conditioning, T _c (°C)		—
	Duration (weeks)		—
Q	CIRCUITS INTENDED FOR INTERCONNECTION WITH BUILDING WIRING		P
Q.1	Limited power sources		P
Q.1.1	Requirements		P
	a) Inherently limited output		N/A
	b) Impedance limited output	VGA port	P
	c) Regulating network limited output		N/A
	d) Overcurrent protective device limited output		N/A
	e) IC current limiter complying with G.9	USB ports.	P
Q.1.2	Test method and compliance	(See appended table Q.1)	P

IEC 62368-1			
Clause	Requirement + Test	Result - Remark	Verdict
	Current rating of overcurrent protective device (A)		N/A
Q.2	Test for external circuits – paired conductor cable		N/A
	Maximum output current (A)		N/A
	Current limiting method.....		—
R	LIMITED SHORT CIRCUIT TEST		N/A
R.1	General		N/A
R.2	Test setup		N/A
	Overcurrent protective device for test.....		—
R.3	Test method		N/A
	Cord/cable used for test.....		—
R.4	Compliance		N/A
S	TESTS FOR RESISTANCE TO HEAT AND FIRE		P
S.1	Flammability test for fire enclosures and fire barrier materials of equipment where the steady state power does not exceed 4 000 W		N/A
	Samples, material		—
	Wall thickness (mm).....		—
	Conditioning (°C).....		—
	Test flame according to IEC 60695-11-5 with conditions as set out		N/A
	- Material not consumed completely		N/A
	- Material extinguishes within 30s		N/A
	- No burning of layer or wrapping tissue		N/A
S.2	Flammability test for fire enclosure and fire barrier integrity		N/A
	Samples, material		—
	Wall thickness (mm).....		—
	Conditioning (°C).....		—
S.3	Flammability test for the bottom of a fire enclosure		N/A
S.3.1	Mounting of samples		N/A
S.3.2	Test method and compliance		N/A
	Mounting of samples		—
	Wall thickness (mm).....		—
S.4	Flammability classification of materials	See appended table 4.1.2	P

IEC 62368-1			
Clause	Requirement + Test	Result - Remark	Verdict
S.5	Flammability test for fire enclosure materials of equipment with a steady state power exceeding 4 000 W		N/A
	Samples, material		—
	Wall thickness (mm).....		—
	Conditioning (°C).....		—
T	MECHANICAL STRENGTH TESTS		P
T.1	General		P
T.2	Steady force test, 10 N		N/A
T.3	Steady force test, 30 N		N/A
T.4	Steady force test, 100 N		N/A
T.5	Steady force test, 250 N	(See appended table T.5)	P
T.6	Enclosure impact test	(See appended table T.6)	P
	Fall test		P
	Swing test		N/A
T.7	Drop test		N/A
T.8	Stress relief test		N/A
T.9	Glass Impact Test.....		N/A
T.10	Glass fragmentation test		N/A
	Number of particles counted		N/A
T.11	Test for telescoping or rod antennas		N/A
	Torque value (Nm)		N/A
U	MECHANICAL STRENGTH OF CATHODE RAY TUBES (CRT) AND PROTECTION AGAINST THE EFFECTS OF IMPLOSION		N/A
U.1	General		N/A
	Instructional safeguard :		N/A
U.2	Test method and compliance for non-intrinsically protected CRTs		N/A
U.3	Protective screen		N/A
V	DETERMINATION OF ACCESSIBLE PARTS		P
V.1	Accessible parts of equipment		P
V.1.1	General	Not accessible without tool	P
V.1.2	Surfaces and openings tested with jointed test probes		P
V.1.3	Openings tested with straight unjointed test probes		P
V.1.4	Plugs, jacks, connectors tested with blunt probe		N/A

IEC 62368-1			
Clause	Requirement + Test	Result - Remark	Verdict
V.1.5	Slot openings tested with wedge probe		N/A
V.1.6	Terminals tested with rigid test wire		N/A
V.2	Accessible part criterion		P
X	ALTERNATIVE METHOD FOR DETERMINING CLEARANCES FOR INSULATION IN CIRCUITS CONNECTED TO AN AC MAINS NOT EXCEEDING 420 V PEAK (300 V RMS)		N/A
	Clearance		N/A
Y	CONSTRUCTION REQUIREMENTS FOR OUTDOOR ENCLOSURES		N/A
Y.1	General		N/A
Y.2	Resistance to UV radiation		N/A
Y.3	Resistance to corrosion		N/A
Y.3.1	Metallic parts of outdoor enclosures are resistant to effects of water-borne contaminants by		N/A
Y.3.2	Test apparatus		N/A
Y.3.3	Water – saturated sulphur dioxide atmosphere		N/A
Y.3.4	Test procedure		N/A
Y.3.5	Compliance		N/A
Y.4	Gaskets		N/A
Y.4.1	General		N/A
Y.4.2	Gasket tests		N/A
Y.4.3	Tensile strength and elongation tests		N/A
	Alternative test methods		N/A
Y.4.4	Compression test		N/A
Y.4.5	Oil resistance		N/A
Y.4.6	Securing means		N/A
Y.5	Protection of equipment within an outdoor enclosure		N/A
Y.5.1	General		N/A
Y.5.2	Protection from moisture		N/A
	Relevant tests of IEC 60529 or Y.5.3		N/A
Y.5.3	Water spray test		N/A
Y.5.4	Protection from plants and vermin		N/A
Y.5.5	Protection from excessive dust		N/A
Y.5.5.1	General		N/A
Y.5.5.2	IP5X equipment		N/A
Y.5.5.3	IP6X equipment		N/A

IEC 62368-1			
Clause	Requirement + Test	Result - Remark	Verdict
Y.6	Mechanical strength of enclosures		N/A
Y.6.1	General		N/A
Y.6.2	Impact test.....:		N/A

IEC 62368-1			
Clause	Requirement + Test	Result - Remark	Verdict

5.2		TABLE: Classification of electrical energy sources					P
Supply Voltage	Location (e.g. circuit designation)	Test conditions	Parameters				ES Class
			U (V)	I (mA)	Type ¹⁾	Additional Info ²⁾	
--	--	Normal	--	--	--	--	--
		Abnormal -	--	--	--	--	--
		Single fault -	--	--	--	--	--
Supplementary information:							
1) Type: Steady state (SS), Capacitance (CP), Single pulse (SP), Repetitive pulses (RP), etc.							
2) Additional Info: Frequency, Pulse duration, Pulse off time, Capacitance value, etc.							
Class I equipment is intended to be supplied by internal switching power supply modules with ES1 output and no ES2 or ES3 voltage is generated within unit. All output circuits are classified as ES1 and no operator access to energized parts.							

5.4.1.8		TABLE: Working voltage measurement			P
Location		RMS voltage (V)	Peak voltage (V)	Frequency (Hz)	Comments
--		--	--	--	--
Supplementary information:					
Evaluated in internal power supply test report.					

5.4.1.10.2		TABLE: Vicat softening temperature of thermoplastics			N/A
Method.....		ISO 306 / B50			—
Object/ Part No./Material	Manufacturer/trademark	Thickness (mm)	T softening (°C)		
--	--	--	--		
Supplementary information:					

5.4.1.10.3		TABLE: Ball pressure test of thermoplastics			P
Allowed impression diameter (mm)		≤ 2 mm			—
Object/Part No./Material	Manufacturer/trademark	Thickness (mm)	Test temperature (°C)	Impression diameter (mm)	
--	--	--	--	--	
Supplementary information:					
Evaluated in internal power supply test report.					

IEC 62368-1			
Clause	Requirement + Test	Result - Remark	Verdict

5.4.2, 5.4.3 TABLE: Minimum Clearances/Creepage distance								P
Clearance (cl) and creepage distance (cr) at/of/between:	U_p (V)	U_{rms} (V)	Freq ¹⁾ (Hz)	Required cl (mm)	cl (mm)	E.S. ²⁾ (V)	Required cr (mm)	cr (mm)
Functional:								
--	--	--	--	--	--	--	--	--
Basic/supplementary:								
--	--	--	--	--	--	--	--	--
Reinforced:								
--	--	--	--	--	--	--	--	--
Supplementary information:								
1) Only for frequency above 30 kHz Evaluated in internal power supply report, the power supply is fully wrapped, and the primary circuit is not exposed.								

5.4.4.2 TABLE: Minimum distance through insulation					P
Distance through insulation (DTI) at/of	Peak voltage (V)	Insulation	Required DTI (mm)	Measured DTI (mm)	
--	--	--	--	--	
Supplementary information:					
Evaluated in internal power supply test report.					

5.4.4.9 TABLE: Solid insulation at frequencies >30 kHz							N/A
Insulation material	E_p	Frequency (kHz)	K_R	Thickness d (mm)	Insulation	V_{PW} (Vpk)	
--	--	--	--	--	--	--	
Supplementary information:							

5.4.9 TABLE: Electric strength tests				P
Test voltage applied between:	Voltage shape (Surge, Impulse, AC, DC, etc.)	Test voltage (V)	Breakdown Yes / No	
Primary to Earth (metal enclosure)	DC	2500	No	
Primary to secondary	DC	4000	No	
L/N to plastic enclosure	DC	4000	No	
Supplementary information:				

IEC 62368-1			
Clause	Requirement + Test	Result - Remark	Verdict

5.5.2.2	TABLE: Stored discharge on capacitors					P
Location	Supply voltage (V)	Operating and fault condition ¹⁾	Switch position	Measured voltage (Vpk)	ES Class	
--	--	--	--	--	--	
Supplementary information:						
Evaluated in internal power supply test report. X-capacitors installed for testing: [] bleeding resistor rating: [] ICX: 1) Normal operating condition (e.g., normal operation, or open fuse), SC= short circuit, OC= open circuit						

5.6.6	TABLE: Resistance of protective conductors and terminations				P
Location	Test current (A)	Duration (min)	Voltage drop (V)	Resistance (Ω)	
Earth pin of inlet to farthest metal enclosure	40	2	0,52	0,02	
Supplementary information:					

5.7.4	TABLE: Unearthed accessible parts					P
Location	Operating and fault conditions	Supply Voltage (V)	Parameters			ES class
			Voltage (V_{rms} or V_{pk})	Current (A_{rms} or A_{pk})	Freq. (Hz)	
Plastic enclosure	Normal	264 V a.c.	--	0,005mApk/ 0,004mArms	--	ES1
	Single fault - fuse open	264 V a.c.	--	0,018mApk/ 0,016mArms	--	ES1
Supplementary information:						

5.7.5	TABLE: Earthed accessible conductive part			P
Supply voltage (V)	264V / 60Hz			---
Phase(s)	[X] Single Phase; [] Three Phase: [] Delta [] Wye			---
Power Distribution System	[X] TN [X]TT [] IT			---
Location	Fault Condition No in IEC 60990 clause 6.2.2	Touch current (mA)	Comment	
L/N to metal enclosure	No.1	Normal:	--	

IEC 62368-1			
Clause	Requirement + Test	Result - Remark	Verdict

		2,49mApk Reverse: 2,49mApk	
Supplementary Information:			

5.8	TABLE: Backfeed safeguard in battery backed up supplies					N/A
Location	Supply voltage (V)	Operating and fault condition	Time (s)	Open-circuit voltage (V)	Touch current (A)	ES Class
--	--	--	--	--	--	--
Supplementary information:						
Abbreviation: SC= short circuit, OC= open circuit						

6.2.2	TABLE: Power source circuit classifications					P
Location	Operating and fault condition	Voltage (V)	Current (A)	Max. Power ¹⁾ (W)	Time (S)	PS class
Power input and all internal circuits	--	--	--	--	--	PS3
Supplementary information:						

6.2.3.1	TABLE: Determination of Arcing PIS				P
Location	Open circuit voltage after 3 s (Vpk)	Measured r.m.s current (A)	Calculated value	Arcing PIS? Yes / No	
All primary circuits	--	--	--	Yes	
Supplementary information:					
All primary circuits are considered as Arcing PIS without test.					

6.2.3.2	TABLE: Determination of resistive PIS			P
Location	Operating and fault condition	Dissipate power (W)	Arcing PIS? Yes / No	
All internal circuits	--	--	--	
Supplementary information:				
Abbreviation: SC= short circuit; OC= open circuit				
All internal circuits except primary are considered as Resistive PIS without test.				

IEC 62368-1			
Clause	Requirement + Test	Result - Remark	Verdict

8.5.5	TABLE: High pressure lamp				N/A
Lamp manufacturer	Lamp type	Explosion method	Longest axis of glass particle (mm)	Particle found beyond 1 m Yes / No	
--	--	--	--	--	
Supplementary information:					

9.6	TABLE: Temperature measurements for wireless power transmitters							N/A
Supply voltage (V)..... :							—	
Max. transmit power of transmitter (W)..... :							—	
Foreign objects	w/o receiver and direct contact		with receiver and direct contact		with receiver and at distance of 2 mm		with receiver and at distance of 5 mm	
	Object (°C)	Ambient (°C)	Object (°C)	Ambient (°C)	Object (°C)	Ambient (°C)	Object (°C)	Ambient (°C)
--	--	--	--	--	--	--	--	--
Supplementary information:								

5.4.1.4, 9.3, B.1.5, B.2.6	TABLE: Temperature measurements			P
Supply voltage (V)..... :		90VAC/50Hz	264VAC/60Hz	—
Ambient temperature during test T_{amb} (°C) :		23,7	24,1	—
Maximum measured temperature T of part/at:		T (°C)		Allowed T_{max} (°C)
Testing with one PSUs on model DS-A81024S				
1. AC inlet (PSU)		44,1	45,6	70
2. CX3 BODY(PSU)		51,3	52,7	100
3. CY3 BODY (PSU)		44,3	46,7	110
4.RY1 Body (PSU)		47,2	47,1	85
5. IC6C BODY (PSU)		45,1	46,4	130
6.T2 Coil (PSU)		61,7	67,9	110
7.T2 Core (PSU)		55,6	60,2	110
8.PCB near BD1 (PSU)		67,0	62,8	130
9.Battery (BN-HMB-F1331 REV2.1)		43,7	43,8	100

IEC 62368-1			
Clause	Requirement + Test	Result - Remark	Verdict

10.FAN (BN-HMB-F1331 REV2.1)	44,3	44,3	Ref				
11.PWB near CV133(BN-HMB-F1331 REV2.1)	44,9	45,0	105				
12. Center of the board	40,7	40,8	105				
13. PWB near UN9(BN-HMB-F1331 REV2.1)	47,2	47,2	105				
14. CV70(BN-HMB-F1331 REV2.1)	45,5	45,6	Ref				
15. PWB near U2 (BN-HMB-F1331 REV2.1)	45,9	46,0	105				
16. PWB near U22 (BN-HMB-F1331 REV2.1)	50,5	50,5	105				
17. Internal wiring	43,4	43,4	80				
18. PWB near battery (BN-HMB-F1331 REV2.1)	44,9	45,0	105				
19. PWB near USB port (BN-HMB-F1331 REV2.1)	47,0	47,0	105				
20. Fan connector	43,9	44,0	95				
21. PWB in back board	47,0	47,2	105				
22.Plastic enclosure inside	42,6	42,7	60				
23.Fan guard(unit)	42,0	42,1	61				
24. Metal Handle of fan (unit)	42,7	42,9	61				
25. Plastic Handle of Fan (PSU)*	29,9	30,0	60				
26. Fan guard (PSU)*	35,1	35,8	51				
27. Metal enclosure near ventilated opening*	28,2	28,3	51				
28. Metal enclosure upper the SSDs*	26,5	26,6	51				
29.Plastic enclosure outside*	26,5	26,7	48				
Temperature T of winding:	t ₁ (°C)	R ₁ (Ω)	t ₂ (°C)	R ₂ (Ω)	T (°C)	Allowed T _{max} (°C)	Insulation class
--	--	--	--	--	--	--	--

Supplementary information:

* The test results of touchable surface temperature were considered base on ambient temperature 25°C. Other measured temperature point list in this table has calculated to T_{ma} (40°C).
The limited value of power supply unit temperature refers to the power supply test report.

IEC 62368-1			
Clause	Requirement + Test	Result - Remark	Verdict

B.2.5 TABLE: Input test								P
U (V)	Hz	I (A)	I rated (A)	P (W)	P rated (W)	Fuse No	I fuse (A)	Condition/status
Testing with one PSU on model DS- A81024S								
90	50	5,31	--	473,4	--	F1	5,31	Maximum normal load condition.
100	50	4,66	7	464,7	--	F1	4,66	
240	50	1,87	3,5	445,7	--	F1	1,87	
264	50	1,67	--	439,0	--	F1	1,67	
90	60	5,07	--	453,2	--	F1	5,07	
100	60	4,47	7	445,3	--	F1	4,47	
240	60	1,79	3,5	429,0	--	F1	1,79	
264	60	1,63	--	427,3	--	F1	1,63	
Testing with two PSUs on model DS- A81024S								
90	50	2,61/ 2,49	--	235,0/ 222,5	--	F1	2,61/ 2,49	Maximum normal load condition.
100	50	2,32/ 2,21	7	231,2/ 220,3	--	F1	2,32/ 2,21	
240	50	0,96/ 0,91	3,5	227,2/ 215,0	--	F1	0,96/ 0,91	
264	50	0,86/ 0,84	--	223,3/ 216,4	--	F1	0,86/ 0,84	
90	60	2,52/ 2,39	--	225,7/ 214,3	--	F1	2,52/ 2,39	
100	60	2,24/ 2,11	7	223,1/ 210,2	--	F1	2,24/ 2,11	
240	60	0,92/ 0,87	3,5	217,6/ 205,3	--	F1	0,92/ 0,87	
264	60	0,85/ 0,81	--	218,4/ 206,0	--	F1	0,85/ 0,81	
Supplementary information:								
Equipment may be have rated current or rated power or both. Both should be measured								

B.3, B.4 TABLE: Abnormal operating and fault condition tests							P
Ambient temperature T_{amb} (°C)..... :						23,5	—
Power source for EUT: Manufacturer, model/type, outputrating .. :						See table 4.1.2	—
Component No.	Condition	Supply voltage (V)	Test time	Fuse no.	Fuse current (A)	Observation	

IEC 62368-1			
Clause	Requirement + Test	Result - Remark	Verdict

Test on model DS-A81024S with 2 PSUs						
All inflow exhaust openings	Blocked	264	54min	F1	1,60	Max temperature as below: T2 Coil (PSU): 64,1°C; T2 Core (PSU): 54,9°C; Metal enclosure near ventilated opening: 31,4°C; Ambient: 22,7°C; Unit can work. NB, NF.
USB 2.0 port	Overload	264	1h48min	F1	1,60-> 1,64-> 1,59	Max temperature as below: T2 Coil (PSU): 53,2°C; T2 Core (PSU): 45,8°C; Metal enclosure near ventilated opening: 28,2°C; Ambient: 22,8°C; Unit can work, USB 2.0 port shutdown at load 2,79A. NB, NF.
USB 2.0 port	Sc	264	1min	F1	1,12	Unit can work, USB 2.0 port shutdown, input current decreases. NB, NF.
USB 3.0 port	Overload	264	2h2min	F1	1,60-> 1,69-> 1,56	Max temperature as below: T2 Coil (PSU): 55,3°C; T2 Core (PSU): 48,0°C; Metal enclosure near ventilated opening: 29,3°C; Ambient: 22,9°C; Unit can work, USB 3.0 port shutdown at load 3,2+3,16A. NB, NF.
USB 3.0 port	Sc	264	1min	F1	0,16	Unit shutdown immediately. NB, NF.
Fan 1 (Behind the hard disk)	Locked	264	53min	F1	1,50	Max temperature as below: T2 Coil (PSU): 58,8°C; T2 Core (PSU): 51,7°C; Metal enclosure near ventilated opening: 28,5°C; Ambient: 23,1°C; Unit can work. NB, NF.
Fan 2 (Behind the hard disk)	Locked	264	50min	F1	1,48	Max temperature as below: T2 Coil (PSU): 51,8°C; T2 Core (PSU): 45,7°C; Metal enclosure near ventilated opening: 28,4°C; Ambient: 22,9°C; Unit can work. NB, NF.

IEC 62368-1						
Clause	Requirement + Test			Result - Remark		Verdict
Fan 3 (Behind the hard disk)	Locked	264	1h8min	F1	1,48	Max temperature as below: T2 Coil (PSU): 53,3°C; T2 Core (PSU): 46,6°C; Metal enclosure near ventilated opening: 30,3°C; Ambient: 22,6°C; Unit can work. NB, NF.
Fan 4 (on main board)	Locked	264	56min	F1	1,58	Max temperature as below: T2 Coil (PSU): 51,9°C; T2 Core (PSU): 44,4°C; Metal enclosure near ventilated opening: 28,9°C; Ambient: 22,8°C; Unit can work. NB, NF.
Fan 5 on HDD connected board	Locked	264	1h3min	F1	1,59	Max temperature as below: T2 Coil (PSU): 52,2°C; T2 Core (PSU): 44,6°C; Metal enclosure near ventilated opening: 27,5°C; Ambient: 22,9°C; Unit can work. NB, NF.
Power supply fan	Locked	264	1min	F1	0,14	Unit shutdown immediately. NB, NF.
Light board (SC U1 pin 8 to pin7)	Sc	264	5min	F1	0,22	Unit normal work. NF.
Light board (SC U1 pin 8 to pin6)	Sc	264	5min	F1	0,22	Unit normal work. NF.
Light board (SC U1 pin 8 to pin5)	Sc	264	5min	F1	0,22	Unit normal work. NF.
Light board (SC U1 pin 8 to pin1)	Sc	264	5min	F1	0,22	After Sc, SW2 light keep lighting, and recoverable. NF.
Light board (SC U1 pin 8 to pin2)	Sc	264	5min	F1	0,22	After Sc, SW2 light keep lighting.
Light board (SC U1 pin 8 to pin3)	Sc	264	5min	F1	0,22	Unit normal work. NF.
Light board (SC U1 pin 8 to pin4)	Sc	264	5min	F1	0,22->0,26	After SC, SW1 and SW2 lights shutdown, current increases to 0,26A and

IEC 62368-1			
Clause	Requirement + Test	Result - Remark	Verdict

						recoverable. NF.
Supplementary information:						
Sc=Short circuit. NB – No indication of dielectric breakdown; NF – No Flame.						

M.3	TABLE: Protection circuits for batteries provided within the equipment						P
Is it possible to install the battery in a reverse polarity position?						No	—
Equipment Specification	Charging						
	Voltage (V)			Current (A)			
	100 V a.c.-240 V a.c.			7-3,5 A x 2			
Manufacturer/type	Battery specification						
	Non-rechargeable batteries			Rechargeable batteries			
	Discharging current (A)	Unintentional charging current (A)	Charging		Discharging current (A)	Reverse charging current (A)	
			Voltage (V)	Current (A)			
See table 4.1.2	--	See table 4.1.2	--	--	--	--	
Note: The tests of M.3.2 are applicable only when above appropriate data is not available.							
Specified battery temperature (°C)						60	--
Component No.	Fault condition	Charge/discharge mode	Test time	Temp. (°C)	Current (A)	Voltage (V)	Observation
*	*	*	*	*	*	*	*
Supplementary information:							
Abbreviation: SC= short circuit; OC= open circuit NL= no chemical leakage; NS= no spillage of liquid; NE= no explosion; NF= no emission of flame or expulsion of molten metal. *Test was waived by engineering judgment due to use UL1642 certified button cell and protected by RBA3=1500ohm, RBA5=45300ohm and diode DBA1, all parameters are within the spec of button cell in normal and single fault condition.							

M.4.2	TABLE: Charging safeguards for equipment containing a secondary lithium battery						N/A
Maximum specified charging voltage (V)						--	—
Maximum specified charging current (A)						--	—
Highest specified charging temperature (°C)						--	—
Lowest specified charging temperature (°C)						--	--
Battery manufacturer/type	Operating and fault condition	Measurement			Observation		
		Charging voltage (V)	Charging current (A)	Temp. (°C)			

IEC 62368-1			
Clause	Requirement + Test	Result - Remark	Verdict

--	--	--	--	--	--
Supplementary information: Abbreviation: SC= short circuit; OC= open circuit; MSCV= maximum specified charging voltage; MSCC= maximum specified charging current; HSCT= highest specified charging temperature; LSCT= lowest specified charging temperature					

Q.1	TABLE: Circuits intended for interconnection with building wiring (LPS)							P
Output Circuit	Condition	U _{oc} (V)	Time (s)	I _{sc} (A)		S (VA)		
				Meas.	Limit	Meas.	Limit	
VGA (RT1 Sc)	Normal	4,98	5	0,95	8	2,87	100	
USB 2.0	Normal	5,17	5	2,81	8	12,33	100	
USB2.0 (PT3 Sc)	Single fault	5,17	5	4,14	8	16,39	100	
USB3.0 port-01	Normal	5,17	5	6,15	8	23,40	100	
USB3.0 port-02	Normal	5,17	5	6,16	8	23,88	100	
USB3.0 (PT1 Sc)	Single fault	5,17	5	7,96	8	27,13	100	
RJ45 port	Normal	0	5	0	8	0	100	
LAN	Normal	0	5	0	8	0	100	
SAS	Normal	0	5	0	8	0	100	
VGA port	Normal	4,99	5	0,93	8	2,83	100	
RS232 port	Normal	5,58	5	0	8	0	100	
Supplementary Information:								
Sc=Short circuit.								

T.2, T.3, T.4, T.5	TABLE: Steady force test						P
Part/Location	Material	Thickness (mm)	Probe	Force (N)	Test Duration (s)	Observation	
Top side near PSU	Metal	0,8	--	250	5	No damage, no cracking.	
Left side near PSU	Metal	0,8	--	250	5	No damage, no cracking.	
Bottom side near PSU	Metal	0,8	--	250	5	No damage, no cracking.	
Supplementary information:							

T.6, T.9	TABLE: Impact test				P
Location/part	Material	Thickness (mm)	Height (mm)	Observation	

IEC 62368-1			
Clause	Requirement + Test	Result - Remark	Verdict

Top side near PSU	Metal	0,8	1300	No damage, no cracking.
Left side near PSU	Metal	0,8	1300	No damage, no cracking.
Bottom side near PSU	Metal	0,8	1300	No damage, no cracking.
Supplementary information:				

T.7	TABLE: Drop test				N/A
Location/part	Material	Thickness (mm)	Height (mm)	Observation	
--	--	--	--	--	
Supplementary information:					

T.8	TABLE: Stress relief test					N/A
Location/Part	Material	Thickness (mm)	Oven Temperature (°C)	Duration (h)	Observation	
--	--	--	--	--	--	
Supplementary information:						

X	TABLE: Alternative method for determining minimum clearances distances			N/A
Clearance distanced between:	Peak of working voltage (V)	Required cl (mm)	Measured cl (mm)	
--	--	--	--	
Supplementary information:				

IEC 62368-1			
Clause	Requirement + Test	Result - Remark	Verdict

4.1.2	TABLE: List of critical components					P
Object / part No.	Manufacturer/ trademark	Type / model	Technical data	Standard	Mark(s) of conformity ¹	
Metal enclosure	Interchangeable	Interchangeable	Min. 0,8 mm thickness	IEC 62368-1: 2018 and EN IEC 62368-1:2020+A11:2020 and AS/NZS 62368.1:2022	Tested with appliance	
Left and right ears (Plastic parts, outside of fire enclosure)	Interchangeable	Interchangeable	Minimum HB	UL 94, UL 746C	UL	
Building-in power supply (Max two provided)	China Greatwall Technology Group Co., Ltd	GW-CRPS550N	Input: 100-240V~, 7-3,5A; 60/50Hz 240 Vd.c.; 3,5A; Output: +12Vdc, 45A; +12VSB, 3A; 550W Max; Altitude: 5000m	IEC 62368-1:2014	UL CB Ref. Certif. No.: DK-97775-UL; CB report No.: ESTSP2004 0109	
HDD (Alternative)	Interchangeable	Interchangeable	12Vdc, 0,99A, 5Vdc, 0,85A maximum.	IEC 62368-1: 2018 and EN IEC 62368-1:2020+A11:2020 and AS/NZS 62368.1:2022	Tested with appliance	
Printed Wiring Board (PWB)	Interchangeable	Interchangeable	Min. V-1, 105°C	UL796 UL94	UL	
RTC battery	GUANGZHOU TIANQIU ENTERPRISE CO LTD	CR2032	Max Abnormal Charging Current 10mA; Max Abnormal Charging Voltage 3,5 V d.c.	UL1642	UL MH48705	
System Fan (There are three identical system fans in the device)	Asia Vital Components Co., Ltd.	DBPJ1238B2FP 007	12Vdc, 2,0A Min. 179,22 CFM.	UL 507 EN 62368-1:2014/A11:2017	UL E158191 TUV SUD No. B 025730 0887	
DC Fan on main board	DELTA ELECTRONICS INC	AFB0612EHD	12V,0,48A, Min 34,5 CFM	UL 507 DIN EN IEC 62368-1 (VDE 0868-1):2021-05; EN IEC 62368-1:2020+A11:202	UL E132003 VDE 40012706	

IEC 62368-1			
Clause	Requirement + Test	Result - Remark	Verdict

Supplementary information:

¹⁾ Provided evidence ensures the agreed level of compliance. See OD-CB2039.

---End of Report---

Details of: General View

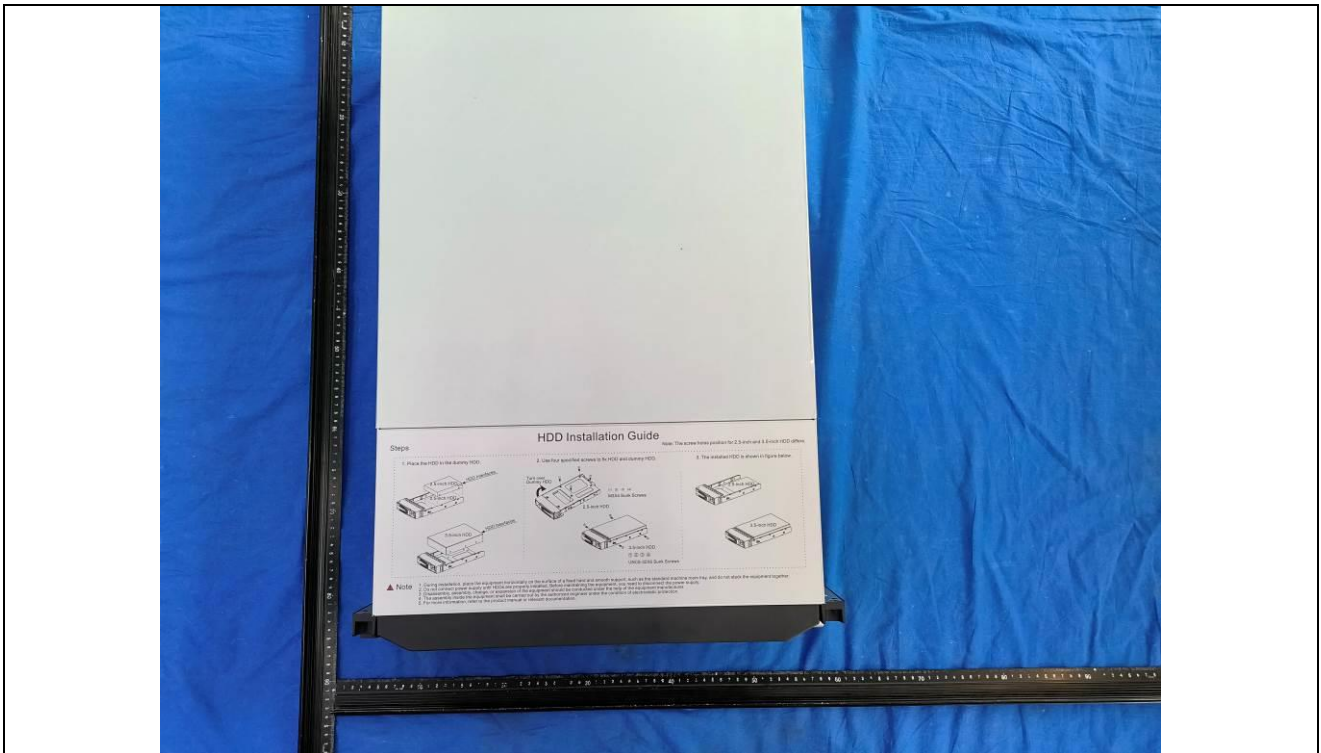

Details of: General View



Details of: General View



Details of: Terminal View



Details of: General View



Details of: General View



Details of: General View



Details of: Internal View



Details of: Internal View



Details of: Internal View

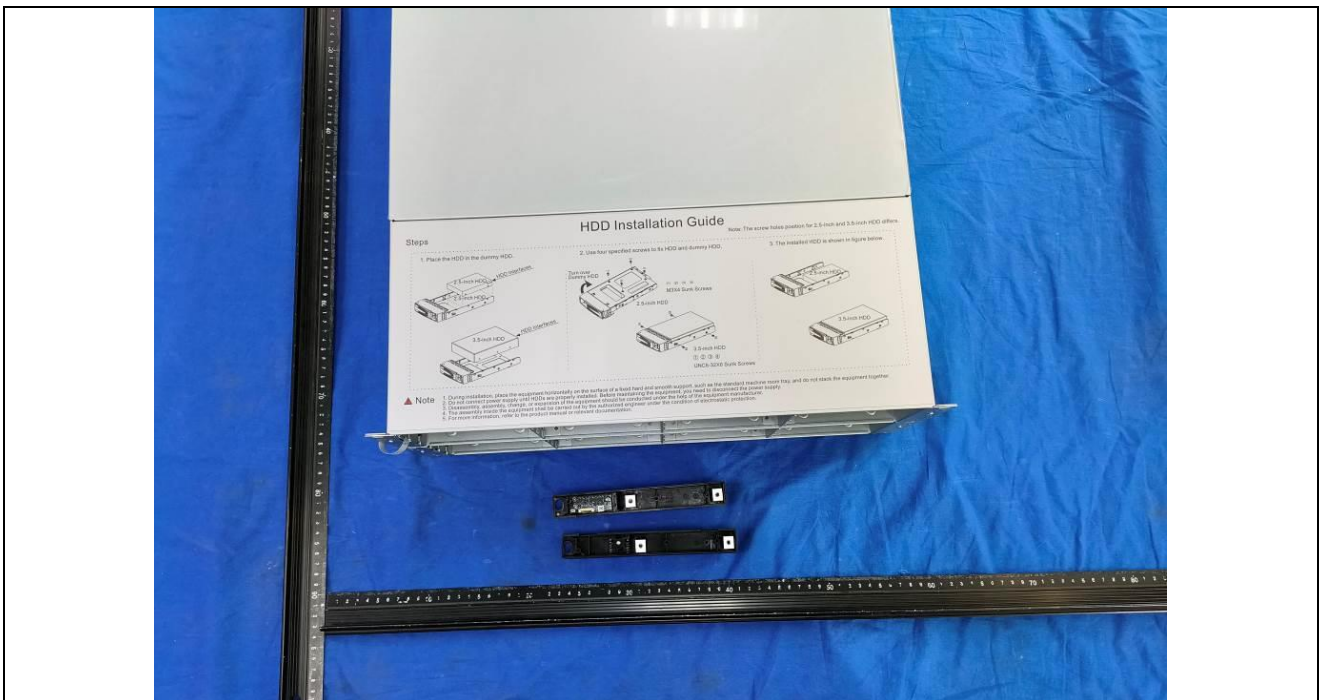

Details of: Internal View



Details of: Internal View

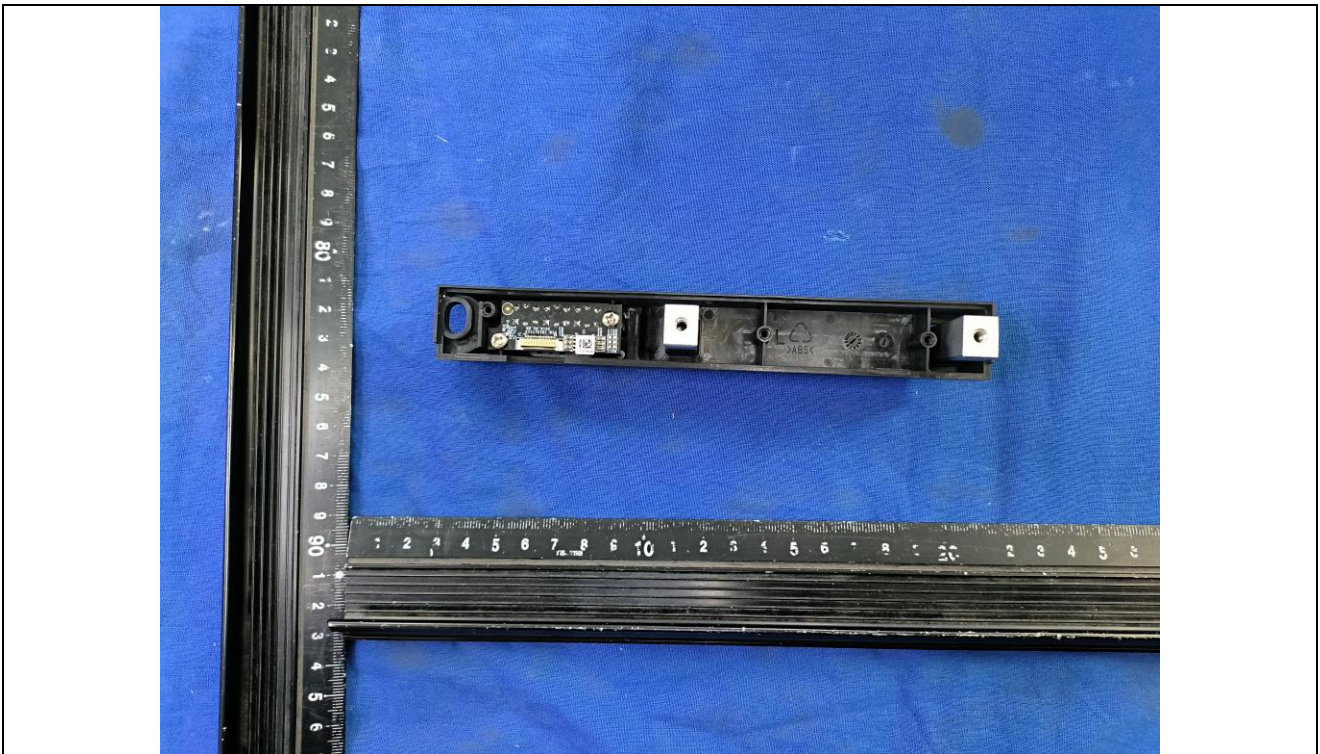

Details of: Internal View

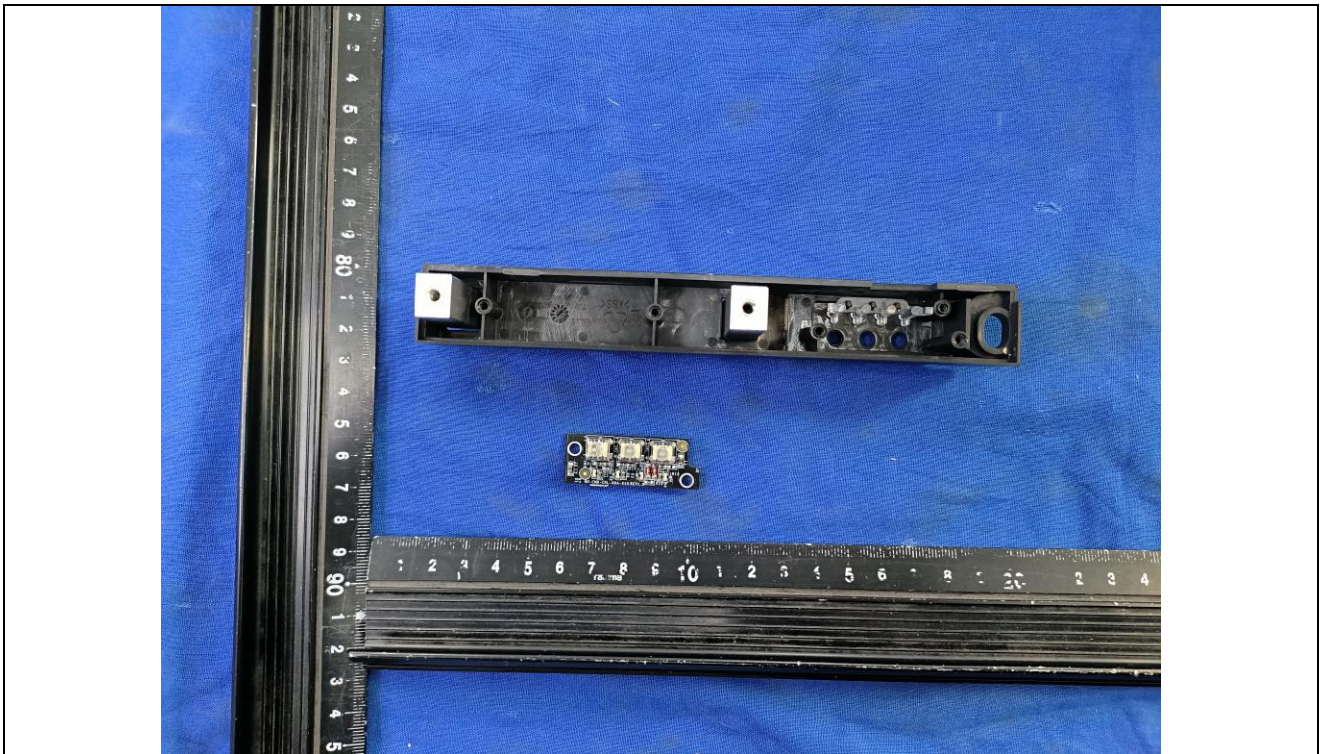

Details of: Internal View

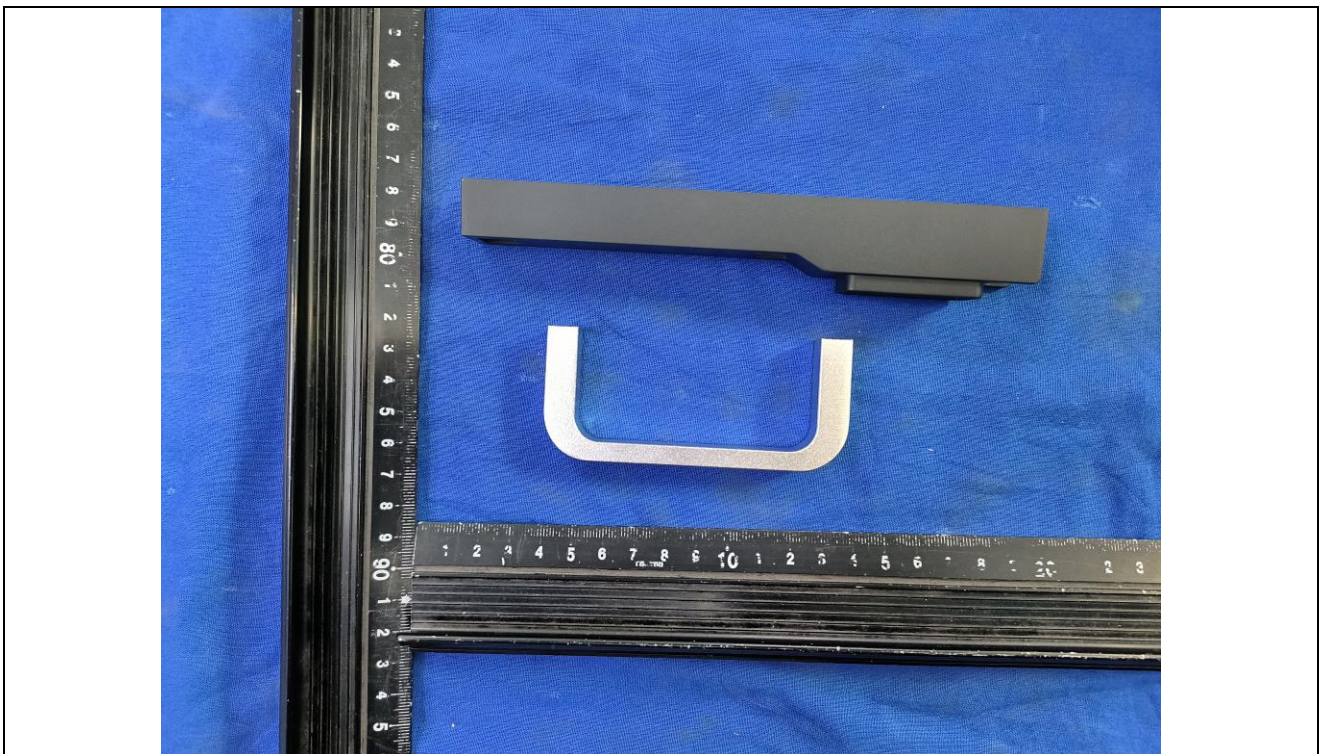

Details of: PCB

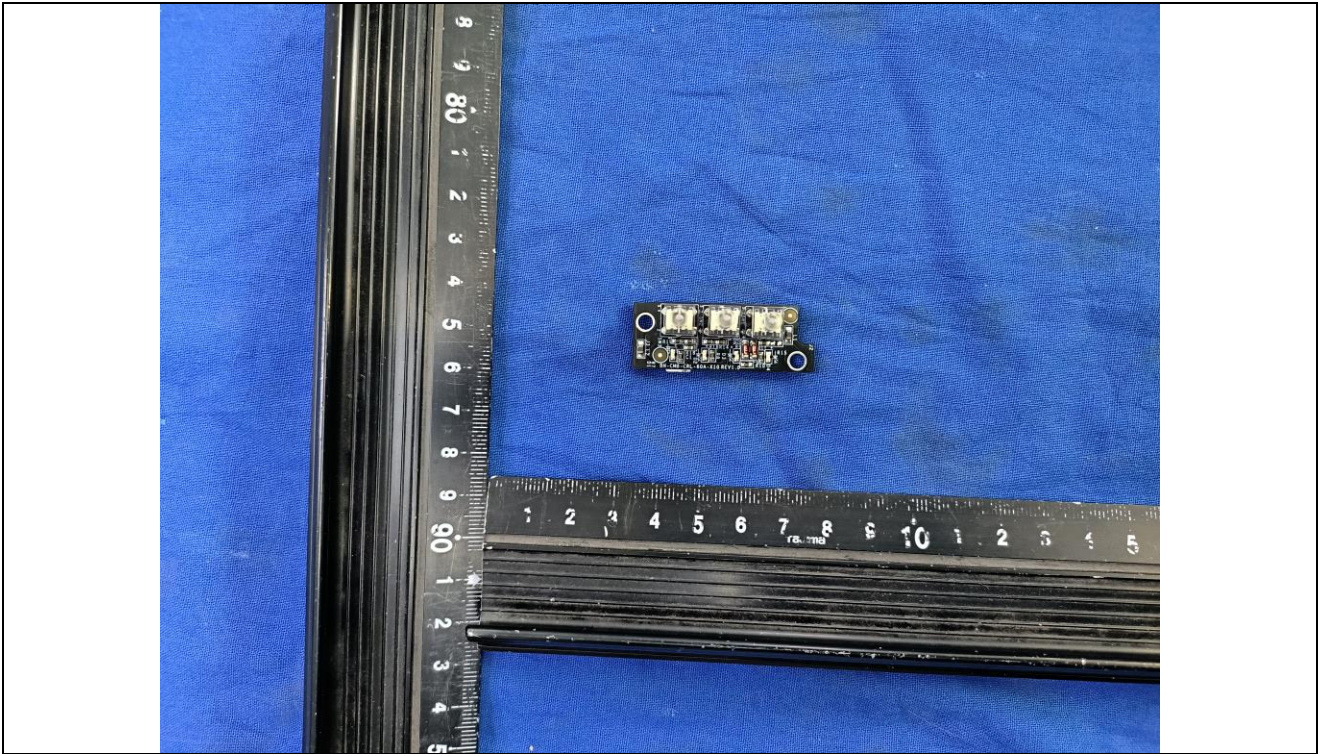

Details of: PCB

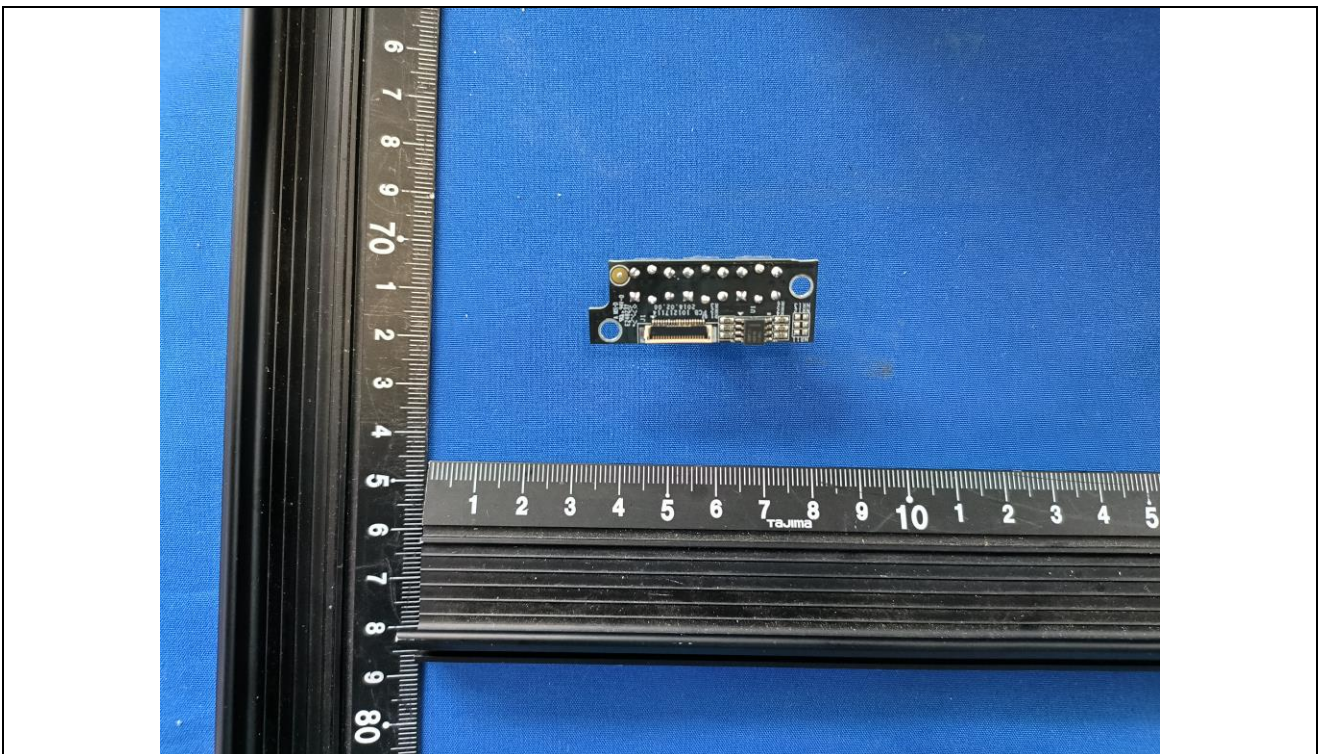

Details of: PCB

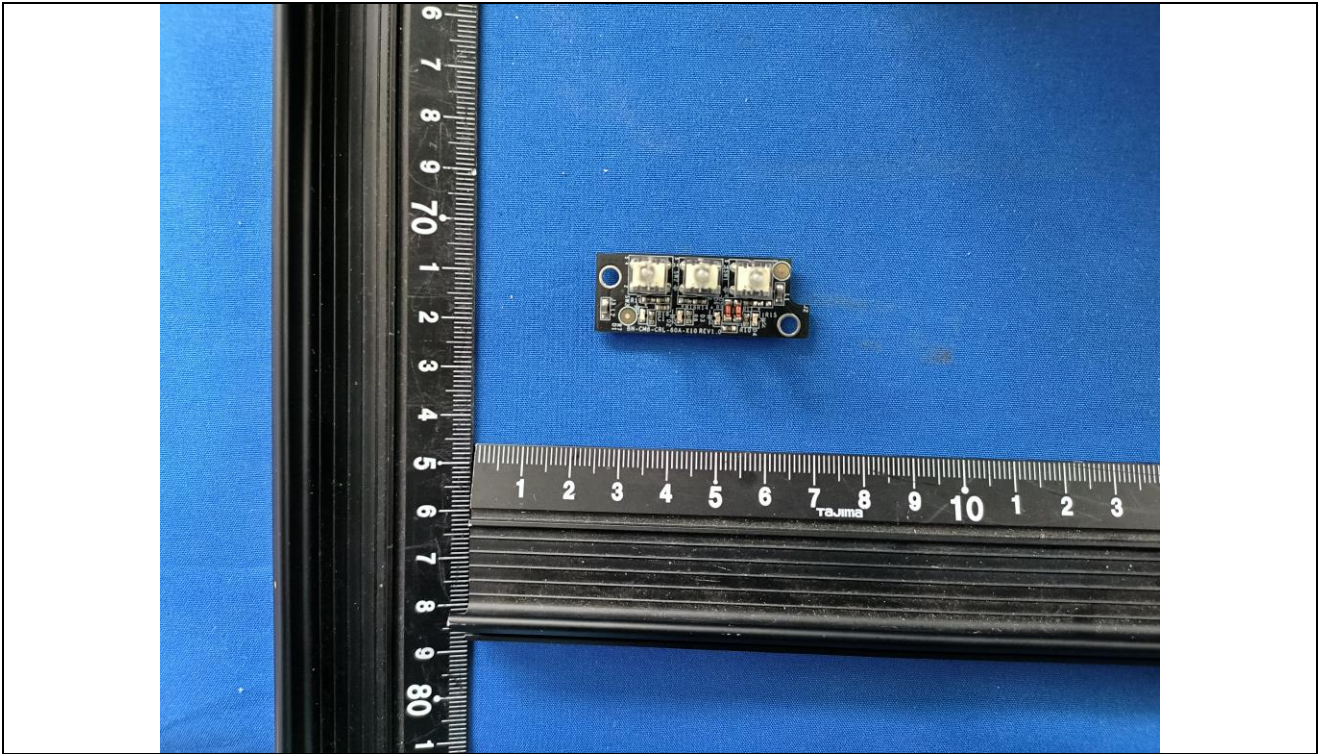

Details of: Internal View



Details of: Internal View



Details of: Internal View



Details of: Internal View



Details of: Internal View



Details of: Internal View



Details of: Internal View

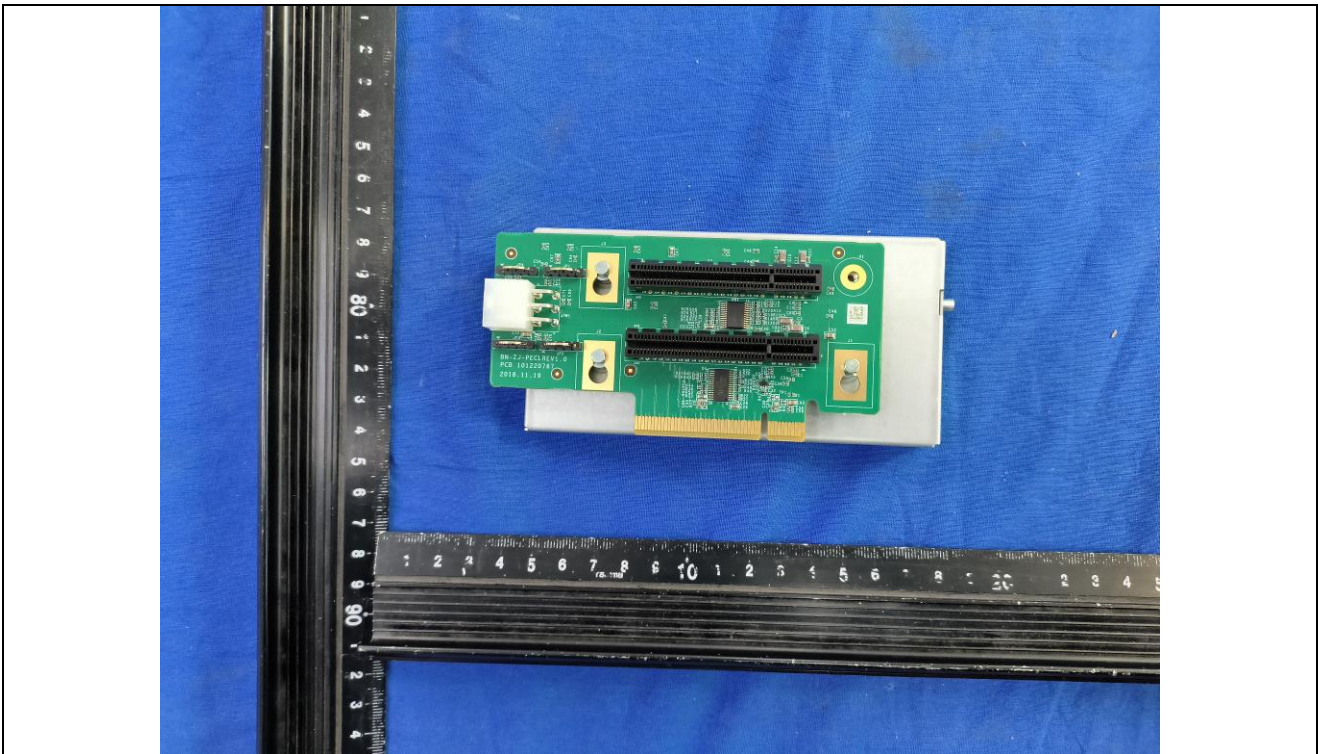

Details of: Internal View

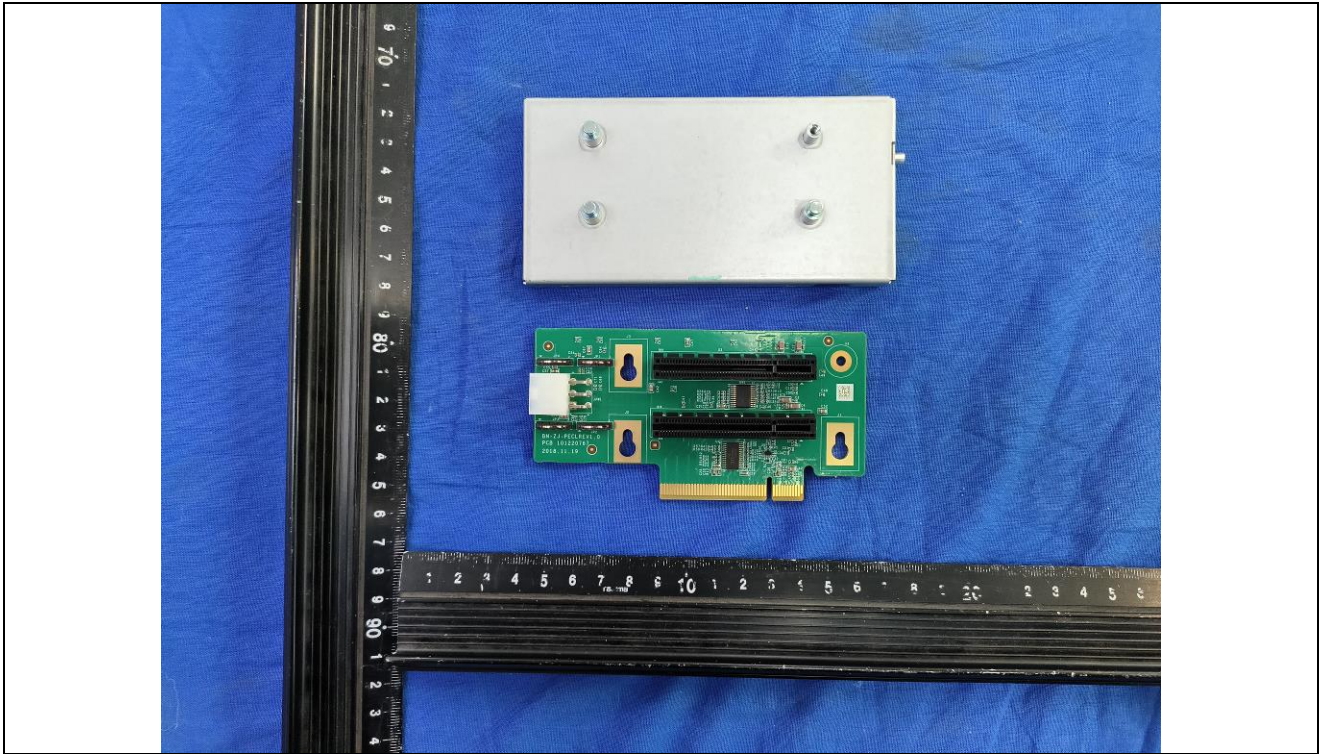

Details of: PCB

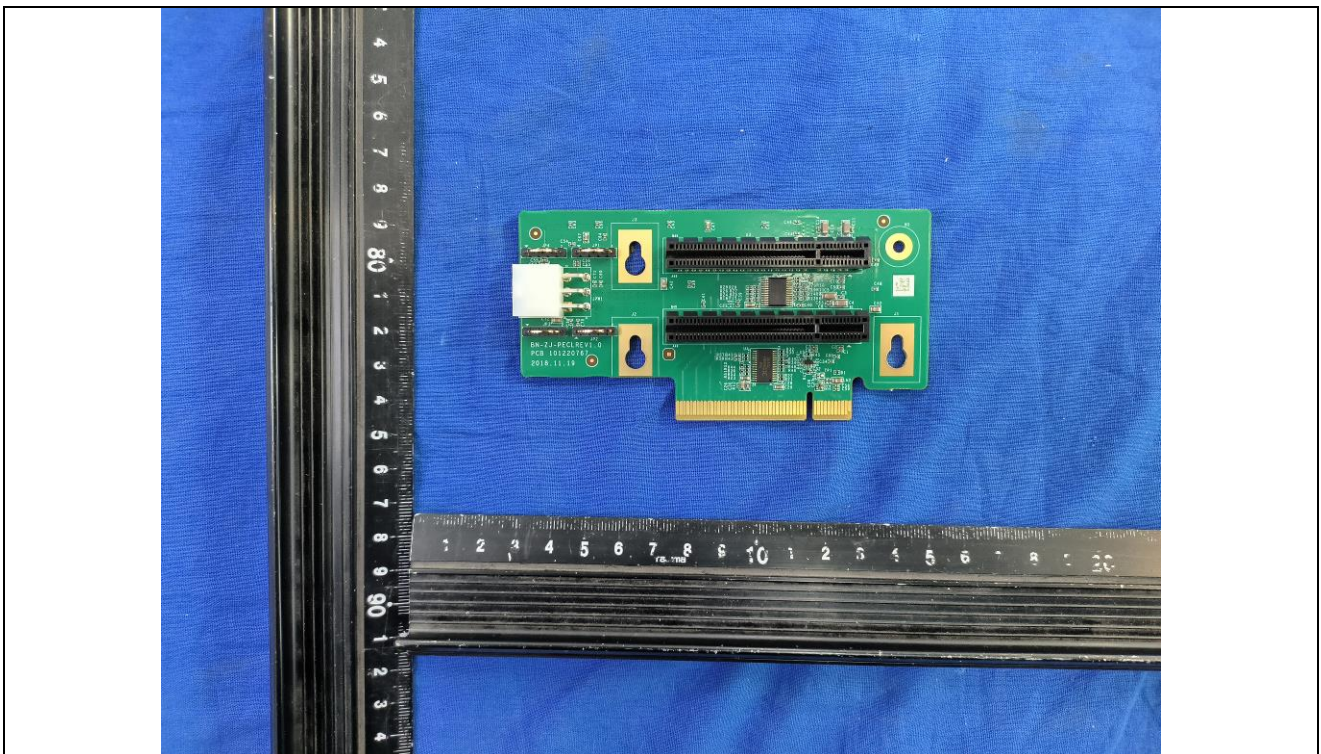

Details of: PCB

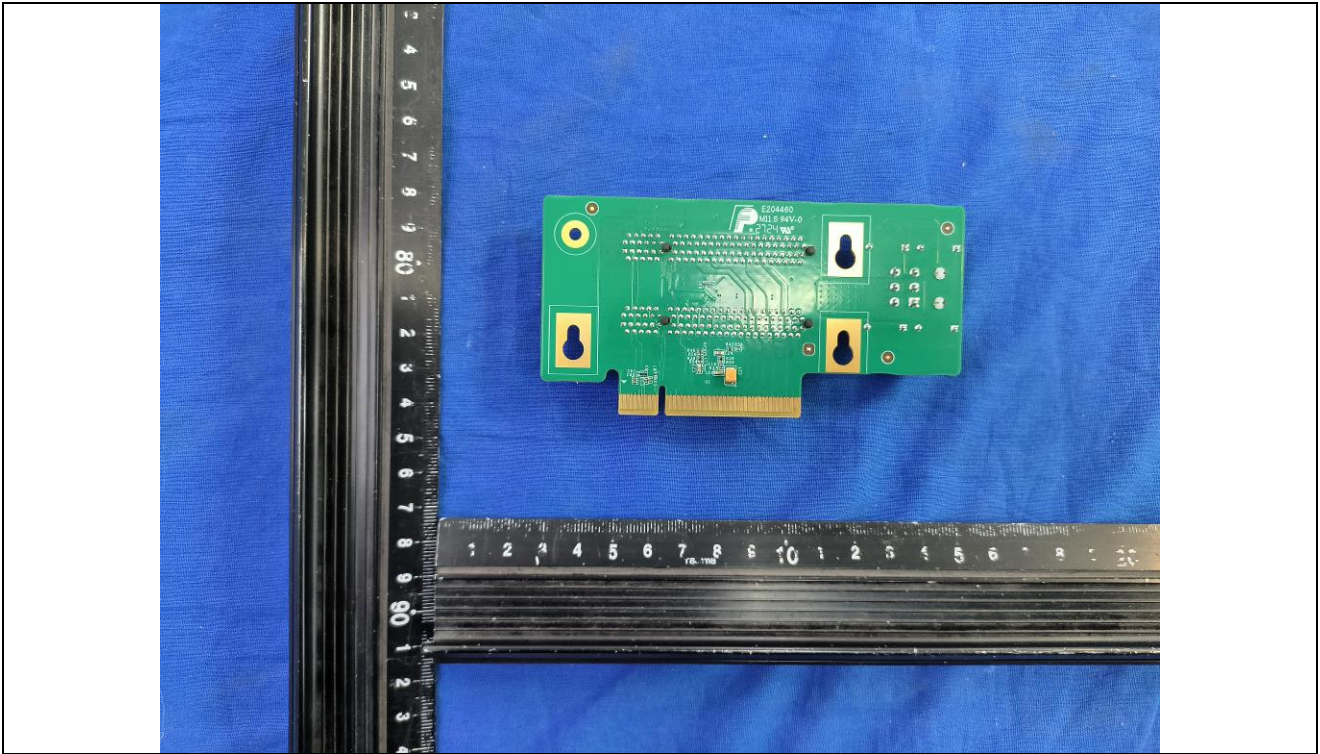

Details of: Internal View

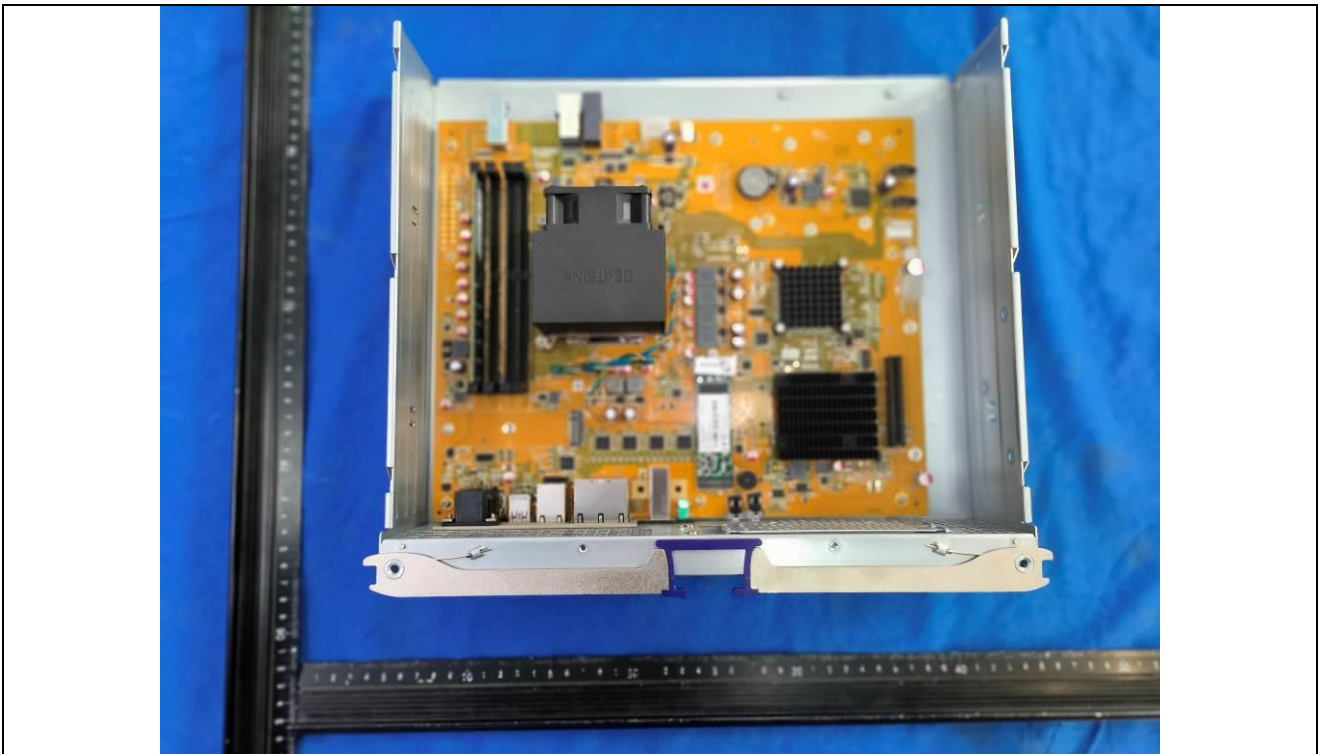

Details of: Internal View



Details of: PCB

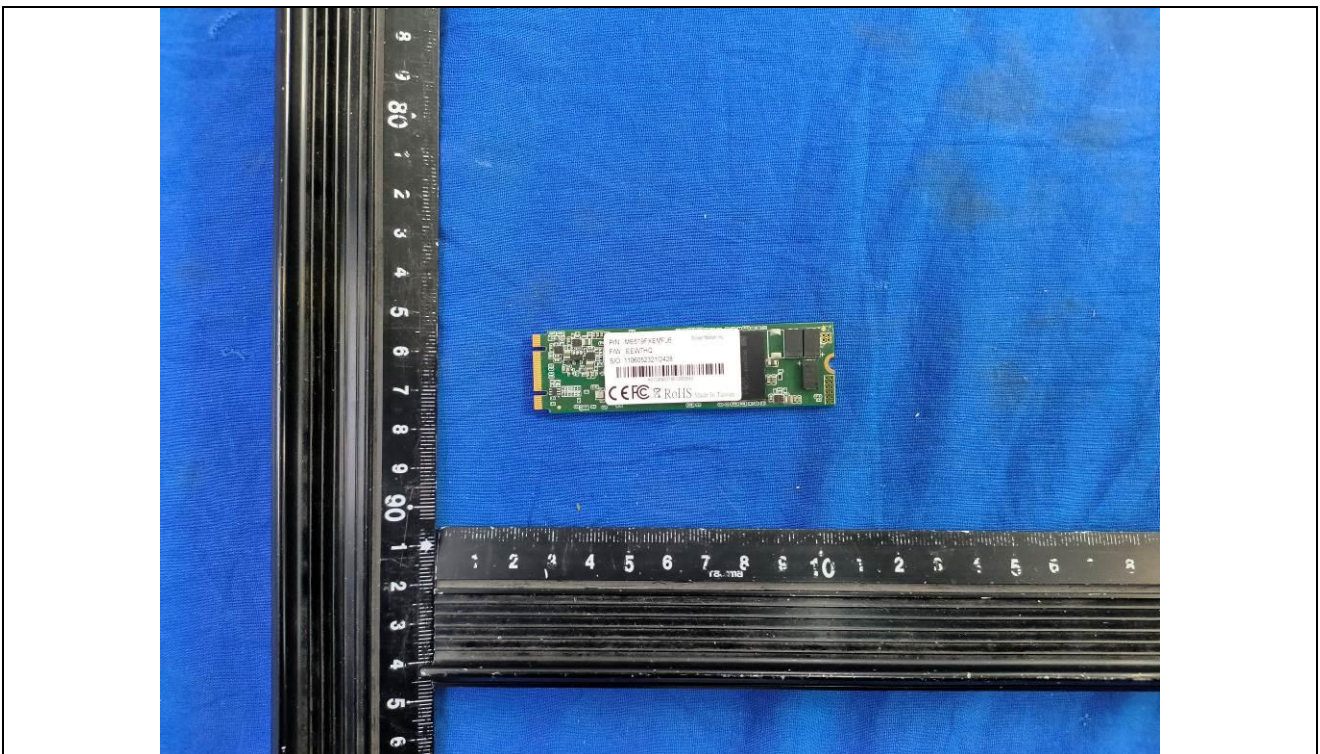

Details of: PCB

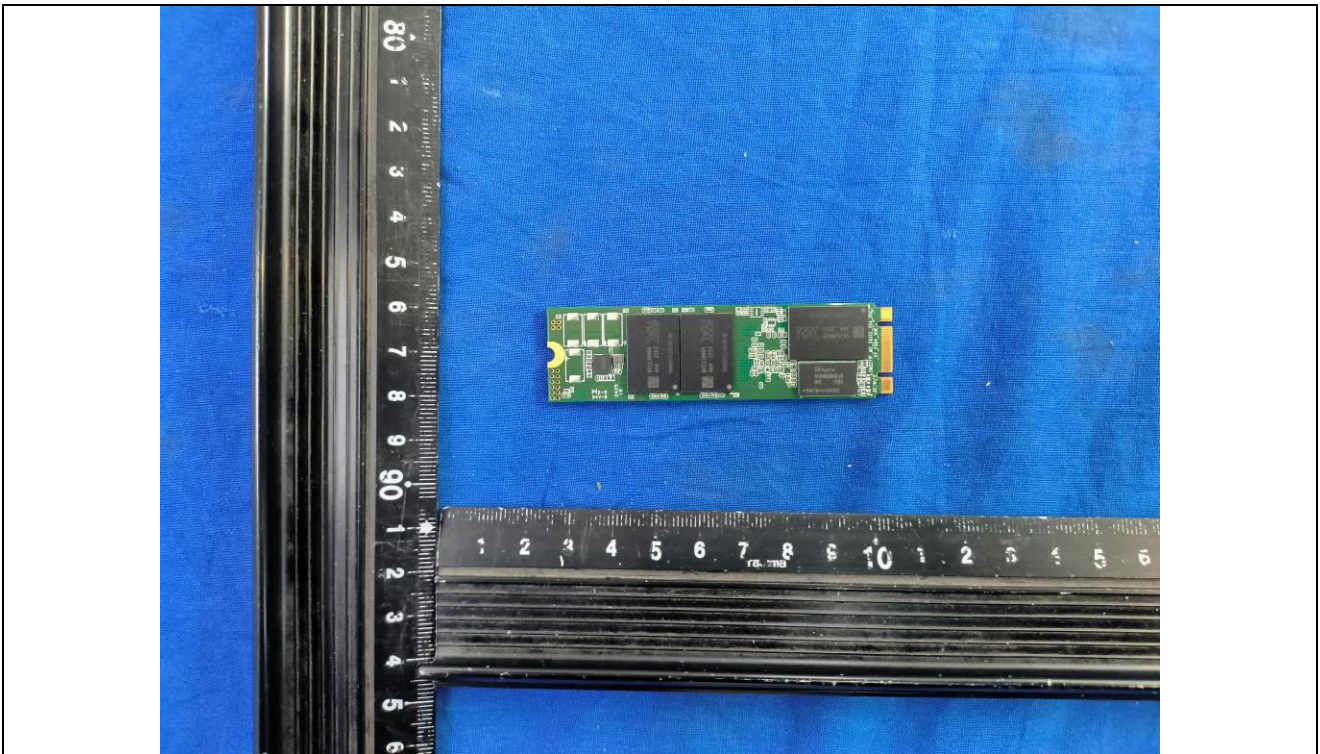

Details of: Internal View



Details of: Internal View



Details of: PCB

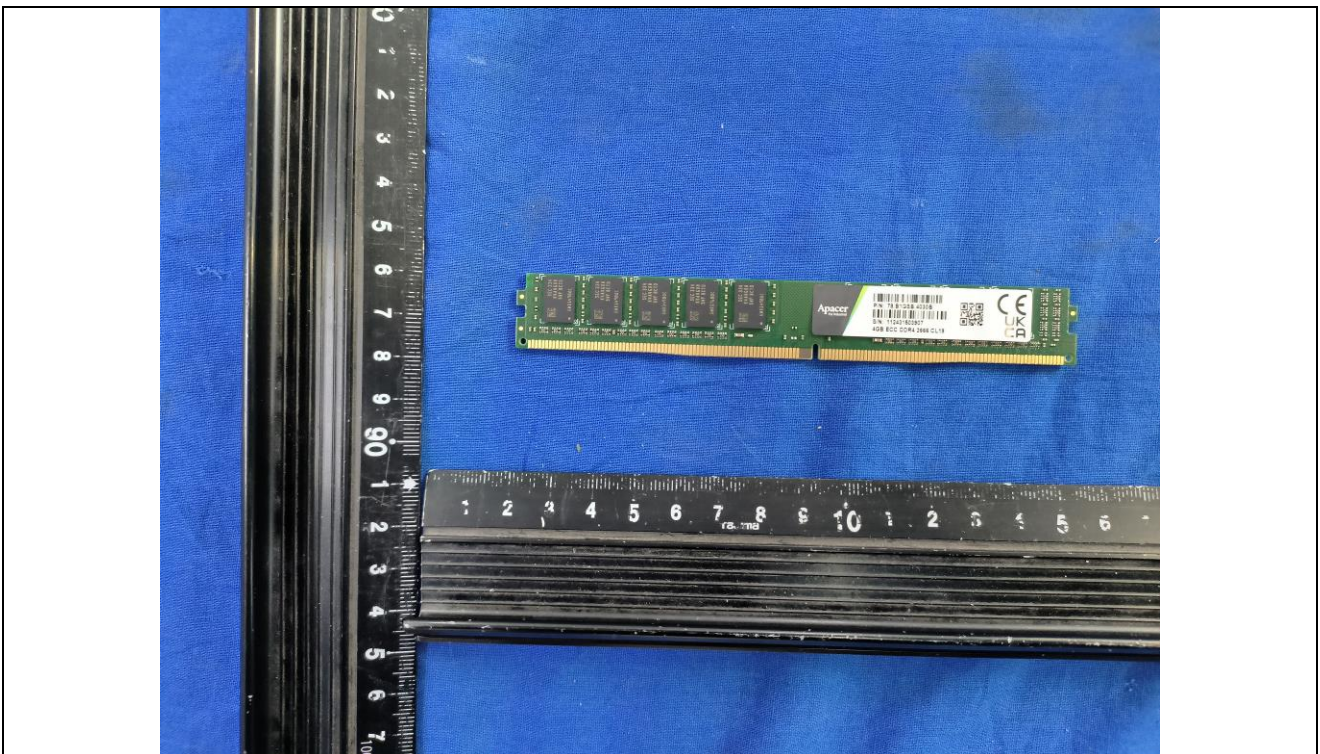

Details of: PCB

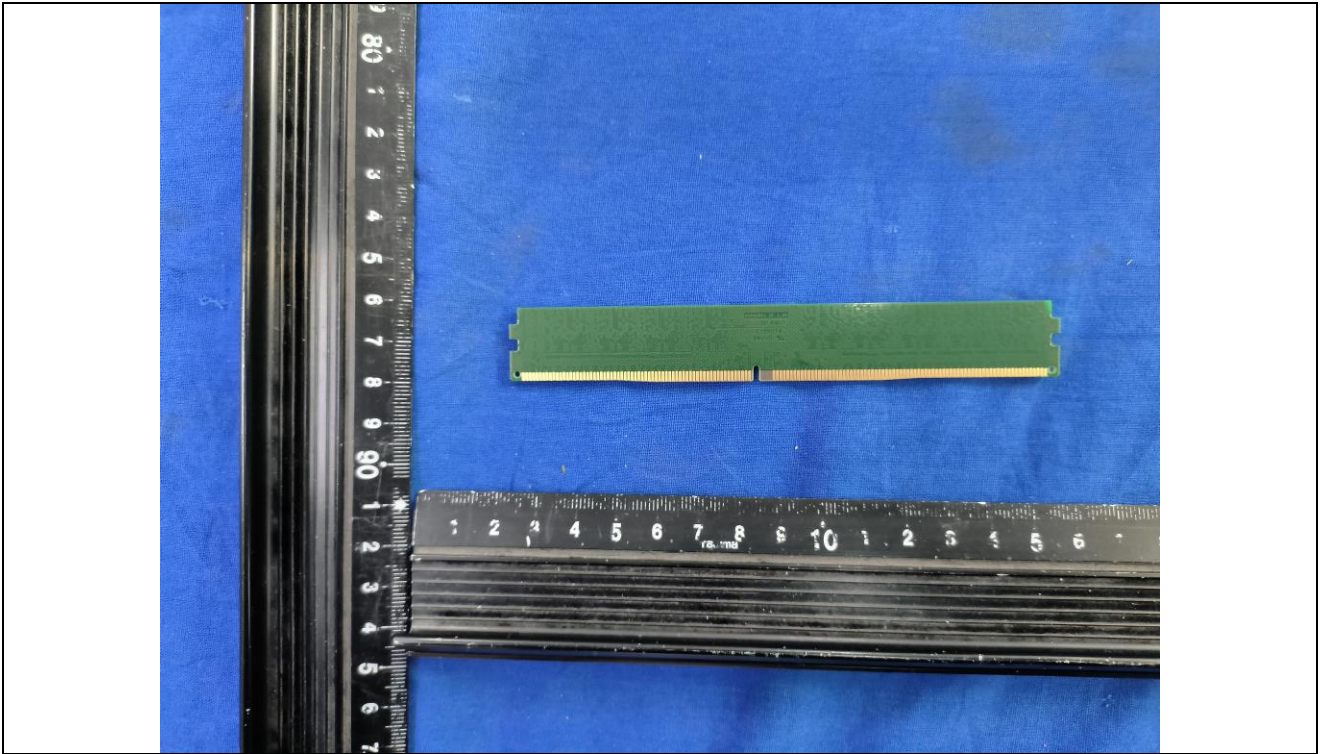

Details of: Internal View

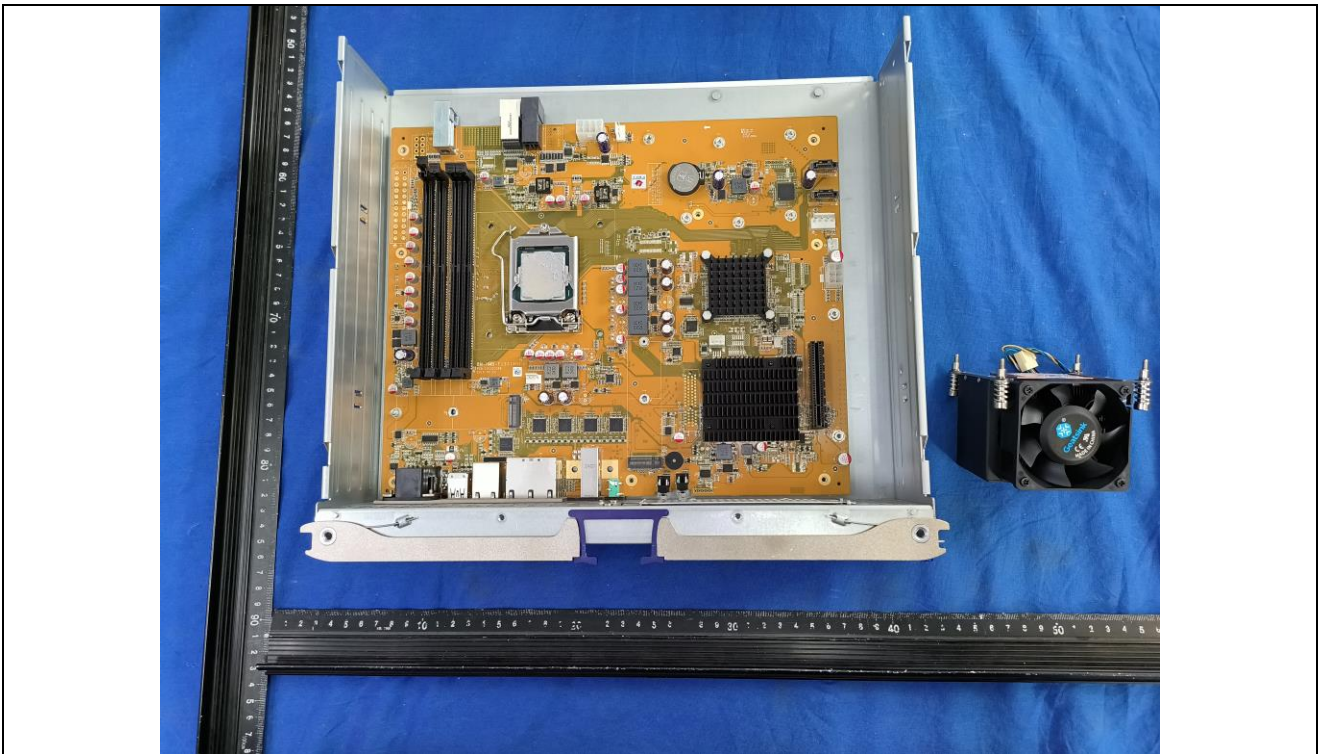

Details of: DC fan

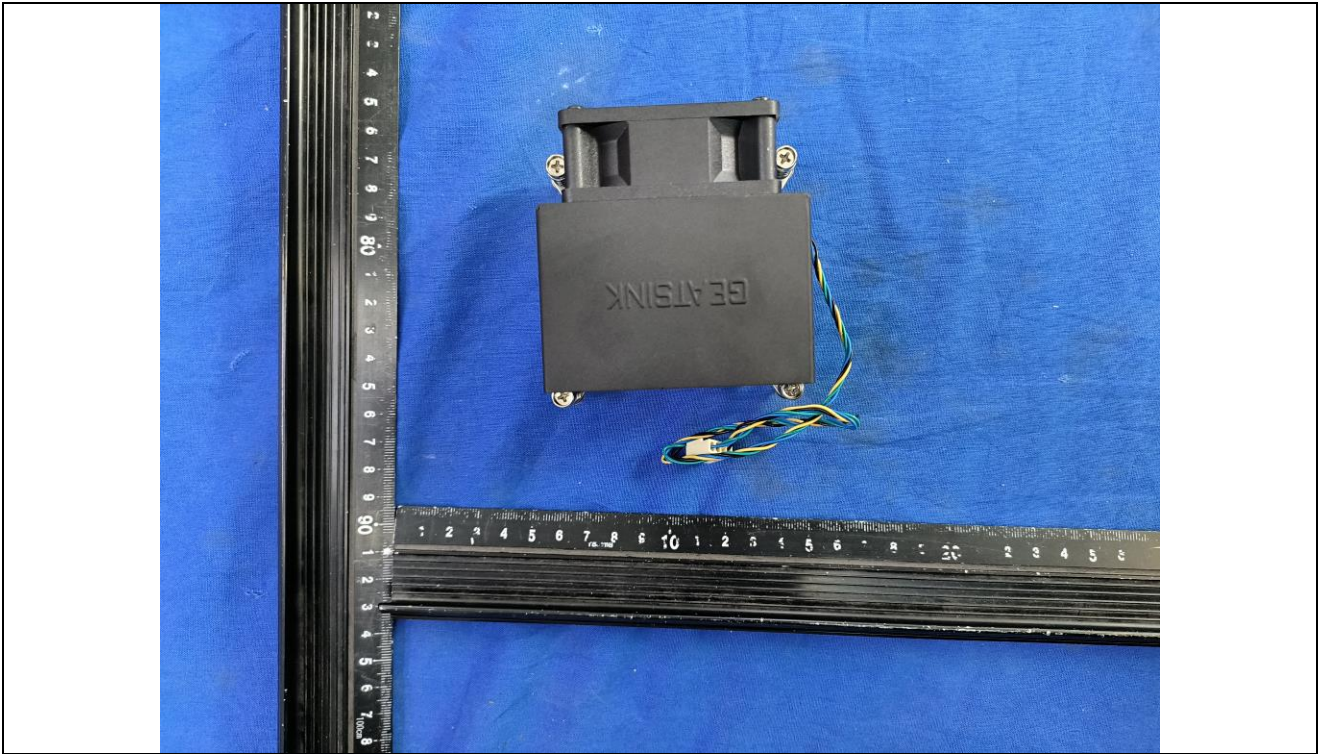

Details of: DC fan

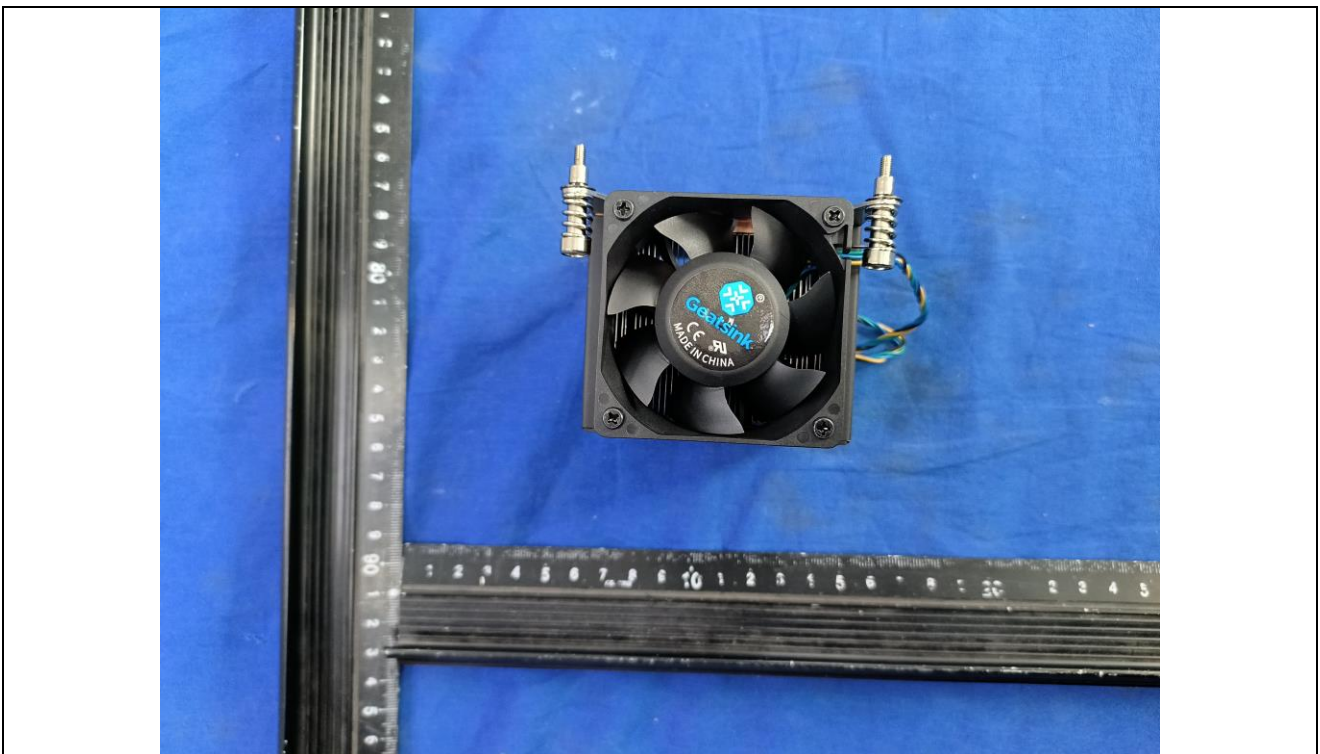

Details of: Internal View

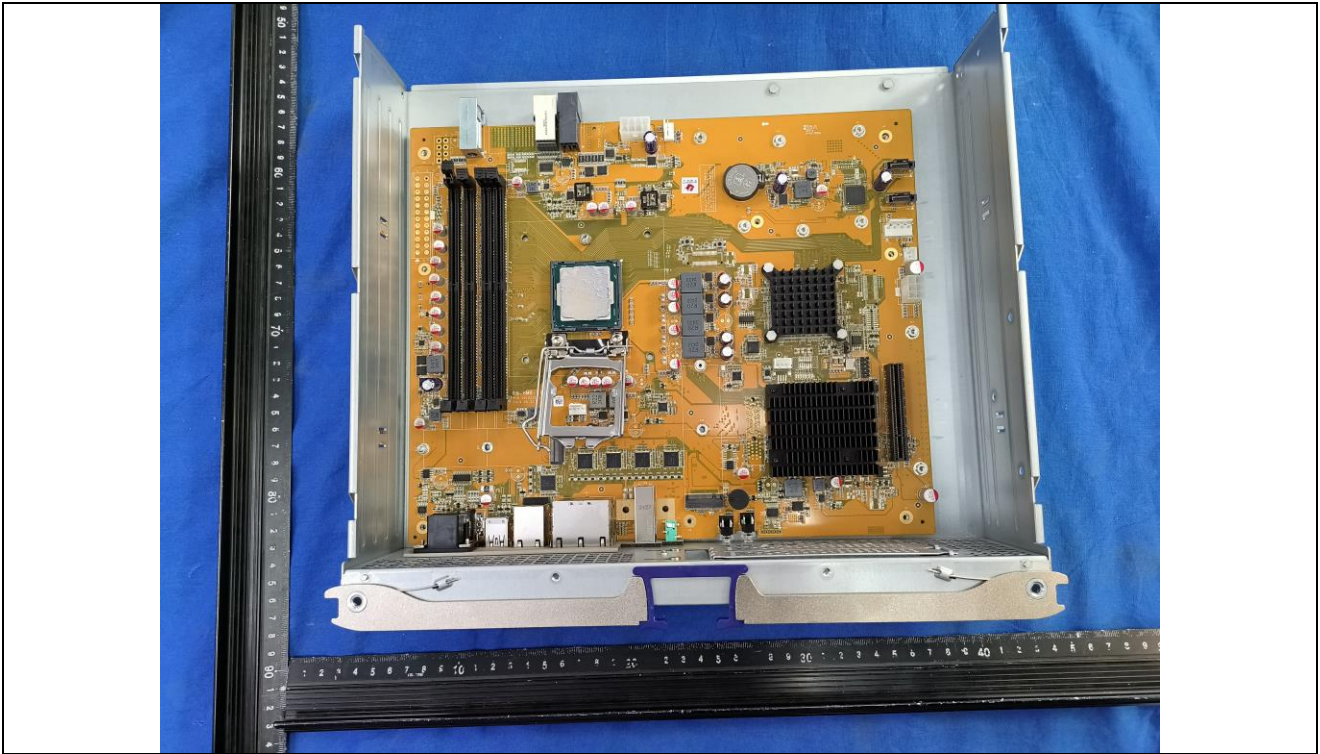

Details of: Internal View

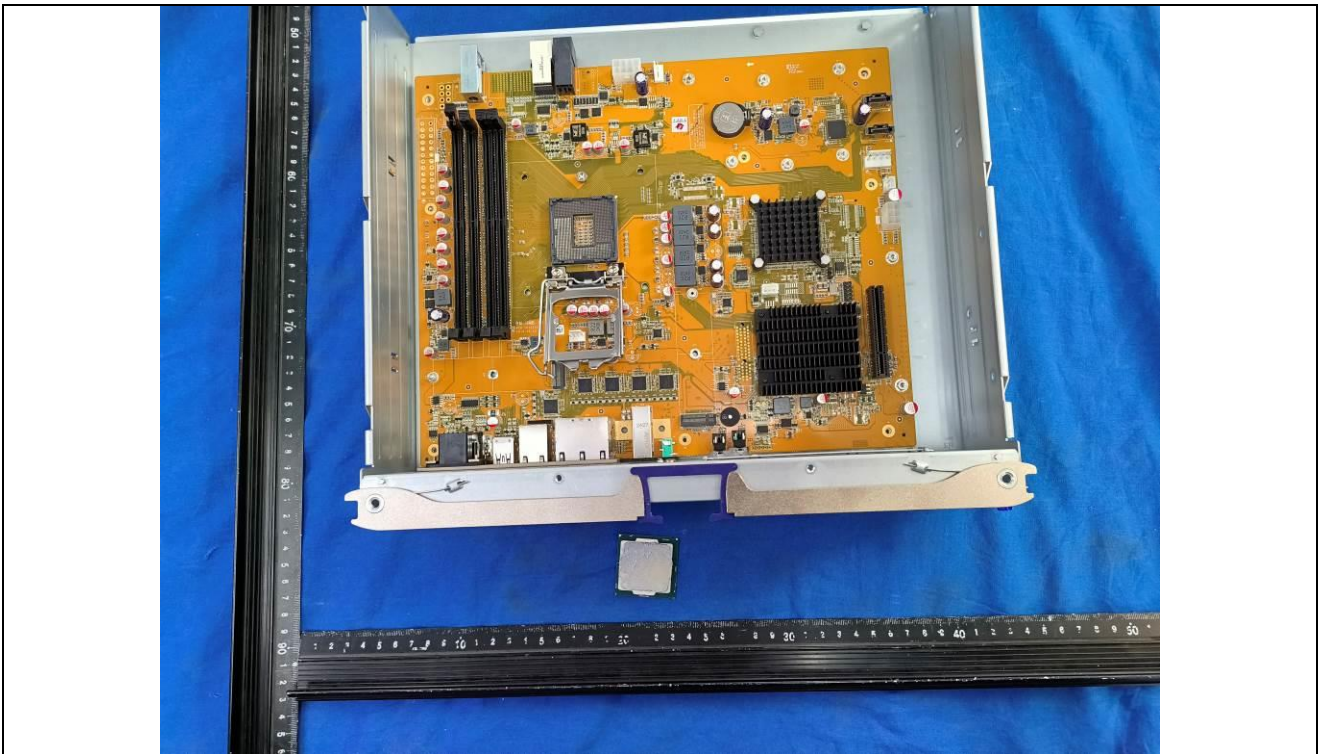

Details of: PCB

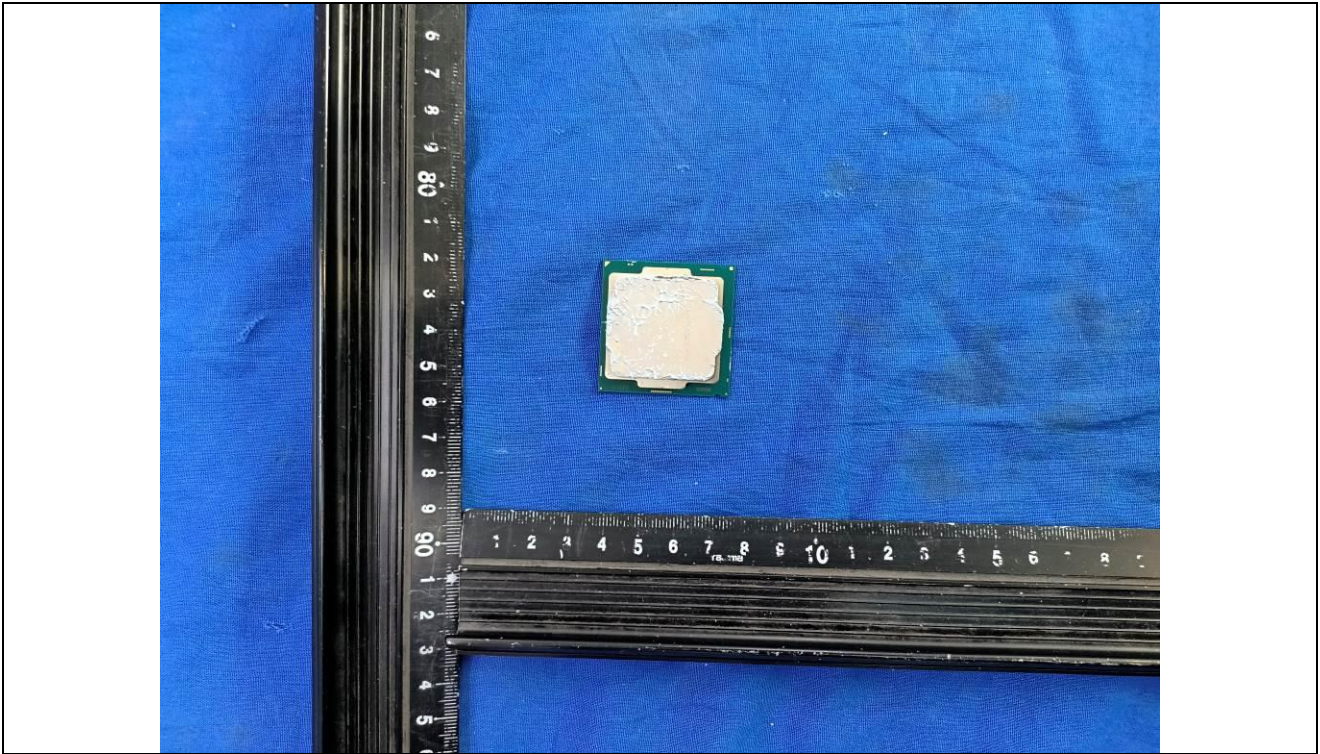

Details of: PCB

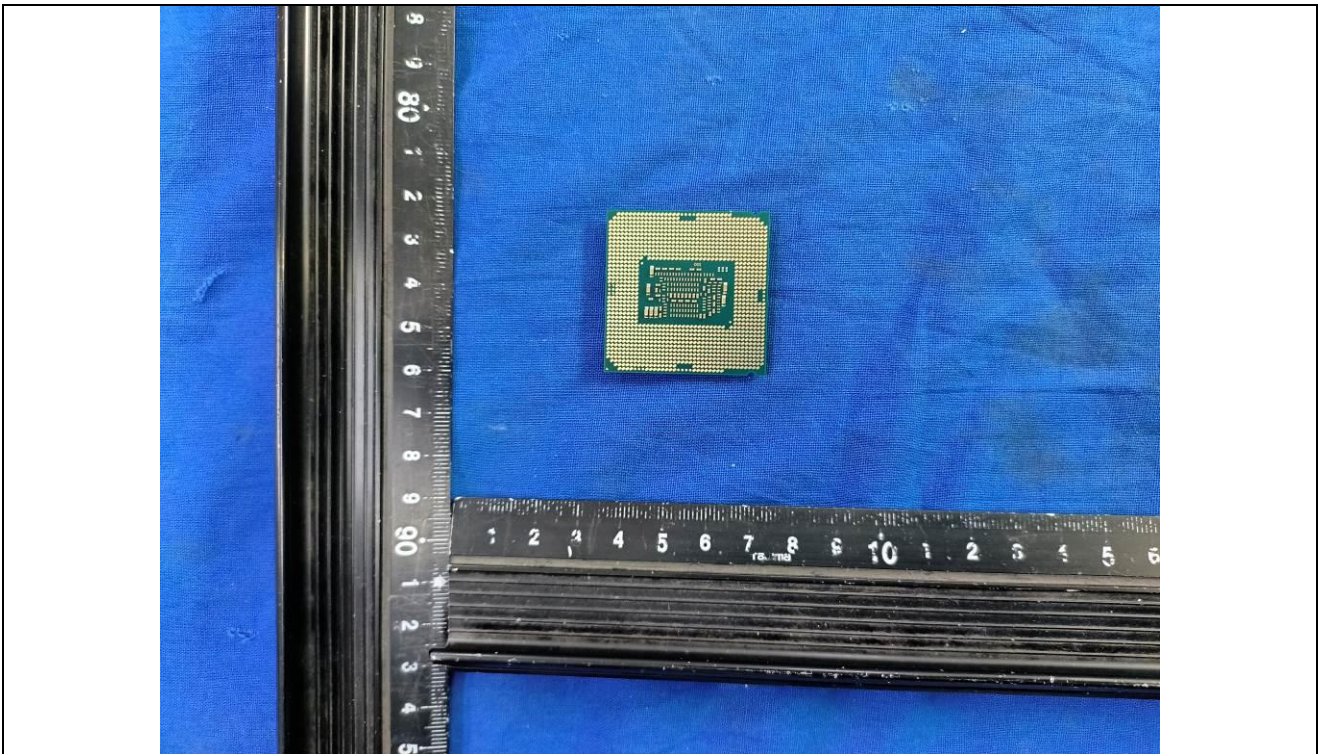

Details of: Internal View

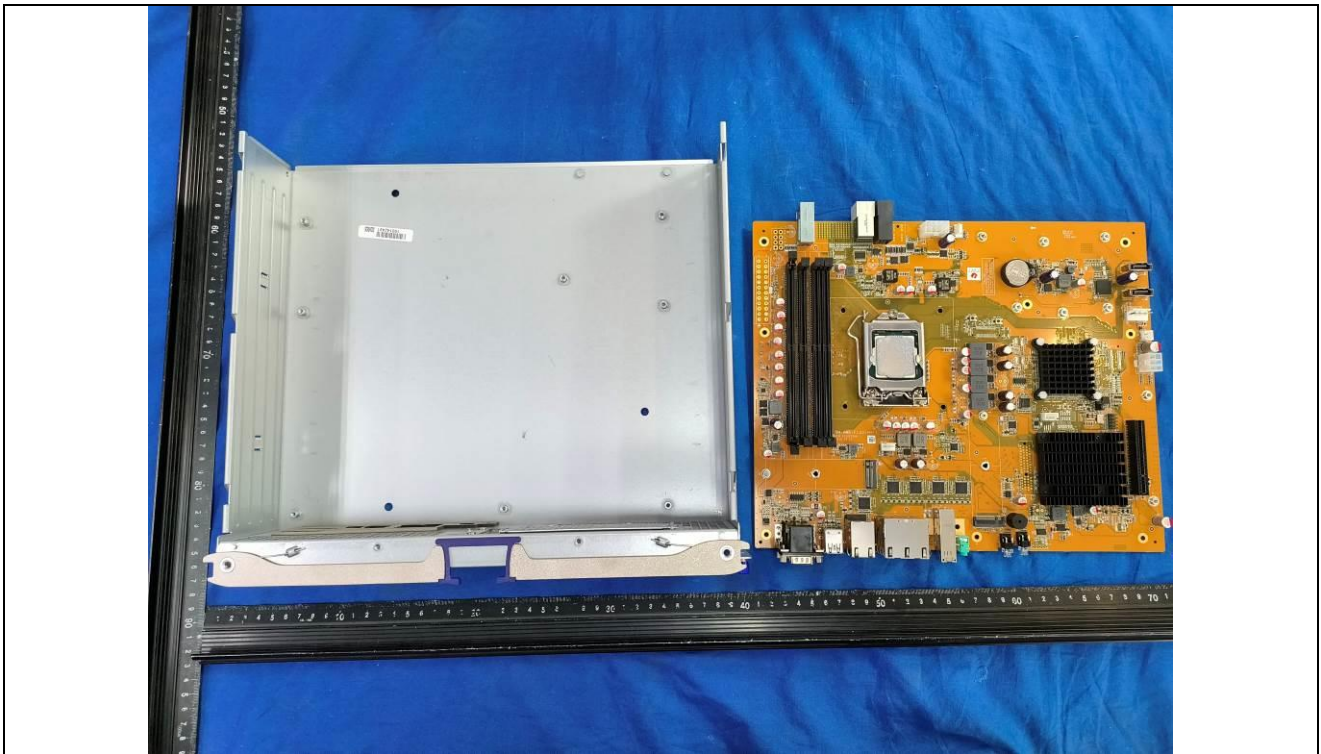

Details of: PCB

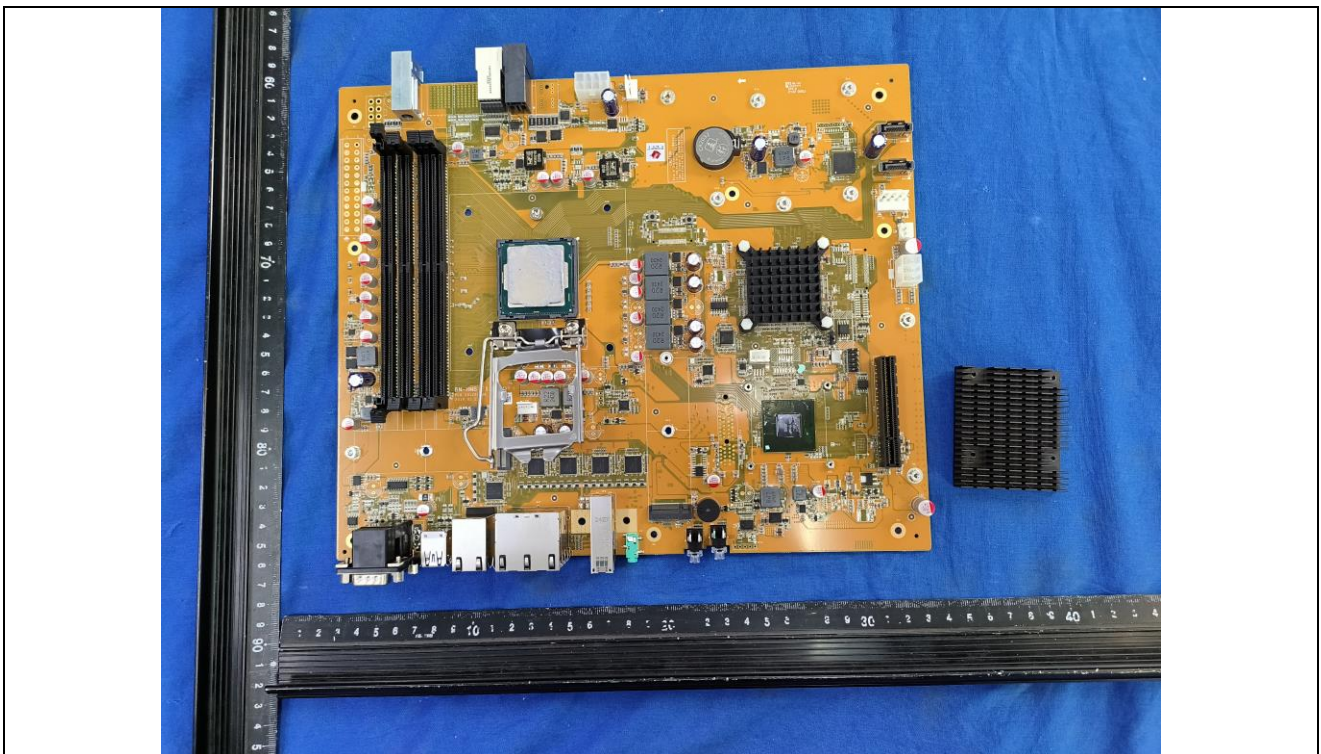

Details of: PCB

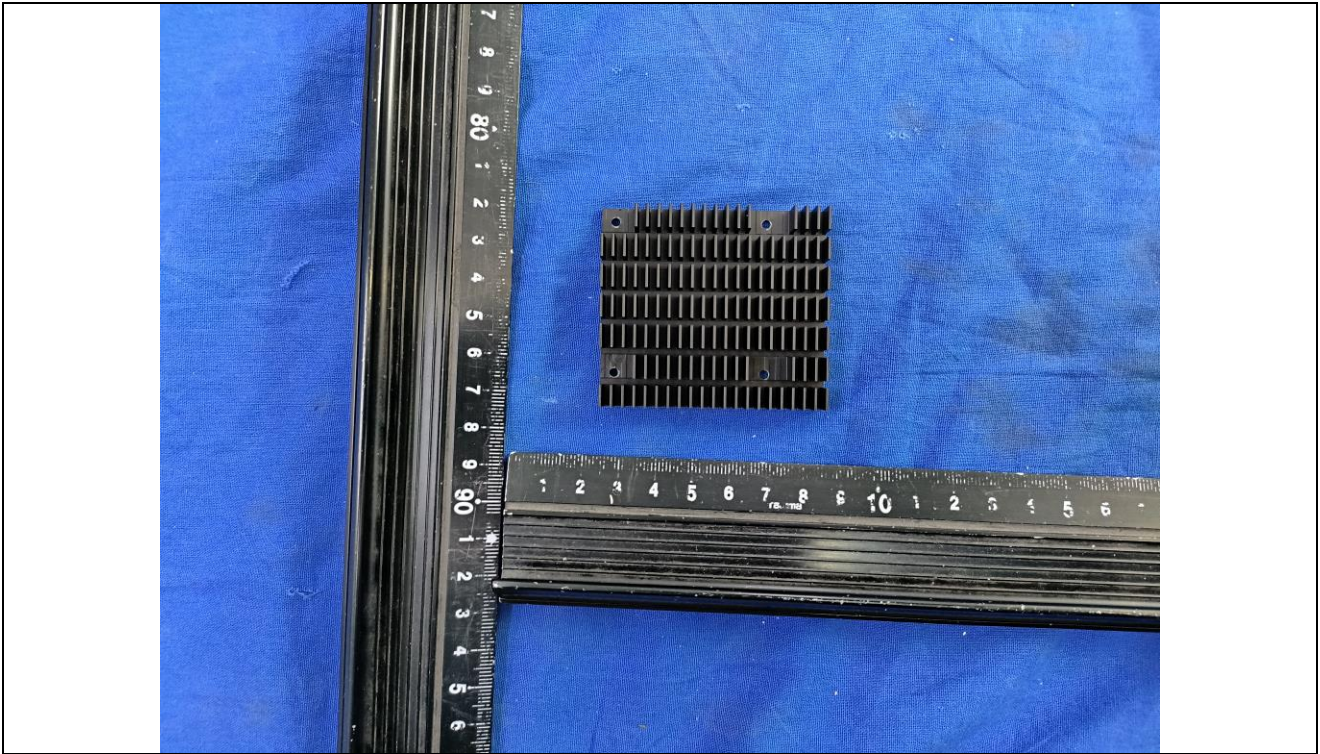

Details of: PCB

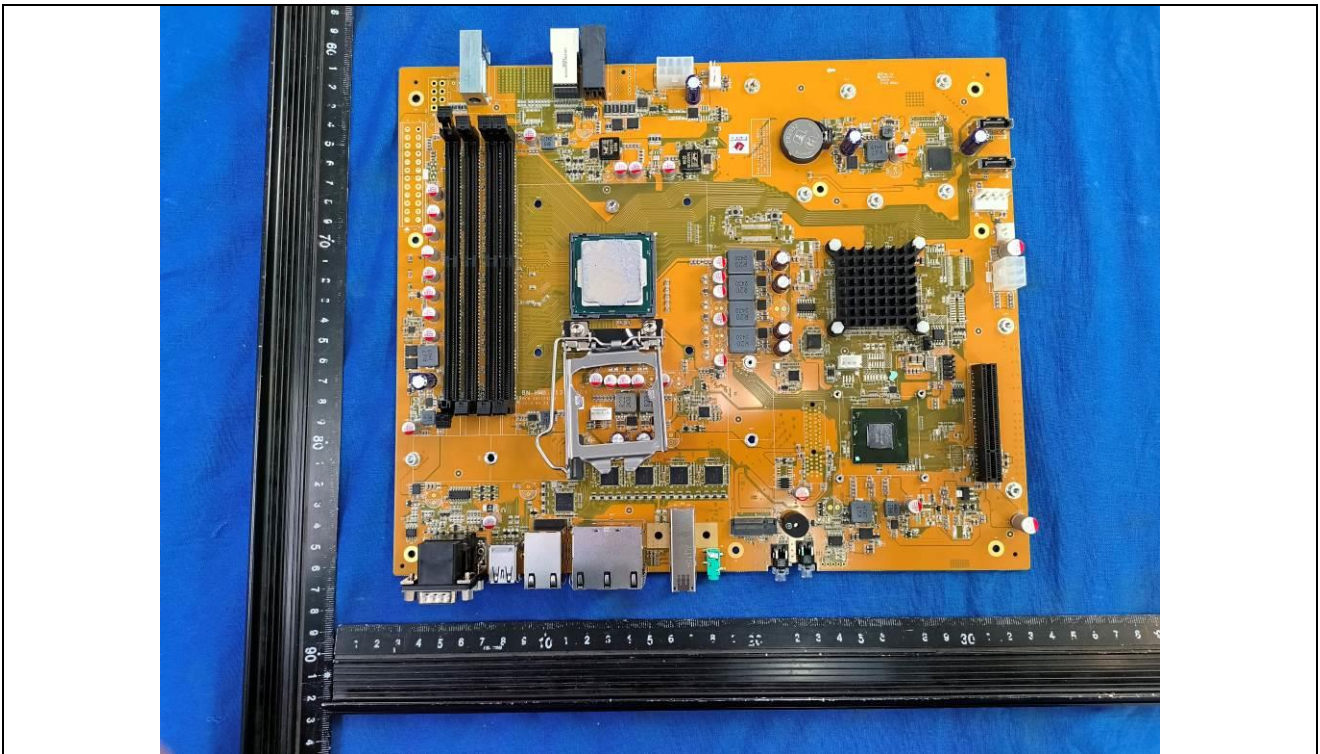

Details of: PCB

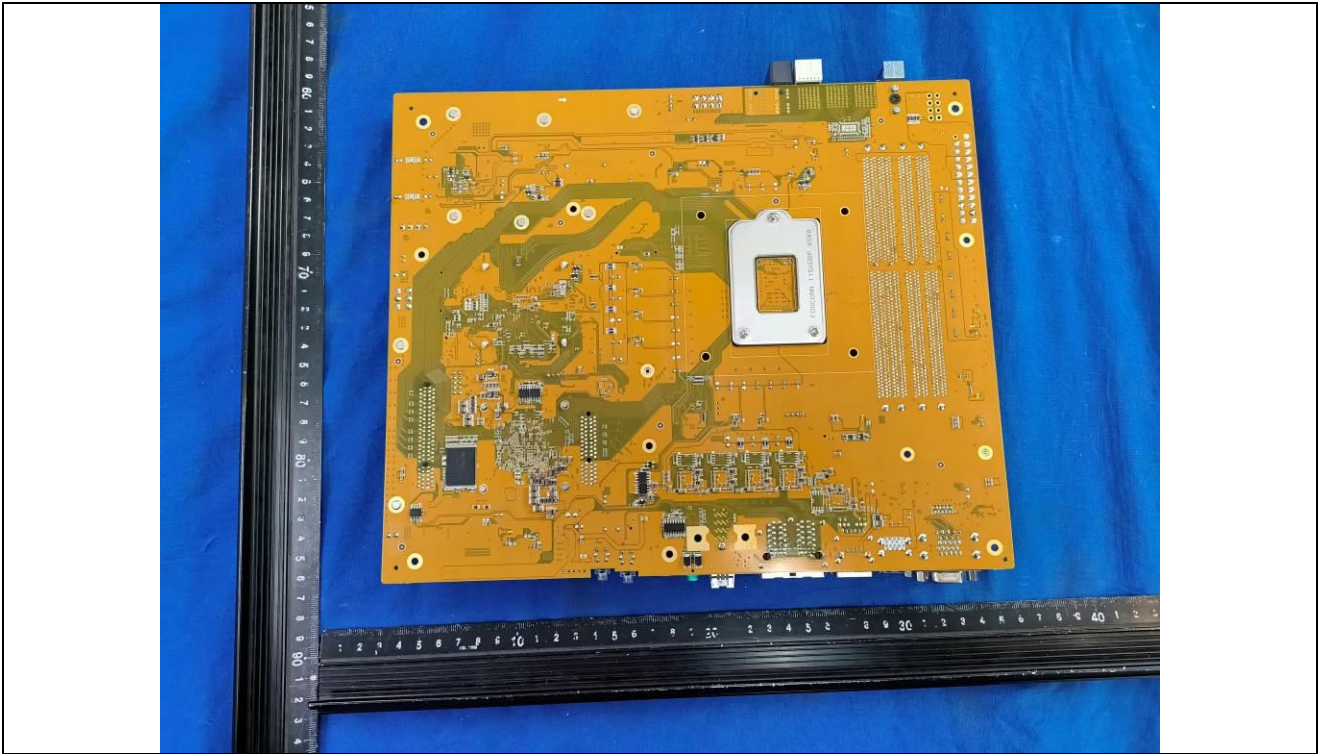

Details of: Internal View

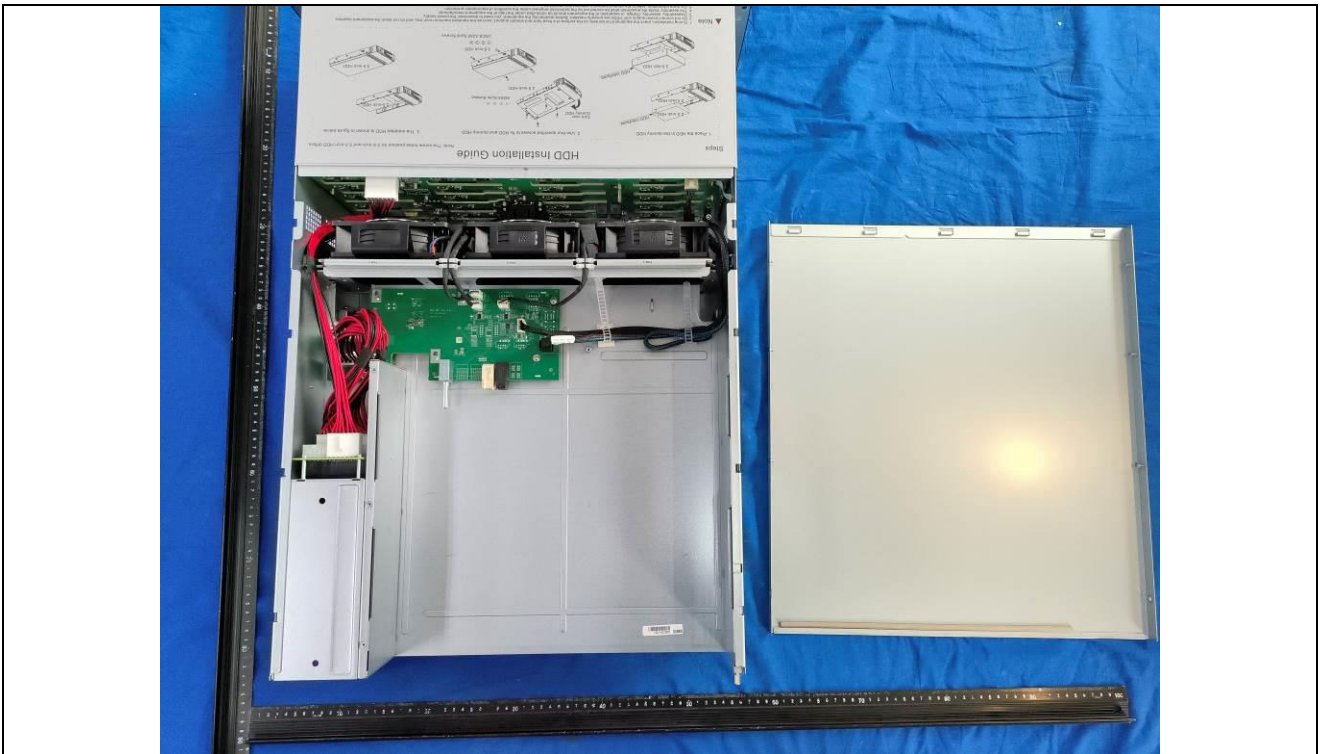

Details of: Internal View

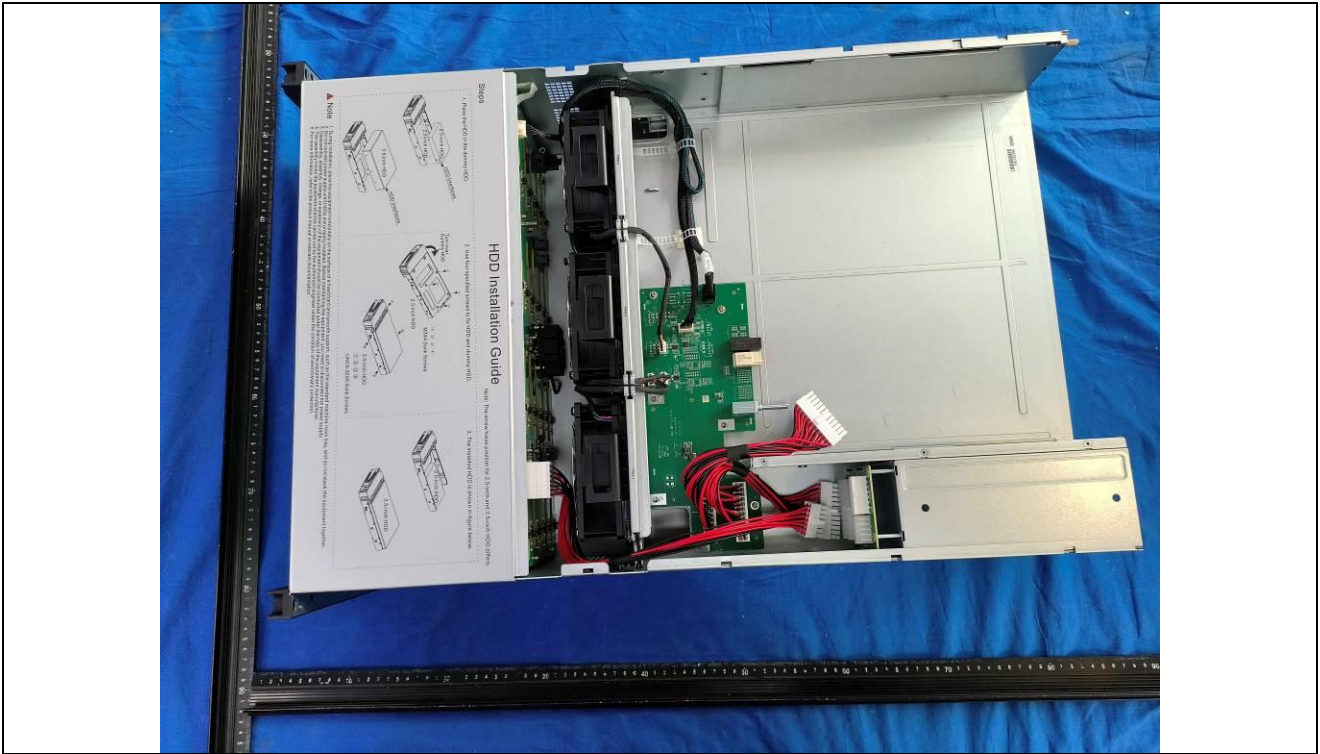

Details of: Internal View

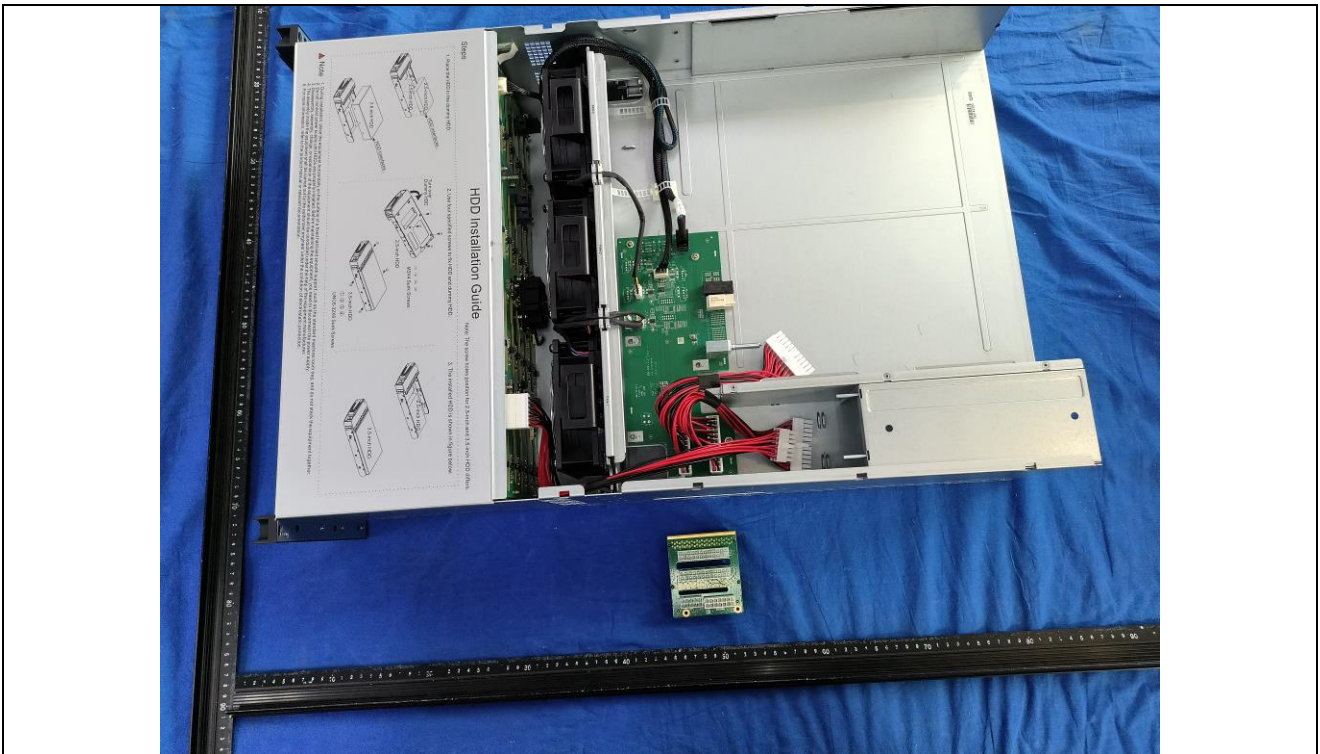

Details of: PCB

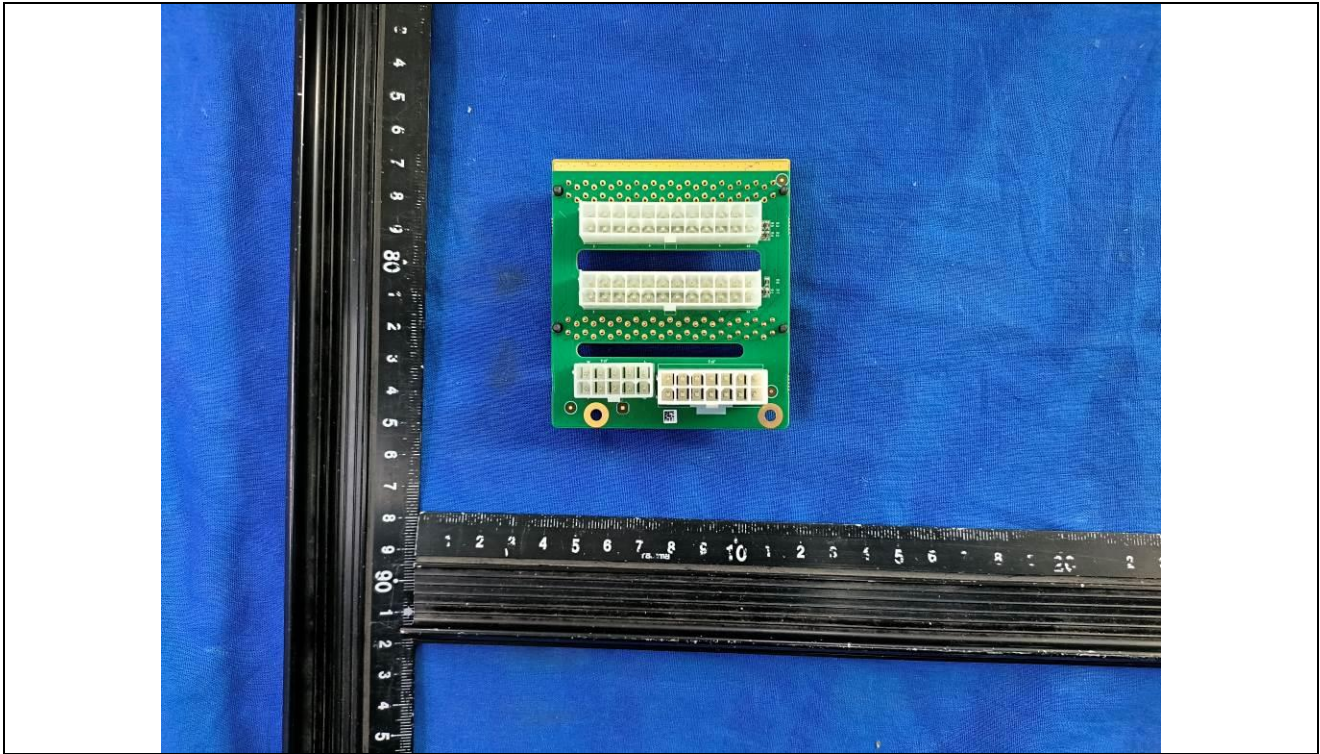

Details of: PCB

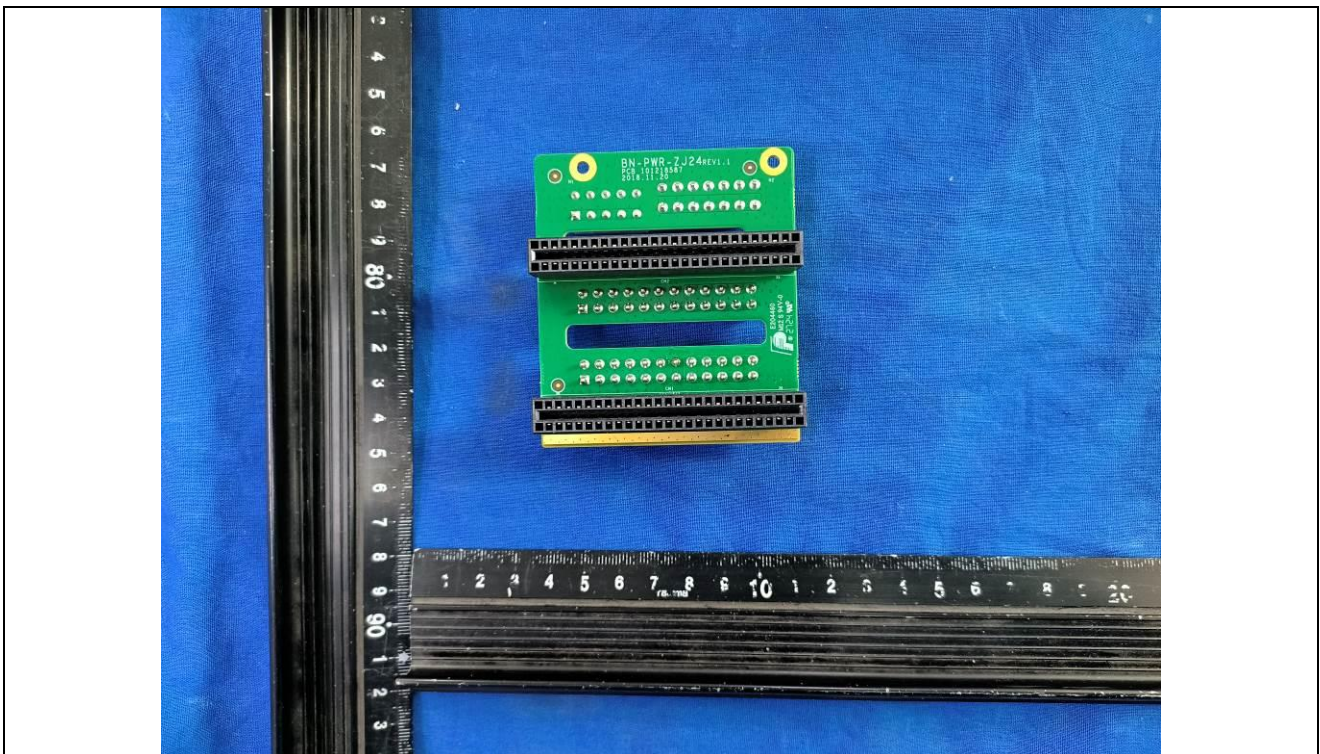

Details of: Internal View

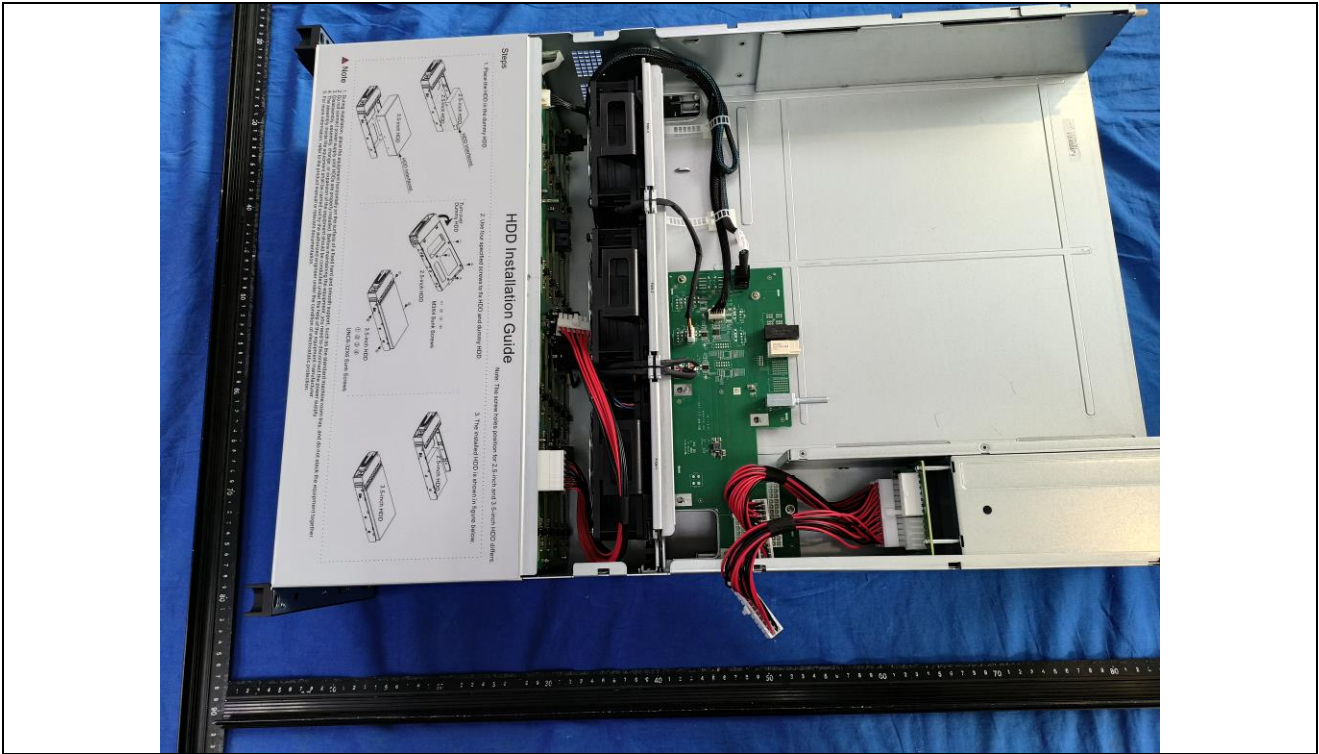

Details of: Internal View

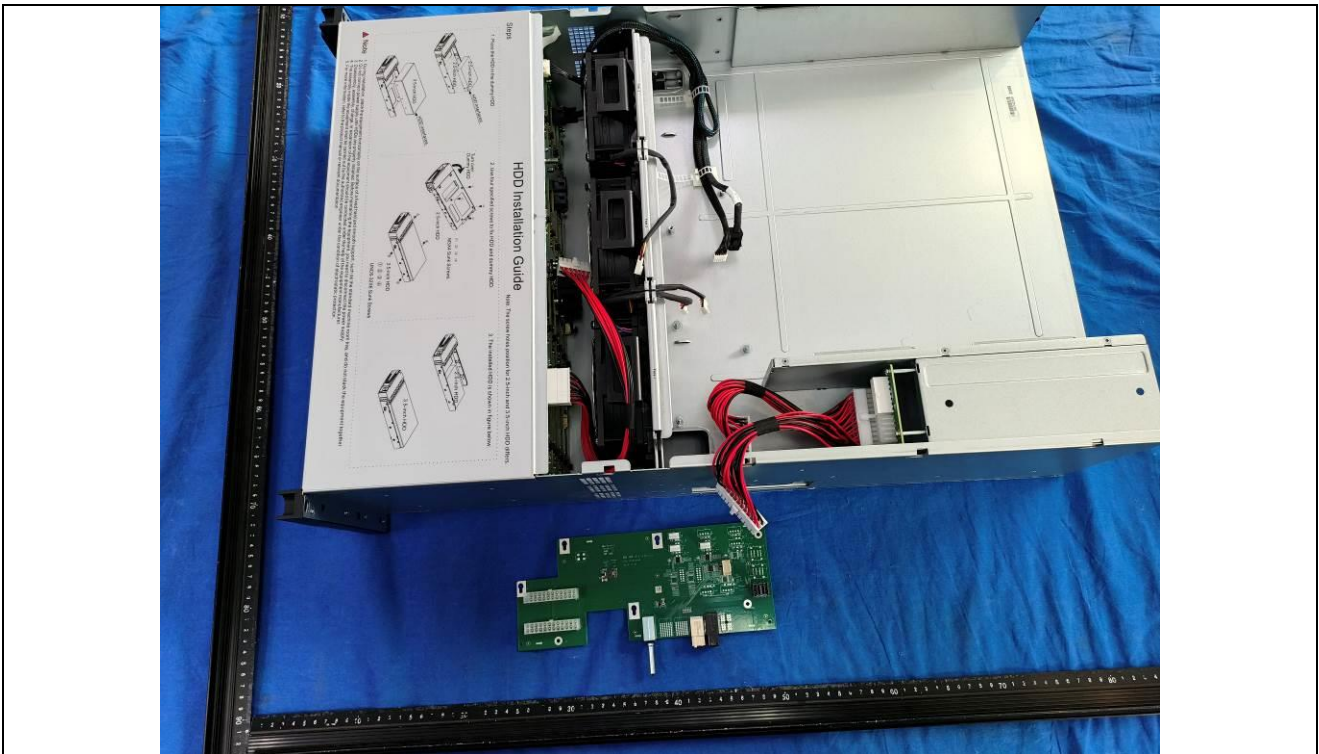

Details of: PCB

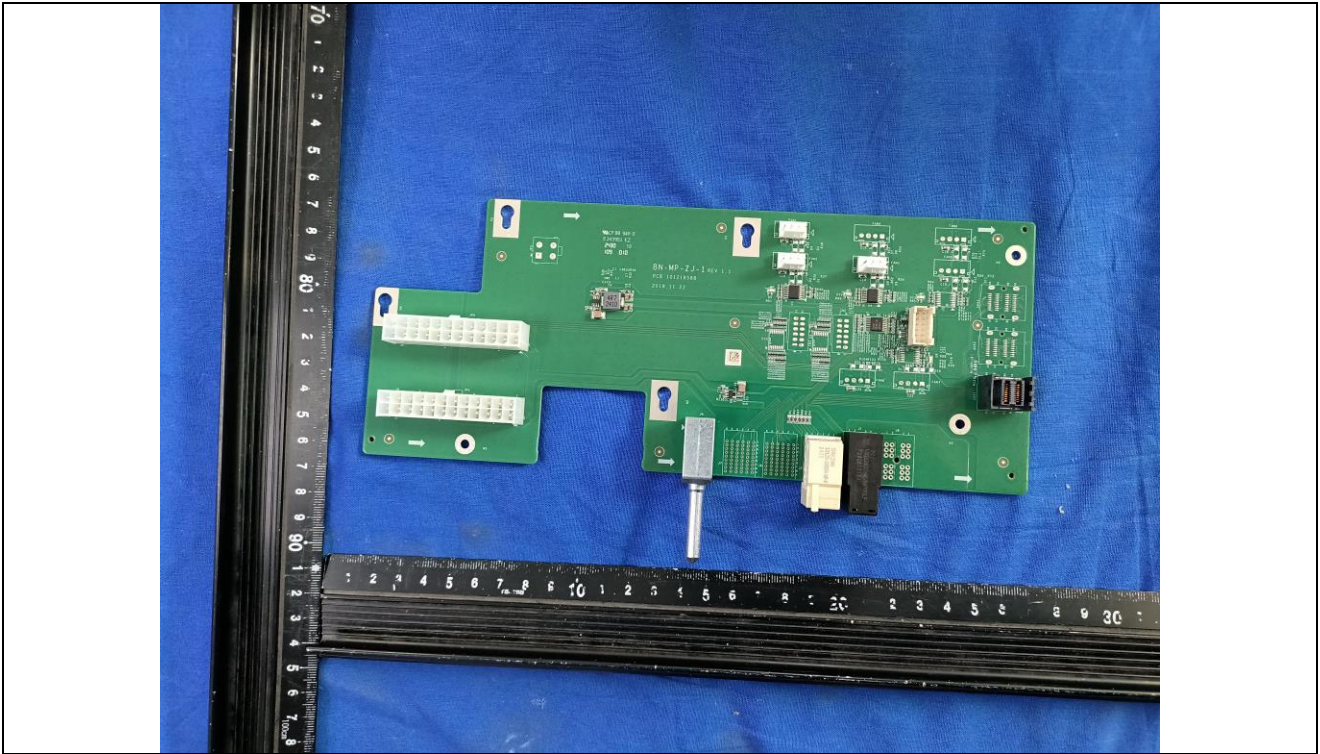

Details of: PCB

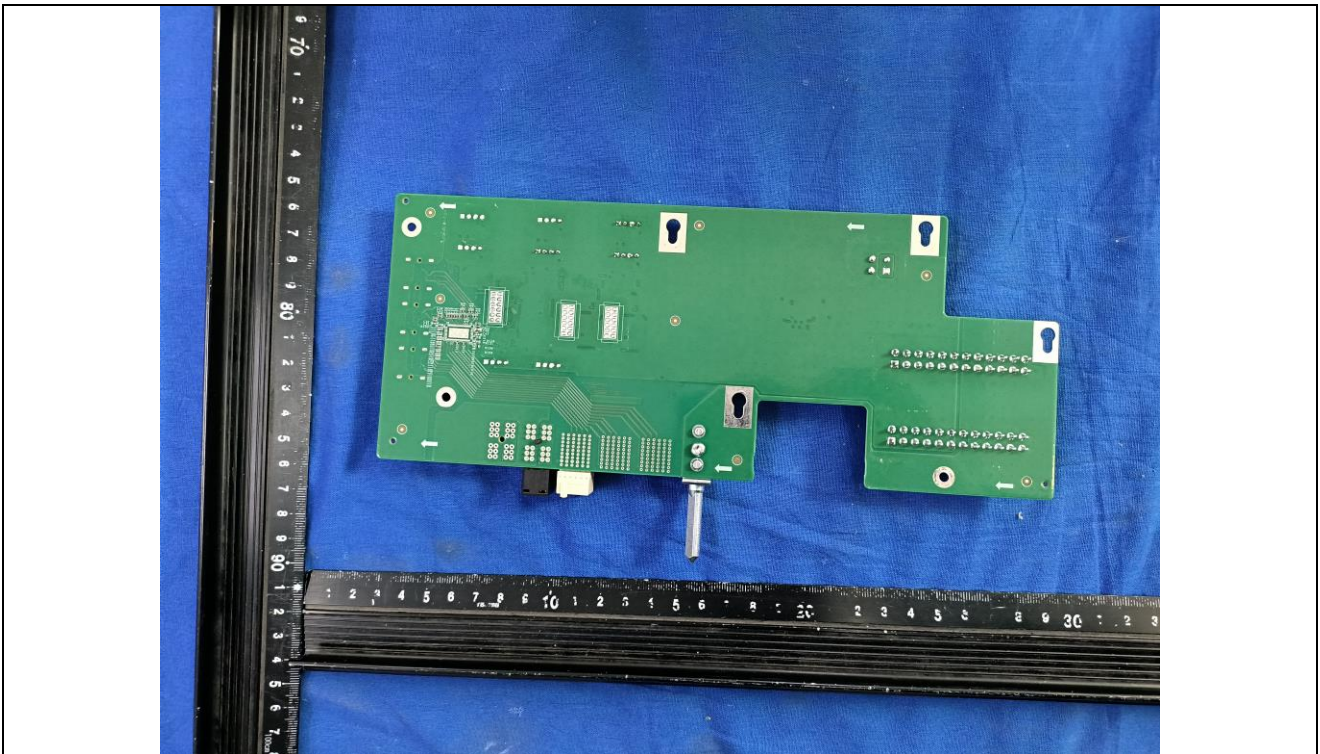

Details of: Internal View

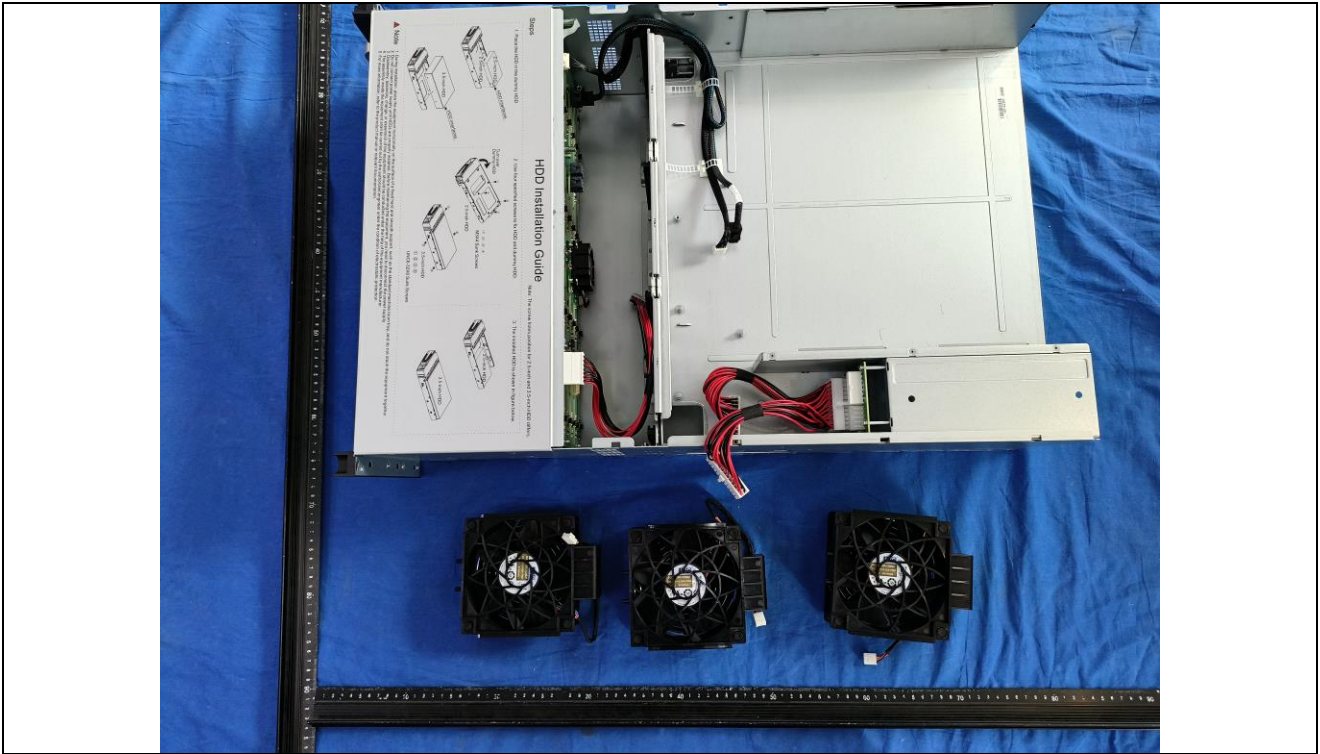

Details of: PCB

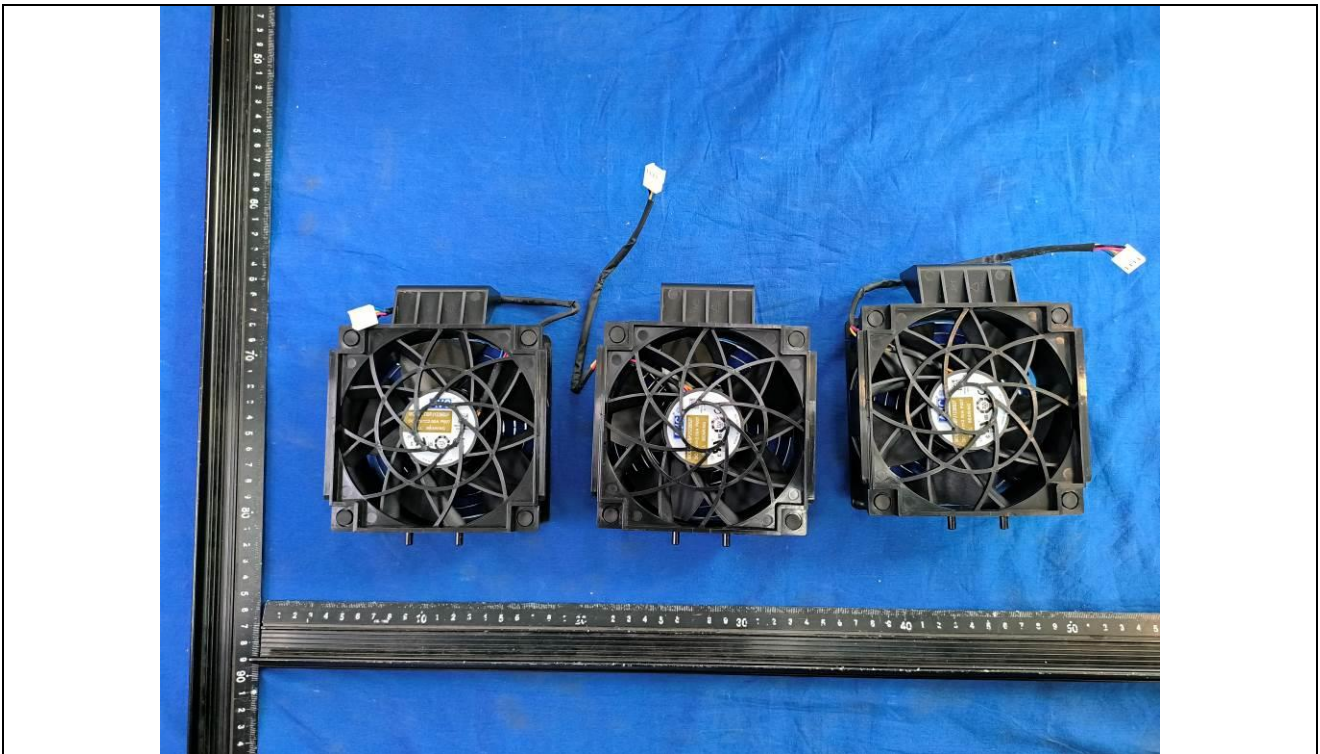

Details of: PCB



Details of: Internal View

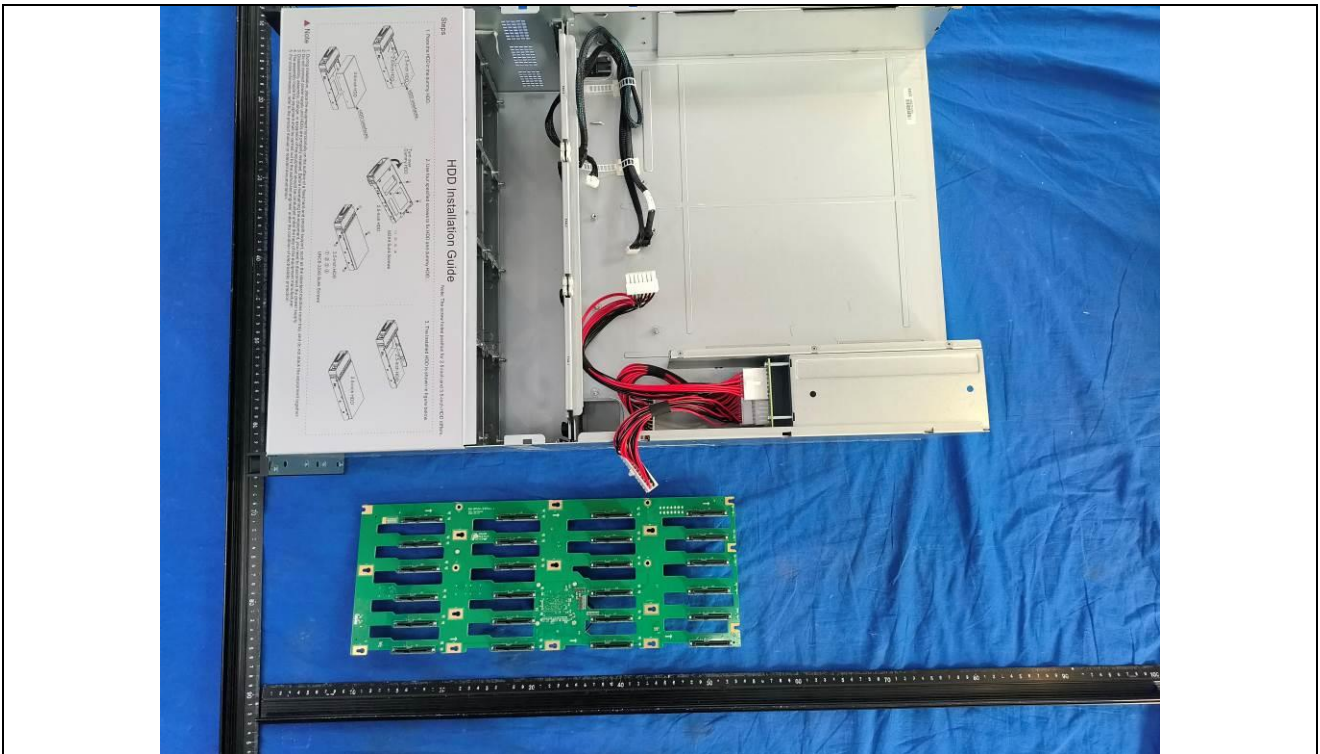

Details of: Internal View

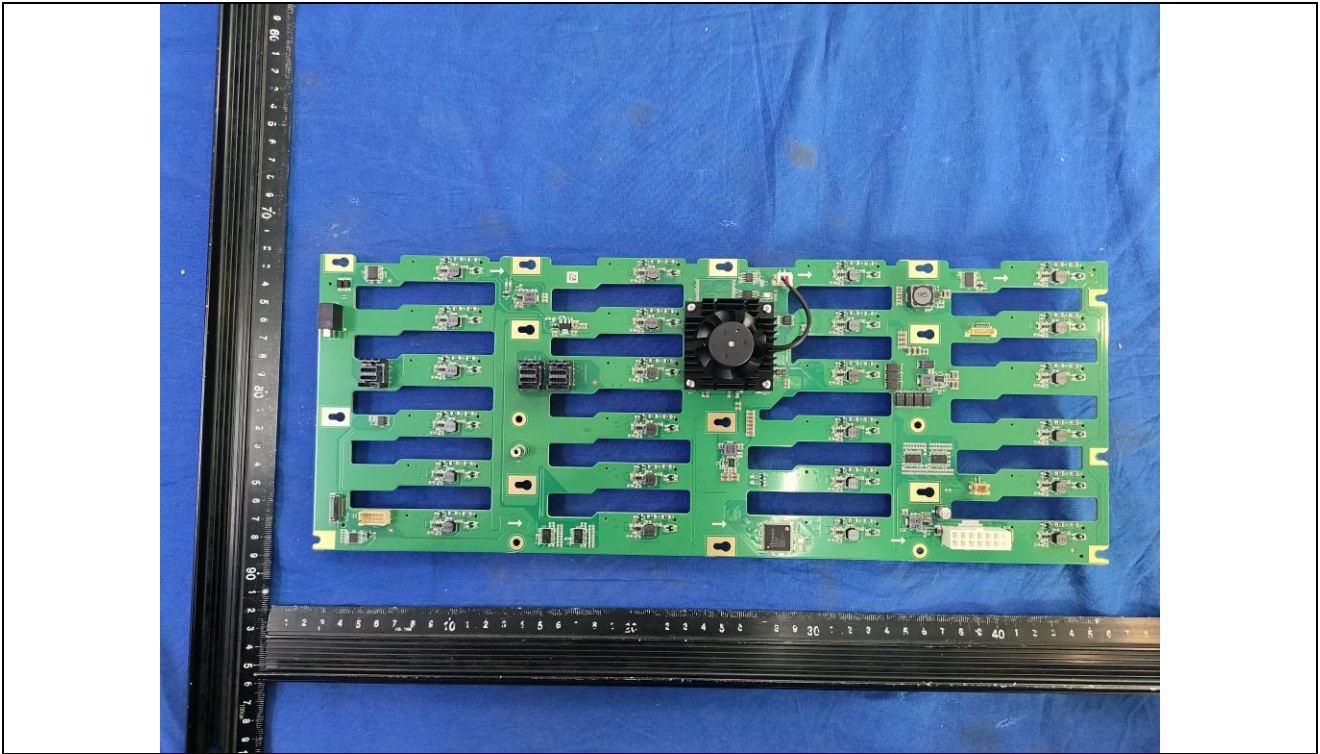

Details of: Internal View

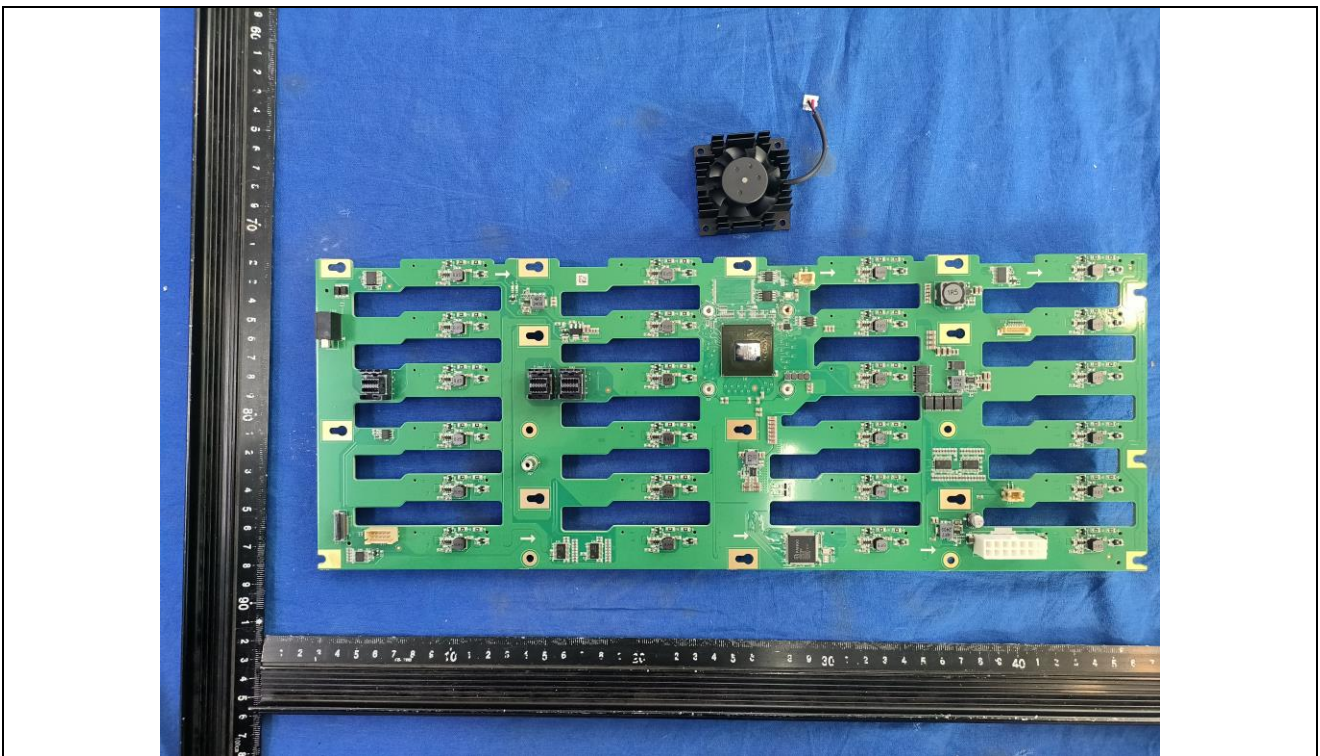

Details of: PCB

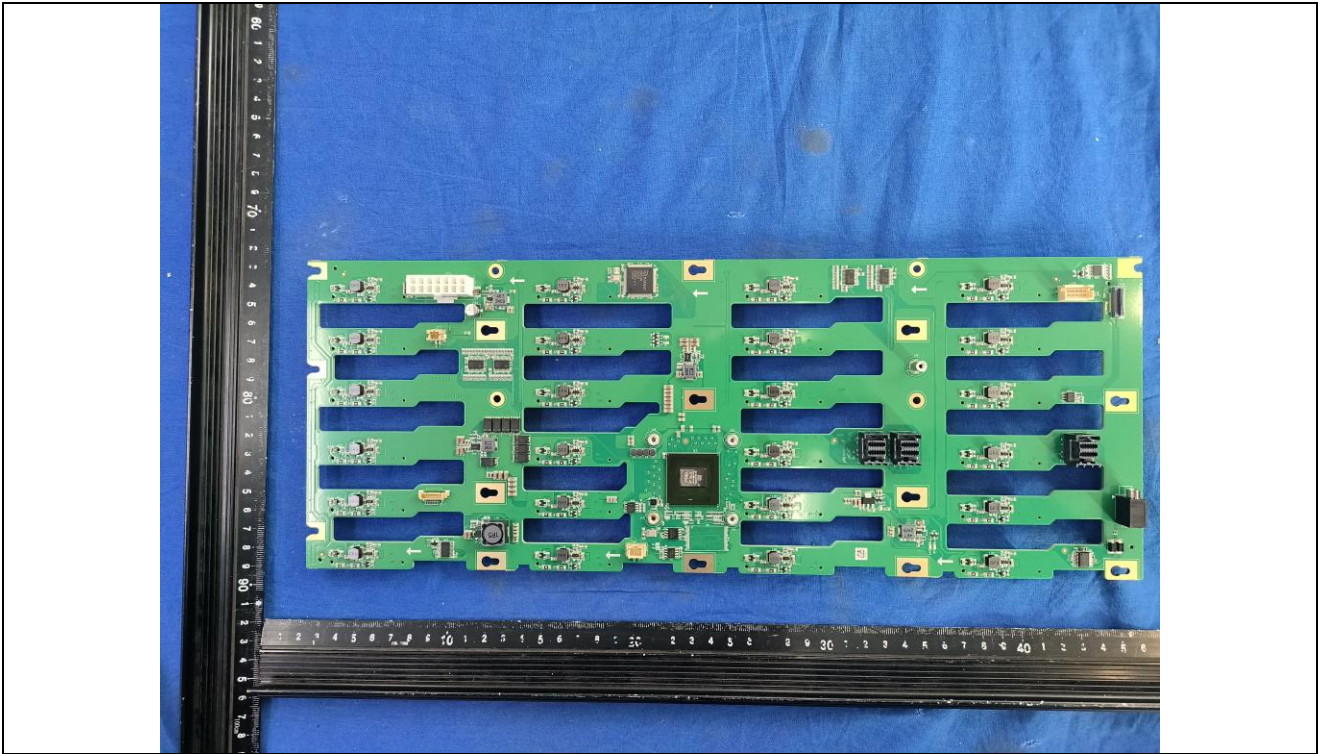

Details of: PCB

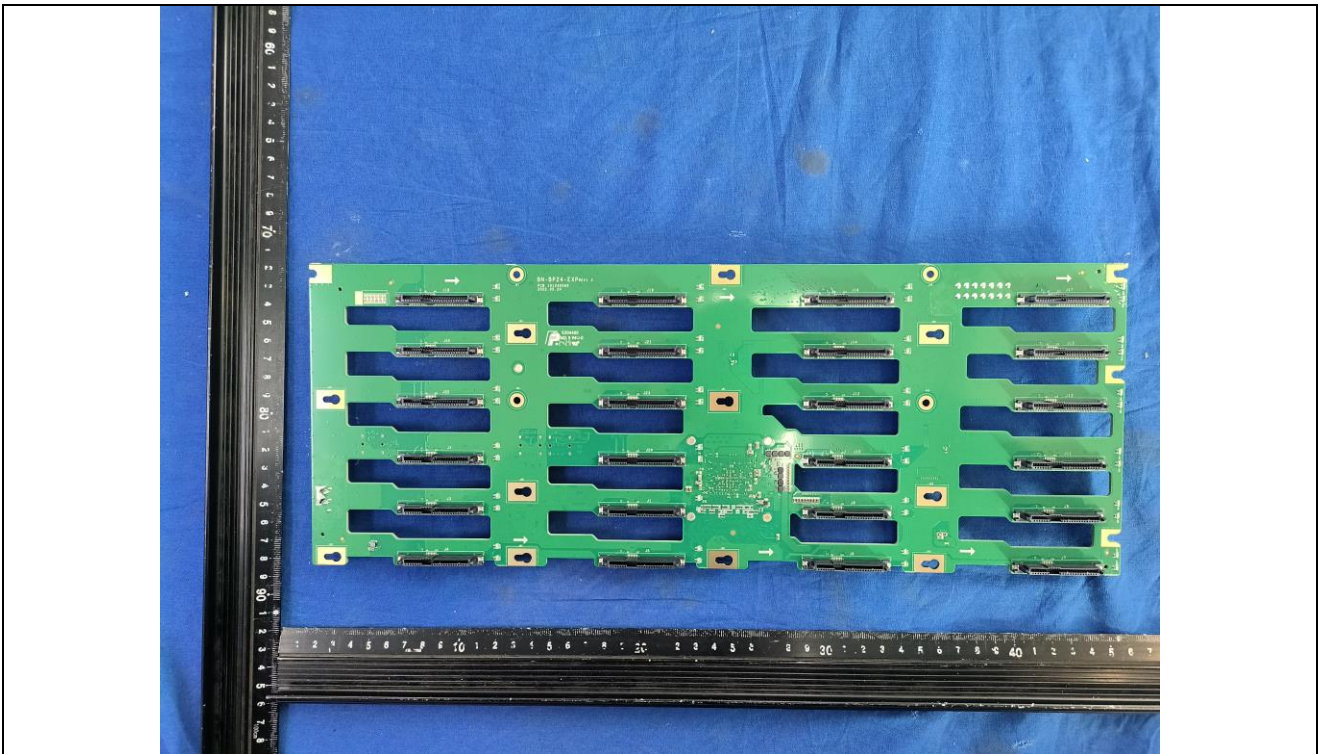

*****End of Attachment 1*****

IEC62368_1E - ATTACHMENT			
Clause	Requirement + Test	Result - Remark	Verdict
ATTACHMENT TO TEST REPORT IEC 62368-1 EUROPEAN GROUP DIFFERENCES AND NATIONAL DIFFERENCES (Audio/video, information and communication technology equipment - Part 1: Safety requirements)			
Differences according to : EN IEC 62368-1:2020+A11:2020			
Attachment Form No. : EU_GD_IEC62368_1E			
Attachment Originator : UL(Demko)			
Master Attachment : 2021-02-04			
Copyright © 2021 IEC System for Conformity Testing and Certification of Electrical Equipment (IECEE), Geneva, Switzerland. All rights reserved.			
	CENELEC COMMON MODIFICATIONS (EN)		P
	Clause numbers in the cells that are shaded light grey are clause references in EN IEC 62368-1:2020+A11:2020. All other clause numbers in that column, except for those in the paragraph below, refers to IEC 62368-1:2018. Clauses, subclauses, notes, tables, figures and annexes which are additional to those in IEC 62368-1:2018 are prefixed "Z".		P
	Add the following annexes: Annex ZA (normative) Normative references to international publications with their corresponding European publications Annex ZB (normative) Special national conditions Annex ZC (informative) A-deviations Annex ZD (informative) IEC and CENELEC code designations for flexible cords		P
1	Modification to Clause 3 .		N/A
3.3.19	Sound exposure <i>Replace 3.3.19 of IEC 62368-1 with the following definitions:</i>		N/A

IEC 62368-1			
Clause	Requirement + Test	Result - Remark	Verdict
3.3.19.1	<p>momentary exposure level, MEL</p> <p>metric for estimating 1 s sound exposure level from the HD 483-1 S2 test signal applied to both channels, based on EN 50332-1:2013, 4.2.</p> <p>Note 1 to entry: MEL is measured as A-weighted levels in dB. Note 2 to entry: See B.3 of EN 50332-3:2017 for additional information.</p>		N/A
3.3.19.3	<p>sound exposure, E</p> <p>A-weighted sound pressure (p) squared and integrated over a stated period of time, T</p> <p>Note 1 to entry: The SI unit is Pa² s.</p> $E = \int_0^T p(t)^2 dt$		N/A
3.3.19.4	<p>sound exposure level, SEL</p> <p>logarithmic measure of sound exposure relative to a reference value, E_0, typically the 1 kHz threshold of hearing in humans.</p> <p>Note 1 to entry: SEL is measured as A-weighted levels in dB.</p> $SEL = 10 \lg \left(\frac{E}{E_0} \right) \text{ dB}$ <p>Note 2 to entry: See B.4 of EN 50332-3:2017 for additional information.</p>		N/A
3.3.19.5	<p>digital signal level relative to full scale, dBFS</p> <p>levels reported in dBFS are always r.m.s. Full scale level, 0 dBFS, is the level of a dc-free 997-Hz sine wave whose undithered positive peak value is positive digital full scale, leaving the code corresponding to negative digital full scale unused</p> <p>Note 1 to entry: It is invalid to use dBFS for non-r.m.s. levels. Because the definition of full scale is based on a sine wave, the level of signals with a crest factor lower than that of a sine wave may exceed 0 dBFS. In particular, square wave signals may reach +3,01 dBFS.</p>		N/A
2	Modification to Clause 10		N/A
10.6	<p>Safeguards against acoustic energy sources</p> <p>Replace 10.6 of IEC 62368-1 with the following:</p>		N/A
10.6.1.1	<p>Introduction</p> <p>Safeguard requirements for protection against long-term exposure to excessive sound pressure levels from personal music players closely coupled</p>		N/A

IEC 62368-1			
Clause	Requirement + Test	Result - Remark	Verdict
	<p>to the ear are specified below. Requirements for earphones and headphones intended for use with personal music players are also covered. A personal music player is a portable equipment intended for use by an ordinary person, that:</p> <ul style="list-style-type: none"> – is designed to allow the user to listen to audio or audiovisual content / material; and – uses a listening device, such as headphones or earphones that can be worn in or on or around the ears; and – has a player that can be body worn (of a size suitable to be carried in a clothing pocket) and is intended for the user to walk around with while in continuous use (for example, on a street, in a subway, at an airport, etc.). <p>EXAMPLES Portable CD players, MP3 audio players, mobile phones with MP3 type features, PDAs or similar equipment.</p> <p>Personal music players shall comply with the requirements of either 10.6.2 or 10.6.3.</p> <p>NOTE 1 Protection against acoustic energy sources from telecom applications is referenced to ITU-T P.360.</p> <p>NOTE 2 It is the intention of the Committee to allow the alternative methods for now, but to only use the dose measurement method as given in 10.6.5 in future. Therefore, manufacturers are encouraged to implement 10.6.5 as soon as possible.</p> <p>Listening devices sold separately shall comply with the requirements of 10.6.6. These requirements are valid for music or video mode only. The requirements do not apply to:</p> <ul style="list-style-type: none"> – professional equipment; <p>NOTE 3 Professional equipment is equipment sold through special sales channels. All products sold through normal electronics stores are considered not to be professional equipment.</p> <ul style="list-style-type: none"> – hearing aid equipment and other devices for assistive listening; – the following type of analogue personal music players: <ul style="list-style-type: none"> • long distance radio receiver (for example, a multiband radio receiver or world band radio receiver, an AM radio receiver), and • cassette player/recorder; <p>NOTE 4 This exemption has been allowed because this technology is falling out of use and it is expected that within a few years it will no longer exist. This exemption will not be extended to other technologies.</p> <ul style="list-style-type: none"> – a player while connected to an external amplifier that does not allow the user to walk around 		

IEC 62368-1			
Clause	Requirement + Test	Result - Remark	Verdict
	<p>while in use.</p> <p>For equipment that is clearly designed or intended primarily for use by children, the limits of the relevant toy standards may apply.</p> <p>The relevant requirements are given in EN 71-1:2011, 4.20 and the related tests methods and measurement distances apply.</p>		
10.6.1.2	<p>Non-ionizing radiation from radio frequencies in the range 0 to 300 GHz</p> <p>The amount of non-ionizing radiation is regulated by European Council Recommendation 1999/519/EC of 12 July 1999 on the limitation of exposure of the general public to electromagnetic fields (0 Hz to 300 GHz).</p> <p>For intentional radiators, ICNIRP guidelines should be taken into account for Limiting Exposure to Time-Varying Electric, Magnetic, and Electromagnetic Fields (up to 300 GHz). For hand-held and body mounted devices, attention is drawn to EN 50360 and EN 50566.</p>		N/A
10.6.2	Classification of devices without the capacity to estimate sound dose		N/A
10.6.2.1	<p>General</p> <p>This standard is transitioning from short-term based (30 s) requirements to long-term based (40 hour) requirements. These clauses remain in effect only for devices that do not comply with sound dose estimation as stipulated in EN 50332-3.</p> <p>For classifying the acoustic output $L_{Aeq,T}$, measurements are based on the A-weighted equivalent sound pressure level over a 30 s period.</p> <p>For music where the average sound pressure (long term $L_{Aeq,T}$) measured over the duration of the song is lower than the average produced by the programme simulation noise, measurements may be done over the duration of the complete song. In this case, T becomes the duration of the song.</p> <p>NOTE Classical music, acoustic music and broadcast typically has an average sound pressure (long term $L_{Aeq,T}$) which is much lower than the average programme simulation noise. Therefore, if the player is capable to analyse the content and compare it with the programme simulation noise, the warning does not need to be given as long as the average sound pressure of the song does not exceed the required limit. For example, if the player is set with the programme simulation noise to 85 dB, but the average music level of the song is only 65 dB, there is no need to give a warning or ask an acknowledgement as long as the average sound level of the song is not above the basic limit of 85 dB.</p>		N/A
10.6.2.2	RS1 limits (to be superseded, see 10.6.3.2)		N/A

IEC 62368-1			
Clause	Requirement + Test	Result - Remark	Verdict
	<p>RS1 is a class 1 acoustic energy source that does not exceed the following:</p> <ul style="list-style-type: none"> – for equipment provided as a package (player with its listening device), and with a proprietary connector between the player and its listening device, or where the combination of player and listening device is known by other means such as setting or automatic detection, the $L_{Aeq,T}$ acoustic output shall be ≤ 85 dB when playing the fixed “programme simulation noise” described in EN 50332-1. – for equipment provided with a standardized connector (for example, a 3,5 phone jack) that allows connection to a listening device for general use, the unweighted r.m.s. output voltage shall be ≤ 27 mV (analogue interface) or -25 dBFS (digital interface) when playing the fixed “programme simulation noise” described in EN 50332-1. – The RS1 limits will be updated for all devices as per 10.6.3.2. 		
10.6.2.3	<p>RS2 limits (to be superseded, see 10.6.3.3)</p> <p>RS2 is a class 2 acoustic energy source that does not exceed the following:</p> <ul style="list-style-type: none"> – for equipment provided as a package (player with its listening device), and with a proprietary connector between the player and its listening device, or when the combination of player and listening device is known by other means such as setting or automatic 130 detection, the $L_{Aeq,T}$ acoustic output shall be ≤ 100 dB(A) when playing the fixed “programme simulation noise” as described in EN 50332-1. – for equipment provided with a standardized connector (for example, a 3,5 phone jack) that allows connection to a listening device for general use, the unweighted r.m.s. output voltage shall be ≤ 150 mV (analogue interface) or -10 dBFS (digital interface) when playing the fixed “programme simulation noise” as described in EN 50332-1. 		N/A
10.6.2.4	<p>RS3 limits</p> <p>RS3 is a class 3 acoustic energy source that exceeds RS2 limits.</p>		N/A
10.6.3	Classification of devices (new)		N/A
10.6.3.1	General		
	<p>Previous limits (10.6.2) created abundant false negative and false positive PMP sound level warnings. New limits, compliant with The Commission Decision of 23 June 2009, are given below.</p>		

IEC 62368-1			
Clause	Requirement + Test	Result - Remark	Verdict
10.6.3.2	<p>RS1 limits (new)</p> <p>RS1 is a class 1 acoustic energy source that does not exceed the following:</p> <ul style="list-style-type: none"> – for equipment provided as a package (player with its listening device), and with a proprietary connector between the player and its listening device, or where the combination of player and listening device is known by other means such as setting or automatic detection, the $L_{Aeq,T}$ acoustic output shall be ≤ 80 dB when playing the fixed “programme simulation noise” described in EN 50332-1. – for equipment provided with a standardized connector (for example, a 3,5 phone jack) that allows connection to a listening device for general use, the unweighted r.m.s. output voltage shall be ≤ 15 mV (analogue interface) or -30 dBFS (digital interface) when playing the fixed “programme simulation noise” described in EN 50332-1. 		N/A
10.6.3.3	<p>RS2 limits (new)</p> <p>RS2 is a class 2 acoustic energy source that does not exceed the following:</p> <ul style="list-style-type: none"> – for equipment provided as a package (player with its listening device), and with a proprietary connector between the player and its listening device, or where the combination of player and listening device is known by other means such as setting or automatic detection, the weekly sound exposure level, as described in EN 50332-3, shall be ≤ 80 dB when playing the fixed "programme simulation noise" described in EN 50332-1. – for equipment provided with a standardized connector (for example, a 3,5 phone jack) that allows connection to a listening device for general use, the unweighted r.m.s. output level, integrated over one week, as described in EN50332-3, shall be ≤ 15 mV (analogue interface) or -30 dBFS (digital interface) when playing the fixed “programme simulation noise” described in EN 50332-1. 		N/A
10.6.4	Requirements for maximum sound exposure		N/A
10.6.4.1	<p>Measurement methods</p> <p>All volume controls shall be turned to maximum during tests.</p> <p>Measurements shall be made in accordance with EN 50332-1 or EN 50332-2 as applicable.</p>		N/A
10.6.4.2	<p>Protection of persons</p> <p>Except as given below, protection requirements for parts accessible to ordinary persons, instructed persons and skilled persons are given in 4.3.</p>		N/A

IEC 62368-1			
Clause	Requirement + Test	Result - Remark	Verdict
	<p>NOTE 1 Volume control is not considered a safeguard.</p> <p>Between RS2 and an ordinary person, the basic safeguard may be replaced by an instructional safeguard in accordance with Clause F.5, except that the instructional safeguard shall be placed on the equipment, or on the packaging, or in the instruction manual.</p> <p>Alternatively, the instructional safeguard may be given through the equipment display during use.</p> <p>The elements of the instructional safeguard shall be as follows:</p> <ul style="list-style-type: none"> – element 1a: the symbol , IEC 60417-6044 (2011-01) – element 2: “High sound pressure” or equivalent wording – element 3: “Hearing damage risk” or equivalent wording – element 4: “Do not listen at high volume levels for long periods.” or equivalent wording <p>An equipment safeguard shall prevent exposure of an ordinary person to an RS2 source without intentional physical action from the ordinary person and shall automatically return to an output level not exceeding what is specified for an RS1 source when the power is switched off.</p> <p>The equipment shall provide a means to actively inform the user of the increased sound level when the equipment is operated with an output exceeding RS1. Any means used shall be acknowledged by the user before activating a mode of operation which allows for an output exceeding RS1. The acknowledgement does not need to be repeated more than once every 20 h of cumulative listening time.</p> <p>NOTE 2 Examples of means include visual or audible signals. Action from the user is always needed.</p> <p>NOTE 3 The 20 h listening time is the accumulative listening time, independent of how often and how long the personal music player has been switched off.</p> <p>A skilled person shall not be unintentionally exposed to RS3.</p>		
10.6.5	Requirements for dose-based systems		N/A
10.6.5.1	General requirements		N/A
	Personal music players shall give the warnings as provided below when tested according to EN 50332-3, using the limits from this clause.		

IEC 62368-1			
Clause	Requirement + Test	Result - Remark	Verdict
	<p>The manufacturer may offer optional settings to allow the users to modify when and how they wish to receive the notifications and warnings to promote a better user experience without defeating the safeguards. This allows the users to be informed in a method that best meets their physical capabilities and device usage needs. If such optional settings are offered, an administrator (for example, parental restrictions, business/educational administrators, etc.) shall be able to lock any optional settings into a specific configuration.</p> <p>The personal music player shall be supplied with easy to understand explanation to the user of the dose management system, the risks involved, and how to use the system safely. The user shall be made aware that other sources may significantly contribute to their sound exposure, for example work, transportation, concerts, clubs, cinema, car races, etc.</p>		
10.6.5.2	<p>Dose-based warning and requirements</p> <p>When a dose of 100 % <i>CSD</i> is reached, and at least at every 100 % further increase of <i>CSD</i>, the device shall warn the user and require an acknowledgement. In case the user does not acknowledge, the output level shall automatically decrease to compliance with class RS1.</p> <p>The warning shall at least clearly indicate that listening above 100 % <i>CSD</i> leads to the risk of hearing damage or loss.</p>		N/A
10.6.5.3	<p>Exposure-based requirements</p> <p>With only dose-based requirements, cause and effect could be far separated in time, defying the purpose of educating users about safe listening practice. In addition to dose-based requirements, a PMP shall therefore also put a limit to the short-term sound level a user can listen at.</p> <p>The exposure-based limiter (EL) shall automatically reduce the sound level not to exceed 100 dB(A) or 150 mV integrated over the past 180 s, based on methodology defined in EN 50332-3. The EL settling time (time from starting level reduction to reaching target output) shall be 10 s or faster.</p> <p>Test of EL functionality is conducted according to EN 50332-3, using the limits from this clause. For equipment provided as a package (player with its listening device), the level integrated over 180 s shall be 100 dB or lower. For equipment provided</p>		N/A

IEC 62368-1			
Clause	Requirement + Test	Result - Remark	Verdict
	<p>with a standardized connector, the unweighted level integrated over 180 s shall be no more than 150 mV for an analogue interface and no more than -10 dBFS for a digital interface.</p> <p>NOTE In case the source is known not to be music (or test signal), the EL may be disabled.</p>		

IEC 62368-1			
Clause	Requirement + Test	Result - Remark	Verdict
10.6.6	Requirements for listening devices (headphones, earphones, etc.)		N/A
10.6.6.1	<p>Corded listening devices with analogue input</p> <p>With 94 dB L_{Aeq} acoustic pressure output of the listening device, and with the volume and sound settings in the listening device (for example, built-in volume level control, additional sound features like equalization, etc.) set to the combination of positions that maximize the measured acoustic output, the input voltage of the listening device when playing the fixed “programme simulation noise” as described in EN 50332-1 shall be ≥ 75 mV.</p> <p>NOTE The values of 94 dB and 75 mV correspond with 85 dB and 27 mV or 100 dB and 150 mV.</p>		N/A
10.6.6.2	<p>Corded listening devices with digital input</p> <p>With any playing device playing the fixed “programme simulation noise” described in EN 50332-1, and with the volume and sound settings in the listening device (for example, built-in volume level control, additional sound features like equalization, etc.) set to the combination of positions that maximize the measured acoustic output, the $L_{Aeq,T}$ acoustic output of the listening device shall be ≤ 100 dB with an input signal of -10 dBFS.</p>		N/A
10.6.6.3	<p>Cordless listening devices</p> <p>In cordless mode,</p> <ul style="list-style-type: none"> – with any playing and transmitting device playing the fixed programme simulation noise described in EN 50332-1; and – respecting the cordless transmission standards, where an air interface standard exists that specifies the equivalent acoustic level; and – with volume and sound settings in the receiving device (for example, built-in volume level control, additional sound features like equalization, etc.) set to the combination of positions that maximize the measured acoustic output for the above mentioned programme simulation noise, the $L_{Aeq,T}$ acoustic output of the listening device shall be ≤ 100 dB with an input signal of -10 dBFS. 		N/A
10.6.6.4	<p>Measurement method</p> <p><i>Measurements shall be made in accordance with EN 50332-2 as applicable.</i></p>		N/A
3	Modification to the whole document		N/A

IEC 62368-1			
Clause	Requirement + Test	Result - Remark	Verdict

	<p>Delete all the “country” notes in the reference document according to the following list:</p> <table border="1"> <tbody> <tr> <td>0.2.1</td> <td>Note 1 and 2</td> <td>1</td> <td>Note 4 and 5</td> <td>3.3.8.1</td> <td>Note 2</td> </tr> <tr> <td>3.3.8.3</td> <td>Note 1</td> <td>4.1.15</td> <td>Note</td> <td>4.7.3</td> <td>Note 1 and 2</td> </tr> <tr> <td>5.2.2.2</td> <td>Note</td> <td>5.4.2.3.2.2 Table 12</td> <td>Note c</td> <td>5.4.2.3.2.4</td> <td>Note 1 and 3</td> </tr> <tr> <td>5.4.2.3.2.4 Table 13</td> <td>Note 2</td> <td>5.4.2.5</td> <td>Note 2</td> <td>5.4.5.1</td> <td>Note</td> </tr> <tr> <td>5.4.10.2.1</td> <td>Note</td> <td>5.4.10.2.2</td> <td>Note</td> <td>5.4.10.2.3</td> <td>Note</td> </tr> <tr> <td>5.5.2.1</td> <td>Note</td> <td>5.5.6</td> <td>Note</td> <td>5.6.4.2.1</td> <td>Note 2 and 3 and 4</td> </tr> <tr> <td>5.6.8</td> <td>Note 2</td> <td>5.7.6</td> <td>Note</td> <td>5.7.7.1</td> <td>Note 1 and Note 2</td> </tr> <tr> <td>8.5.4.2.3</td> <td>Note</td> <td>10.2.1 Table 39</td> <td>Note 3 and 4 and 5</td> <td>10.5.3</td> <td>Note 2</td> </tr> <tr> <td>10.6.1</td> <td>Note 3</td> <td>F.3.3.6</td> <td>Note 3</td> <td>Y.4.1</td> <td>Note</td> </tr> <tr> <td>Y.4.5</td> <td>Note</td> <td></td> <td></td> <td></td> <td></td> </tr> </tbody> </table>					0.2.1	Note 1 and 2	1	Note 4 and 5	3.3.8.1	Note 2	3.3.8.3	Note 1	4.1.15	Note	4.7.3	Note 1 and 2	5.2.2.2	Note	5.4.2.3.2.2 Table 12	Note c	5.4.2.3.2.4	Note 1 and 3	5.4.2.3.2.4 Table 13	Note 2	5.4.2.5	Note 2	5.4.5.1	Note	5.4.10.2.1	Note	5.4.10.2.2	Note	5.4.10.2.3	Note	5.5.2.1	Note	5.5.6	Note	5.6.4.2.1	Note 2 and 3 and 4	5.6.8	Note 2	5.7.6	Note	5.7.7.1	Note 1 and Note 2	8.5.4.2.3	Note	10.2.1 Table 39	Note 3 and 4 and 5	10.5.3	Note 2	10.6.1	Note 3	F.3.3.6	Note 3	Y.4.1	Note	Y.4.5	Note					N/A
0.2.1	Note 1 and 2	1	Note 4 and 5	3.3.8.1	Note 2																																																													
3.3.8.3	Note 1	4.1.15	Note	4.7.3	Note 1 and 2																																																													
5.2.2.2	Note	5.4.2.3.2.2 Table 12	Note c	5.4.2.3.2.4	Note 1 and 3																																																													
5.4.2.3.2.4 Table 13	Note 2	5.4.2.5	Note 2	5.4.5.1	Note																																																													
5.4.10.2.1	Note	5.4.10.2.2	Note	5.4.10.2.3	Note																																																													
5.5.2.1	Note	5.5.6	Note	5.6.4.2.1	Note 2 and 3 and 4																																																													
5.6.8	Note 2	5.7.6	Note	5.7.7.1	Note 1 and Note 2																																																													
8.5.4.2.3	Note	10.2.1 Table 39	Note 3 and 4 and 5	10.5.3	Note 2																																																													
10.6.1	Note 3	F.3.3.6	Note 3	Y.4.1	Note																																																													
Y.4.5	Note																																																																	
4	Modification to Clause 1					P																																																												
1	<p>Add the following note:</p> <p><i>NOTE Z1 The use of certain substances in electrical and electronic equipment is restricted within the EU: see Directive 2011/65/EU.</i></p>					P																																																												

IEC 62368-1			
Clause	Requirement + Test	Result - Remark	Verdict
5	Modification to 4.Z1		P
4.Z1	<p>Add the following new subclause after 4.9:</p> <p>To protect against excessive current, short-circuits and earth faults in circuits connected to an a.c. mains, protective devices shall be included either as integral parts of the equipment or as parts of the building installation, subject to the following, a), b) and c):</p> <p>a) except as detailed in b) and c), protective devices necessary to comply with the requirements of B.3.1 and B.4 shall be included as parts of the equipment;</p> <p>b) for components in series with the mains input to the equipment such as the supply cord, appliance coupler, r.f.i. filter and switch, short-circuit and earth fault protection may be provided by protective devices in the building installation;</p> <p>c) it is permitted for pluggable equipment type B or permanently connected equipment, to rely on dedicated overcurrent and short-circuit protection in the building installation, provided that the means of protection, e.g. fuses or circuit breakers, is fully specified in the installation instructions.</p> <p>If reliance is placed on protection in the building installation, the installation instructions shall so state, except that for pluggable equipment type A the building installation shall be regarded as providing protection in accordance with the rating of the wall socket outlet.</p>		P
6	Modification to 5.4.2.3.2.4		N/A
5.4.2.3.2.4	<p>Add the following to the end of this subclause:</p> <p>The requirement for interconnection with external circuit is in addition given in EN 50491-3:2009.</p>		N/A
7	Modification to 10.2.1		N/A
10.2.1	<p>Add the following to ^{c)} and ^{d)} in table 39:</p> <p>For additional requirements, see 10.5.1.</p>		N/A

IEC 62368-1			
Clause	Requirement + Test	Result - Remark	Verdict

8	Modification to 10.5.1		N/A
10.5.1	<p>Add the following after the first paragraph:</p> <p>For RS 1 compliance is checked by measurement under the following conditions:</p> <p>In addition to the normal operating conditions, all controls adjustable from the outside by hand, by any object such as a tool or a coin, and those internal adjustments or pre-sets which are not locked in a reliable manner, are adjusted so as to give maximum radiation whilst maintaining an intelligible picture for 1 h, at the end of which the measurement is made.</p> <p>NOTE Z1 Soldered joints and paint lockings are examples of adequate locking.</p> <p>The dose-rate is determined by means of a radiation monitor with an effective area of 10 cm², at any point 10 cm from the outer surface of the apparatus.</p> <p>Moreover, the measurement shall be made under fault conditions causing an increase of the high voltage, provided an intelligible picture is maintained for 1 h, at the end of which the measurement is made.</p> <p>For RS1, the dose-rate shall not exceed 1 µSv/h taking account of the background level.</p> <p>NOTE Z2 These values appear in Directive 96/29/Euratom of 13 May 1996.</p>		N/A
9	Modification to G.7.1		N/A
G.7.1	<p>Add the following note:</p> <p>NOTE Z1 The harmonized code designations corresponding to the IEC cord types are given in Annex ZD.</p>		N/A

IEC 62368-1			
Clause	Requirement + Test	Result - Remark	Verdict

10	Modification to Bibliography		N/A
	<p>Add the following notes for the standards indicated:</p> <p>IEC 60130-9 NOTE Harmonized as EN 60130-9. IEC 60269-2 NOTE Harmonized as HD 60269-2. IEC 60309-1 NOTE Harmonized as EN 60309-1. IEC 60364 NOTE some parts harmonized in HD 384/HD 60364 series. IEC 60601-2-4 NOTE Harmonized as EN 60601-2-4. IEC 60664-5 NOTE Harmonized as EN 60664-5. IEC 61032:1997 NOTE Harmonized as EN 61032:1998 (not modified). IEC 61508-1 NOTE Harmonized as EN 61508-1. IEC 61558-2-1 NOTE Harmonized as EN 61558-2-1. IEC 61558-2-4 NOTE Harmonized as EN 61558-2-4. IEC 61558-2-6 NOTE Harmonized as EN 61558-2-6. IEC 61643-1 NOTE Harmonized as EN 61643-1. IEC 61643-21 NOTE Harmonized as EN 61643-21. IEC 61643-311 NOTE Harmonized as EN 61643-311. IEC 61643-321 NOTE Harmonized as EN 61643-321. IEC 61643-331 NOTE Harmonized as EN 61643-331.</p>		N/A
11	ADDITION OF ANNEXES		N/A
ZB	ANNEX ZB, SPECIAL NATIONAL CONDITIONS (EN)		N/A
4.1.15	<p>Denmark, Finland, Norway and Sweden</p> <p>To the end of the subclause the following is added: Class I pluggable equipment type A intended for connection to other equipment or a network shall, if safety relies on connection to reliable earthing or if surge suppressors are connected between the network terminals and accessible parts, have a marking stating that the equipment shall be connected to an earthed mains socket-outlet.</p> <p>The marking text in the applicable countries shall be as follows:</p> <p>In Denmark: "Apparatets stikprop skal tilsluttes en stikkontakt med jord som giver forbindelse til stikproppens jord." In Finland: "Laitte on liitettävä suojakoskettimilla varustettuun pistorasiaan" In Norway: "Apparatet må tilkoples jordet stikkontakt" In Sweden: "Apparaten skall anslutas till jordat uttag"</p>		N/A

IEC 62368-1			
Clause	Requirement + Test	Result - Remark	Verdict
4.7.3	<p>United Kingdom</p> <p>To the end of the subclause the following is added:</p> <p>The torque test is performed using a socket-outlet complying with BS 1363, and the plug part shall be assessed to the relevant clauses of BS 1363. Also see Annex G.4.2 of this annex</p>		N/A
5.2.2.2	<p>Denmark</p> <p>After the 2nd paragraph add the following:</p> <p>A warning (marking safeguard) for high touch current is required if the touch current exceeds the limits of 3,5 mA a.c. or 10 mA d.c.</p>		N/A
5.4.11.1 and Annex G	<p>Finland and Sweden</p> <p>To the end of the subclause the following is added:</p> <p>For separation of the telecommunication network from earth the following is applicable:</p> <p>If this insulation is solid, including insulation forming part of a component, it shall at least consist of either</p> <ul style="list-style-type: none"> • two layers of thin sheet material, each of which shall pass the electric strength test below, or • one layer having a distance through insulation of at least 0,4 mm, which shall pass the electric strength test below. <p>If this insulation forms part of a semiconductor component (e.g. an optocoupler), there is no distance through insulation requirement for the insulation consisting of an insulating compound completely filling the casing, so that clearances and creepage distances do not exist, if the component passes the electric strength test in accordance with the compliance clause below and in addition</p> <ul style="list-style-type: none"> • passes the tests and inspection criteria of 5.4.8 with an electric strength test of 1,5 kV multiplied by 1,6 (the electric strength test of 5.4.9 shall be performed using 1,5 kV), <p>and</p> <ul style="list-style-type: none"> • is subject to routine testing for electric strength during manufacturing, using a test voltage of 1,5 kV. <p>It is permitted to bridge this insulation with a capacitor complying with EN 60384-14:2005, subclass Y2.</p>		N/A

IEC 62368-1			
Clause	Requirement + Test	Result - Remark	Verdict
	<p>A capacitor classified Y3 according to EN 60384-14:2005, may bridge this insulation under the following conditions:</p> <ul style="list-style-type: none"> the insulation requirements are satisfied by having a capacitor classified Y3 as defined by EN 60384-14, which in addition to the Y3 testing, is tested with an impulse test of 2,5 kV defined in 5.4.11; the additional testing shall be performed on all the test specimens as described in EN 60384-14; <p>the impulse test of 2,5 kV is to be performed before the endurance test in EN 60384-14, in the sequence of tests as described in EN 60384-14.</p>		
5.5.2.1	<p>Norway</p> <p>After the 3rd paragraph the following is added:</p> <p>Due to the IT power system used, capacitors are required to be rated for the applicable line-to-line voltage (230 V).</p>		P
5.5.6	<p>Finland, Norway and Sweden</p> <p>To the end of the subclause the following is added:</p> <p>Resistors used as basic safeguard or bridging basic insulation in class I pluggable equipment type A shall comply with G.10.1 and the test of G.10.2.</p>		N/A
5.6.1	<p>Denmark</p> <p>Add to the end of the subclause</p> <p>Due to many existing installations where the socket-outlets can be protected with fuses with higher rating than the rating of the socket-outlets the protection for pluggable equipment type A shall be an integral part of the equipment.</p> <p><i>Justification:</i></p> <p>In Denmark an existing 13 A socket outlet can be protected by a 20 A fuse.</p>		N/A
5.6.4.2.1	<p>Ireland and United Kingdom</p> <p>After the indent for pluggable equipment type A, the following is added:</p> <p>– the protective current rating is taken to be 13 A, this being the largest rating of fuse used in the mains plug.</p>		N/A

IEC 62368-1			
Clause	Requirement + Test	Result - Remark	Verdict
5.6.4.2.1	<p>France</p> <p>After the indent for pluggable equipment type A, the following is added: – in certain cases, the protective current rating of the circuit supplied from the mains is taken as 20 A instead of 16 A.</p>		N/A
5.6.5.1	<p>To the second paragraph the following is added:</p> <p>The range of conductor sizes of flexible cords to be accepted by terminals for equipment with a rated current over 10 A and up to and including 13 A is: 1,25 mm² to 1,5 mm² in cross-sectional area.</p>		N/A
5.6.8	<p>Norway</p> <p>To the end of the subclause the following is added: Equipment connected with an earthed mains plug is classified as class I equipment. See the Norway marking requirement in 4.1.15. The symbol IEC 60417-6092, as specified in F.3.6.2, is accepted.</p>		N/A
5.7.6	<p>Denmark</p> <p>To the end of the subclause the following is added:</p> <p>The installation instruction shall be affixed to the equipment if the protective conductor current exceeds the limits of 3,5 mA a.c. or 10 mA d.c.</p>		N/A

IEC 62368-1			
Clause	Requirement + Test	Result - Remark	Verdict
5.7.6.2	<p>Denmark</p> <p>To the end of the subclause the following is added: The warning (marking safeguard) for high touch current is required if the touch current or the protective current exceed the limits of 3,5 mA .</p>		N/A
5.7.7.1	<p>Norway and Sweden</p> <p>To the end of the subclause the following is added: The screen of the television distribution system is normally not earthed at the entrance of the building and there is normally no equipotential bonding system within the building. Therefore the protective earthing of the building installation needs to be isolated from the screen of a cable distribution system.</p> <p>It is however accepted to provide the insulation external to the equipment by an adapter or an interconnection cable with galvanic isolator, which may be provided by a retailer, for example.</p> <p>The user manual shall then have the following or similar information in Norwegian and Swedish language respectively, depending on in what country the equipment is intended to be used in:</p> <p>“Apparatus connected to the protective earthing of the building installation through the mains connection or through other apparatus with a connection to protective earthing – and to a television distribution system using coaxial cable, may in some circumstances create a fire hazard. Connection to a television distribution system therefore has to be provided through a device providing electrical isolation below a certain frequency range (galvanic isolator, see EN 60728-11)”</p> <p>NOTE In Norway, due to regulation for CATV-installations, and in Sweden, a galvanic isolator shall provide electrical insulation below 5 MHz. The insulation shall withstand a dielectric strength of 1,5 kV r.m.s., 50 Hz or 60 Hz, for 1 min.</p> <p>Translation to Norwegian (the Swedish text will also be accepted in Norway):</p> <p>“Apparater som er kopleet til beskyttelsesjord via nettplugg og/eller via annet jordtilkopleet utstyr – og er tilkopleet et koaksialbasert kabel-TV nett, kan forårsake brannfare. For å unngå dette skal det ved tilkopling av apparater til kabel-TV nett installeres en galvanisk isolator mellom apparatet og kabel-TV</p>		N/A

IEC 62368-1			
Clause	Requirement + Test	Result - Remark	Verdict
	<p>nettet.”</p> <p>Translation to Swedish: ”Apparater som är kopplad till skyddsjord via jordat vägguttag och/eller via annan utrustning och samtidigt är kopplad till kabel-TV nät kan i vissa fall medföra risk för brand. För att undvika detta skall vid anslutning av apparaten till kabel-TV nät galvanisk isolator finnas mellan apparaten och kabel-TV nätet.”.</p>		
8.5.4.2.3	<p>United Kingdom</p> <p>Add the following after the 2nd dash bullet in 3rd paragraph:</p> <p>An emergency stop system complying with the requirements of IEC 60204-1 and ISO 13850 is required where there is a risk of personal injury.</p>		N/A
B.3.1 and B.4	<p>Ireland and United Kingdom</p> <p>The following is applicable:</p> <p>To protect against excessive currents and short-circuits in the primary circuit of direct plug-in equipment, tests according to Annexes B.3.1 and B.4 shall be conducted using an external miniature circuit breaker complying with EN 60898-1, Type B, rated 32A. If the equipment does not pass these tests, suitable protective devices shall be included as an integral part of the direct plug-in equipment, until the requirements of Annexes B.3.1 and B.4 are met</p>		N/A

IEC 62368-1			
Clause	Requirement + Test	Result - Remark	Verdict
G.4.2	<p>Denmark</p> <p>To the end of the subclause the following is added:</p> <p>Supply cords of single phase appliances having a rated current not exceeding 13 A shall be provided with a plug according to DS 60884-2-D1:2011.</p> <p>CLASS I EQUIPMENT provided with socket-outlets with earth contacts or which are intended to be used in locations where protection against indirect contact is required according to the wiring rules shall be provided with a plug in accordance with standard sheet DK 2-1a or DK 2-5a.</p> <p>If a single-phase equipment having a RATED CURRENT exceeding 13 A or if a polyphase equipment is provided with a supply cord with a plug, this plug shall be in accordance with the standard sheets DK 6-1a in DS 60884-2-D1 or EN 60309-2.</p> <p>Mains socket outlets intended for providing power to Class II apparatus with a rated current of 2,5 A shall be in accordance DS 60884-2-D1:2011 standard sheet DKA 1-4a.</p> <p>Other current rating socket outlets shall be in compliance with Standard Sheet DKA 1-3a or DKA 1-1c.</p> <p>Mains socket-outlets with earth shall be in compliance with DS 60884-2-D1:2011 Standard Sheet DK 1-3a, DK 1-1c, DK1-1d, DK 1-5a or DK 1-7a</p> <p><i>Justification:</i> Heavy Current Regulations, Section 6c</p>		N/A
G.4.2	<p>United Kingdom</p> <p>To the end of the subclause the following is added:</p> <p>The plug part of direct plug-in equipment shall be assessed to BS 1363: Part 1, 12.1, 12.2, 12.3, 12.9, 12.11, 12.12, 12.13, 12.16, and 12.17, except that the test of 12.17 is performed at not less than 125 °C. Where the metal earth pin is replaced by an Insulated Shutter Opening Device (ISOD), the requirements of clauses 22.2 and 23 also apply.</p>		N/A

IEC 62368-1			
Clause	Requirement + Test	Result - Remark	Verdict
G.7.1	<p>United Kingdom</p> <p>To the first paragraph the following is added:</p> <p>Equipment which is fitted with a flexible cable or cord and is designed to be connected to a mains socket conforming to BS 1363 by means of that flexible cable or cord shall be fitted with a 'standard plug' in accordance with the Plugs and Sockets etc. (Safety) Regulations 1994, Statutory Instrument 1994 No. 1768, unless exempted by those regulations.</p> <p>NOTE "Standard plug" is defined in SI 1768:1994 and essentially means an approved plug conforming to BS 1363 or an approved conversion plug.</p>		N/A
G.7.1	<p>Ireland</p> <p>To the first paragraph the following is added:</p> <p>Apparatus which is fitted with a flexible cable or cord shall be provided with a plug in accordance with Statutory Instrument 525: 1997, "13 A Plugs and Conversion Adapters for Domestic Use Regulations: 1997. S.I. 525 provides for the recognition of a standard of another Member State which is equivalent to the relevant Irish Standard</p>		N/A
G.7.2	<p>Ireland and United Kingdom</p> <p>To the first paragraph the following is added:</p> <p>A power supply cord with a conductor of 1,25 mm² is allowed for equipment which is rated over 10 A and up to and including 13 A.</p>		N/A

IEC 62368-1			
Clause	Requirement + Test	Result - Remark	Verdict
ZC	ANNEX ZC, NATIONAL DEVIATIONS (EN)		
10.5.2	<p>Germany</p> <p>The following requirement applies:</p> <p>For the operation of any cathode ray tube intended for the display of visual images operating at an acceleration voltage exceeding 40 kV, authorization is required, or application of type approval (Bauartzulassung) and marking.</p> <p><i>Justification:</i> German ministerial decree against ionizing radiation (Röntgenverordnung), in force since 2002-07-01, implementing the European Directive 96/29/EURATOM.</p> <p>NOTE Contact address: Physikalisch-Technische Bundesanstalt, Bundesallee 100, D-38116 Braunschweig, Tel.: Int+49-531-592-6320, Internet: http://www.ptb.de</p>		N/A

IEC 62368-1			
Clause	Requirement + Test	Result - Remark	Verdict

ZD	IEC and CENELEC CODE DESIGNATIONS FOR FLEXIBLE CORDS (EN)			N/A
	Type of flexible cord		Code designations	
		IEC	CENELEC	
	PVC insulated cords			
	Flat twin tinsel cord	60227 IEC 41	H03VH-Y	
	Light polyvinyl chloride sheathed flexible cord	60227 IEC 52	H03VV-F H03VVH2-F	
	Ordinary polyvinyl chloride sheathed flexible cord	60227 IEC 53	H05VV-F H05VVH2-F	
	Rubber insulated cords			
	Braided cord	60245 IEC 51	H03RT-F	
	Ordinary tough rubber sheathed flexible cord	60245 IEC 53	H05RR-F	
	Ordinary polychloroprene sheathed flexible cord	60245 IEC 57	H05RN-F	
	Heavy polychloroprene sheathed flexible cord	60245 IEC 66	H07RN-F	
	Cords having high flexibility			
	Rubber insulated and sheathed cord	60245 IEC 86	H03RR-H	
	Rubber insulated, crosslinked PVC sheathed cord	60245 IEC 87	H03RV4-H	
	Crosslinked PVC insulated and sheathed cord	60245 IEC 88	H03V4V4-H	
	Cords insulated and sheathed with halogen-free thermoplastic compounds			
	Light halogen-free thermoplastic insulated and sheathed flexible cords		H03Z1Z1-F H03Z1Z1H2-F	
	Ordinary halogen-free thermoplastic insulated and sheathed flexible cords		H05Z1Z1-F H05Z1Z1H2-F	

---End of Attachment 2---

IEC 62368_1E ATTACHMENT			
Clause	Requirement + Test	Result - Remark	Verdict
ATTACHMENT TO TEST REPORT			
IEC 62368-1 (AUSTRALIA / NEW ZEALAND) NATIONAL DIFFERENCES (Audio/video, information and communication technology equipment)			
Differences according to : AS/NZS 62368.1:2022			
TRF template used:: IECEE OD-2020-F3, Ed. 1.1			
Attachment Form No. : AU_NZ_ND_IEC62368_1E			
Attachment Originator : JAS-ANZ			
Master Attachment : 2022-07-01			
Copyright © 2020 IEC System for Conformity Testing and Certification of Electrical Equipment (IECEE), Geneva, Switzerland. All rights reserved.			
	National Differences		P
Appendix ZZ	Variations to IEC 62368-1:2018 (ED. 3.0) for Australia and New Zealand		P
ZZ1 Scope	This Appendix lists the normative variations to IEC 62368-1:2018 (ED. 3.0)		P
ZZ2 Variations	The following modifications are required for Australian/New Zealand conditions:		P
2	<p>After the first paragraph, <i>add</i> the following: The Australian or Australian/New Zealand Standards listed below are modified adoptions of, or not equivalent to, the IEC normative references and are required for the application of this Standard. All references in the source text to those IEC normative references shall be replaced by references to the corresponding Australian or Australian/New Zealand Standards. Australian or Australian/New Zealand Standards that are identical adoptions of international normative references may be used interchangeably</p> <ul style="list-style-type: none"> -AS/NZS 3112, <i>Approval and test specification—Plugs and socket-outlets</i> -AS/NZS 3123, <i>Approval and test specification—Plugs, socket-outlets and couplers for general industrial application</i> -AS/NZS 3191, <i>Electric flexible cords</i> -AS/NZS 60884.1, <i>Plugs and socket-outlets for household and similar purposes, Part 1: General requirements</i> -IEC 60086-2 <i>Primary batteries — Part 2: Physical and electrical specifications</i> -AS/NZS 60065, <i>Audio, video and similar electronic apparatus—Safety requirements (IEC 60065:2015 (ED.8.0) MOD)</i> -AS/NZS 60320.1, <i>Appliance couplers for household and similar general purposes,</i> 		P

IEC 62368_1E ATTACHMENT			
Clause	Requirement + Test	Result - Remark	Verdict
	<p><i>Part 1: General requirements (IEC 60320-1, Ed.2.1 (2007) MOD)</i></p> <p><i>-AS/NZS 60320.2.2, Appliance couplers for household and similar general purposes</i></p> <p><i>Part 2.2: Interconnection couplers for household and similar equipment (IEC 60320-2-2, Ed.2.0 (1998) MOD)</i></p> <p><i>-AS/NZS 60695.2.11, Fire hazard testing, Part 2.11: Glowing/hot wire based test methods—Glow-wire flammability test method for end-products</i></p> <p><i>-AS/NZS 60695.11.5, Fire hazard testing, Part 11.5: Test flames—Needle-flame test method—Apparatus, confirmatory test arrangement and guidance</i></p> <p><i>-AS/NZS 60695.11.10, Fire hazard testing, Part 11.10: Test flames—50 W horizontal and vertical flame test methods</i></p> <p><i>-AS/NZS 60884.1, Plugs and socket-outlets for household and similar purposes, Part 1: General requirements</i></p> <p><i>-AS/NZS 60950.1, Information technology equipment—Safety, Part 1: General requirements (IEC 60950-1, Ed.2.2 (2013), MOD)</i></p> <p><i>IEC 61032:1997, Protection of persons and equipment by enclosures—Probes for verification</i></p> <p><i>-AS/NZS 61558.1, Safety of Power Transformers, Power Supplies, Reactors and Similar Products, Part 1: General requirements and tests (IEC 61558-1 Ed 3, MOD)</i></p> <p><i>-AS/NZS 61558.2.16, Safety of transformers, reactors, power supply units and similar products for voltages up to 1 100 V, Part 2.16: Particular requirements and tests for switch mode power supply units and transformers for switch mode power supply units.</i></p>		
4.7.2	<p>Requirements</p> <p><i>Delete the text of the second paragraph and replace with the following:</i></p> <p>Equipment with a plug portion, suitable for insertion into a 10 A 3-pin flat-pin socket-outlet conforming to AS/NZS 3112, shall conform to the requirements in AS/NZS 3112 for equipment with integral pins for insertion into socket-outlets. Conformity is checked by inspection and, if necessary, by the tests in AS/NZS 3112.</p> <p>NOTE: Equipment with plug portions for use in countries other than Australia and New Zealand will need to conform to other countries' requirements</p> <p>Note Additional AS/NZS 3112 Appendix J, TRF is appended to end of this TRF.</p>		N/A
4.7.3	<p>Compliance Criteria</p> <p><i>Delete this clause</i></p>		N/A

IEC 62368_1E ATTACHMENT					
Clause	Requirement + Test		Result - Remark		Verdict
4.8.1	General After second list, <i>add</i> the following: NOTE: Refer to the Consumer Goods (Products Containing Button/Coin Batteries) Safety Standard 2020 and Consumer Goods (Products Containing Button/Coin Batteries) Information Standard 2020 for more information on button cell batteries in Australia..				N/A
5.4.10.2.1	General <i>Delete</i> the first paragraph and <i>replace</i> with the following: In Australia, the separation is checked by the test given in both Clause 5.4.10.2.2 and Clause 5.4.10.2.3. In New Zealand, the separation is checked by the test given in either 5.4.10.2.2 or 5.4.10.2.3..				N/A
Table 28	<i>Delete</i> Table 28 and <i>replace</i> with the following:				N/A
Parts	Impulse test		Steady state test		
	New Zealand	Australia	New Zealand	Australia	
Parts indicated in Clause 5.4.10.1 a) ^a	2.5 kV	7.0 kV for hand-held telephones and headsets, 2.5 kV for other equipment.	1.5 kV	3 kV	
Parts indicated in Clause 5.4.10.1 b) and c) ^b	1.5 kV ^c		1.0 kV	1.5 kV	
^a Surge suppressors shall not be removed. ^b Surge suppressors may be removed, provided that such devices pass the impulse test of Clause 5.4.10.2.2 when tested as components outside the equipment. ^c During this test, it is allowed for a surge suppressor to operate and for a sparkover to occur in a GDT.					
5.4.10.2.2	<i>Delete</i> "NOTE" and <i>replace</i> with "NOTE 1". After NOTE 1, <i>add</i> the following: NOTE 2: For Australia, the 7 kV impulse simulates lightning surges on typical rural and semi-rural network lines. NOTE 3: For Australia, the value of 2.5 kV for Clause 5.4.10.1 a) was chosen to ensure the adequacy of the insulation concerned and does not necessarily simulate likely overvoltages.				N/A
5.4.10.2.3	<i>Delete</i> "NOTE" and <i>replace</i> with "NOTE 1". After NOTE 1, <i>add</i> the following: NOTE 2: For Australia, where there are capacitors across the insulation under test, it is recommended that d.c. test voltages are used. NOTE 3: The 3 kV and 1.5 kV values for Australia have been determined considering the low frequency induced voltages from the power supply distribution system.				N/A
6	Electrically-caused fire				P

IEC 62368_1E ATTACHMENT			
Clause	Requirement + Test	Result - Remark	Verdict
6.6	After Clause 6.6, <i>add</i> the new Clauses 6.201 as follows: 6.201 External power supplies, docking stations and other similar devices (see special national conditions)		P
8.6	Stability of equipment		N/A
Table 36	Footnote ^a , after first sentence, <i>add</i> the following: Equipment having displays with moving images shall include "television sets and display devices".		N/A
8.6.1	After Clause 8.6.1 <i>add</i> the following new clauses: 8.6.201 Restraining Device fixing point (see special national conditions) 8.6.202 Restraining device (see special national conditions)		N/A
Annex F Paragraph F.3.3.4	Rated Voltage <i>Delete</i> "NOTE" and <i>replace</i> with NOTE1" After NOTE 1, <i>add</i> the following Equipment that is intended for connection to the supply mains in Australia and New Zealand shall be marked with: (a) A rated voltage of: <ul style="list-style-type: none"> • 230 V for single phase equipment • 400 V for poly phase equipment Or (b) A rated voltage range that includes: <ul style="list-style-type: none"> • 230 V for single phase equipment • 400 V for poly phase equipment NOTE 2: equipment that is not rated as above is not suitable for direct connection to the supply mains in Australia or new Zealand.		P
Annex F.3.3.5	After the list, <i>add</i> the following Equipment that is intended for connection to supply mains in Australia or New Zealand shall be marked with a rated frequency of 50 Hz or a rated frequency range or nominal value which includes 50Hz		P
Annex F.3.8	After "The DC output of an external power supply", insert "or docking stations and other similar external devices"		N/A
Annex G Paragraph G.4.2	Mains connectors 1 After "IEC 60320", insert "or AS/NZS 60320 series". 2 After "IEC 60906-1", insert"or AS/NZS 3123" 3 <i>After</i> first paragraph <i>add</i> the following: 10 A or 15 A 250 V flat pin plugs for the connection of equipment to mains-powered socket-outlets for household or similar general use shall comply with AS/NZS 3112 or AS/NZS 60884.1.		P

IEC 62368_1E ATTACHMENT			
Clause	Requirement + Test	Result - Remark	Verdict
Paragraph G.5.3.1	Transformers, General 1 Third dashed point <i>replace</i> 'IEC 61558-1 and the relevant parts of IEC 61558-2' with 'AS/NZS 61558-1 and the relevant parts of AS/NZS 61558.2' 2 Fourth dashed point <i>replace</i> 'IEC 61558-2-16' with 'AS/NZS 61558.2.16'.		N/A
Annex G.7.1	Mains supply cords, General Fourth dashed paragraph, <i>replace</i> 'IEC 60320-1' with 'AS/NZS 60320.1'		N/A
Table G.7	Sizes of conductors 1 First column, second row, <i>delete</i> "6" and <i>replace</i> with "7.5" 2 Second column, second row, <i>delete</i> '0,75' and <i>replace</i> with '0.75 ^b 3 <i>Delete</i> NOTE 1. 4 <i>Replace</i> 'NOTE 2' with 'NOTE:'. 5 <i>Delete</i> 'Footnote b' and <i>replace</i> with the following: ^b This nominal cross-sectional area is only allowed for Class II appliances if the length of the power supply cord, measured between the point where the cord, or cord guard, enters the appliance, and the entry to the plug does not exceed 2 m (0.5 mm ² three-core supply flexible cords are not permitted; see AS/NZS 3191). 6 Footnote c <i>replace</i> 'IEC 60320-1' with 'AS/NZS 60320.1' 7 Footnote d <i>replace</i> 'IEC 60320-1' with 'AS/NZS 60320.1'		N/A
Annex M M 2.1	<i>Add</i> "IEC 60086-2" to the list		N/A
Annex M Paragraph M.3.2	Test method Delete "NOTE" and replace with "NOTE 1" After NOTE 1 <i>add</i> the following: NOTE 2: In cases where the voltage source is provided by power from an unassociated power source, consideration should be given to the effects of possible single fault conditions in the unassociated equipment. If the power source is unknown then it should be assumed that the maximum limit of ES1 may be applied to the source input under assumed single fault conditions in the source when assessing the charging circuit in the equipment under test.		N/A
	Special national conditions (if any)		P

IEC 62368_1E ATTACHMENT			
Clause	Requirement + Test	Result - Remark	Verdict
6.201	<p>External power supplies, docking stations and other similar devices</p> <p>For external power supplies, docking stations and other similar devices, during and after abnormal operating conditions and during single fault conditions the output voltage—</p> <ul style="list-style-type: none"> (a) at all ES1 outlets or connectors shall not increase by more than 10 % of the output rated voltage under normal operating conditions, measured after 3 s of introducing a single fault condition and after 3 s of introducing abnormal operating conditions; and (b) of a USB outlet or connector shall not increase by more than 3 V or 10 % of the output rated voltage under normal operating conditions, whichever is higher, measured after 3 seconds of introducing a single fault condition and after 3 s of introducing abnormal operating conditions <p>For equipment with multiple rated voltages at the output, the requirements apply with the equipment configured for each output rated voltage in turn</p> <p>NOTE: This is intended to reduce the possibility of battery fire or explosion in attached equipment or accessories when charging secondary lithium batteries. The 3 s measurement delay is based on IEC document 108/742/INF, <i>TC 108, Standards Interpretation Panel Question 15 — Output voltage</i>, in relation to similar requirements in IEC 62368-3:2017.</p> <p>Conformity shall be checked by measurement, taking into account the abnormal operating conditions of Annex B.3 and the simulated single fault conditions of Annex B.4.</p>		P
8.6.201	<p>Restraining device fixing point</p> <p>Freestanding-capable MS2 and MS3 television sets and display devices shall be provided with a fixing point to facilitate the anchoring of the equipment from toppling</p> <p>The fixing point shall conform to Clause 8.7 where the fixing point uses a wall, ceiling or other structure mount. Alternatively, the fixing point shall be capable of withstanding a pull equal to the mass of the equipment in all directions without damage</p> <p>Instructions for installation or instructions for use shall be provided to specify correct use of the fixing point</p>		N/A

IEC 62368_1E ATTACHMENT			
Clause	Requirement + Test	Result - Remark	Verdict
8.6.202	<p>Restraining device MS2 and MS3 television sets and display devices shall be provided with a restraining device and associated hardware to attach to the television set or display device.</p> <p>The restraining device shall be capable of withstanding a pull equal to the mass of the equipment in all directions.</p> <p>Instructions for installation or instructions for use shall be provided to specify correct use of the fixing point</p>		N/A

AS/NZS 3112:2017 Appendix J			
Clause	Requirement + Test	Result - Remark	Verdict
<p>ATTACHMENT TO TEST REPORT AS_NZS_3112:2017_+A1:2021 Appendix J AUSTRALIAN / NEW ZEALAND NATIONAL DIFFERENCES (Approval and test specification—Plugs and socket-outlets)</p>			
Differences according to : AS_NZS_3112:2017_Amendment 1:2021_Appendix J			
TRF template used: : IECCE OD-2020-F3, Ed. 1.1			
Attachment Form No. : AS_NZS_3112:2017_Appendix J			
Attachment Originator : JAS-ANZ			
Master Attachment..... : 2022-06			
Copyright © 2020 IEC System for Conformity Testing and Certification of Electrical Equipment (IECEE), Geneva, Switzerland. All rights reserved.			
	<p>Note: AS/NZS 3112 is NOT covered by IECEE Accreditation for Testing / Reporting Please State Laboratory Accreditation for this Standard</p>		N/A
	Accreditation		N/A
	Accreditation Stamp		N/A

<p>J1 SCOPE</p>	<p>General: This Appendix specifies additional dimensional and constructional requirements for detachable plug portions, or equipment incorporating integral supply pins or equipment incorporating detachable plug portions.</p> <p>This Appendix shall be read in conjunction with Section 2 of this Standard.</p> <p>For the purposes of this Appendix, where the term 'plug' is used in Section 2 it shall be taken to mean the plug portion of equipment or the detachable plug portion.</p> <p>The equipment shall comply with the relevant product Standard. The tests and requirements specified in this Appendix are in addition to any test and requirements of the relevant product Standard for the equipment. (AS/NZS 3112:2017/A1:2021)</p>	<p>N/A</p>
---------------------	---	------------

J2	DEFINITION	N/A
<p>J2.1</p>	<p>Detachable plug portion A plug portion that is detachable from the equipment and with connections including the following standardized outputs and other contacts</p> <p>(a) Type A (see Figure J1): A detachable plug portion with a connection intended for plugging directly into equipment. The connection being via the equipment group 1 appliance inlet within the scope of AS/NZS 60320.1.</p> <p>(b) Type B (see Figure J2): A detachable plug portion with a non-standardized connection intended for plugging directly into equipment</p> <p>(c) Type C (see Figure J3): A detachable plug portion with a connection intended for use with an adaptor connected to a flexible cord so as to replicate a supply plug and flexible cord configuration. The connection being via a group 1 appliance outlet within scope of AS/NZS 60320.2.2, which is integral with the plug portion (AS/NZS 3112:2017)</p>	<p>N/A</p>
<p>J2.2</p>	<p>Integral plug portion A plug portion that is integral to the equipment enclosure and is not detachable (AS/NZS 3112:2017)</p>	<p>N/A</p>
<p>J2.3</p>	<p>Plug portion A plug portion is that portion of equipment with pins for insertion into a socket-outlet, including the plug pins, terminals of the plug pins, external dimensions of the 'maximum projection' and any connections of a detachable plug portion. (AS/NZS 3112:2017/A1:2021)</p>	<p>N/A</p>

<p>J3</p>	<p>REQUIREMENTS FOR THE PLUG PORTION</p>	<p>N/A</p>
-----------	---	------------

<p>J3.1</p>	<p>General</p>	<p>N/A</p>
-------------	----------------	------------

	The following provisions apply to the dimensional and constructional requirements of plug portions of equipment and any detachable connection between the plug portion and the equipment:		
(a)	For detachable plug portions intended for connection to the equipment in multiple orientations, the relevant tests are performed in the most onerous orientation.		N/A
(b)	For Type A detachable plug portion, the relevant requirements of AS/NZS 3105:2014 are applicable, in addition to conformance with relevant clauses of this Appendix		N/A
(c)	For Type B detachable plug portions, the conformance is shown by the relevant clauses of this Appendix.		N/A
(d)	For Type C detachable plug portions, conformance is shown by assessment to Section 2 of this Standard (plugs) and relevant clauses of this Appendix (AS/NZS 3112:2017)		N/A

J3.2	Plug pins of plug portions The requirements of Clause 2.2 are applicable for plug pins.		N/A
------	---	--	-----

2.2	PLUG PINS		N/A
2.2.1	Current carrying parts of plug pins of metal having sufficient mechanical strength, electrical conductivity and resistance to corrosion adequate for the intended use		N/A
	Plug pin material?		

2.2.3	Plug pins adequately proportioned throughout and portion adjacent to the connection designed to not introduce a stress concentration which may lead to a fracture of the pin, and suitably shaped to prevent abrasion or cutting of conductor strands due to flexure in normal use		N/A
	Exposed ends of plug pins have a lead-in, bevel or radius to facilitate entry into socket-outlets and to operate shutters		N/A
	Flat-pins with the following profile are deemed to comply:		
(a)	Flat-pins with a radius on the end with side bevels may have a width and thickness profile as specified in Figure 2.1(h)		N/A

(b)	Flat-pins square on the end with corner and side bevels may have a width and thickness profile as specified in Figure 2.1(i)		N/A
(c)	Flat-pins square on the end with corner bevels and a radius on the sides may have a width and thickness profile as specified in Figure 2.1(j)		N/A
	Contact portion of the pins smooth and free from openings or indentations		N/A
	Flat pin plugs having a longitudinal seam or opening in the contact portion of one face; width not exceeding 0.3 mm and		N/A
	Thickness not exceeding 1.58 mm		N/A
	Exposed portion of earthing pins and pins other than insulated pins free from any non-metallic coverings or coatings (AS/NZS 3112:2017)		N/A
2.2.4	Live parts of insulated pin plugs not exposed when plug is partially or fully engaged with associated socket		N/A
	Compliance by measurement to Figure 2.4	(see appended table)	N/A
	Lacquer, enamel or sprayed insulating coating not considered to be insulation material		N/A
	All live pins on low voltage plugs except for those shown in Figure 2.1 (a2), (b) and (g) of the insulated pin type		N/A
	Colour green or green / yellow not used for insulation of insulated pins (AS/NZS 3112:2017)		N/A

J3.3	Ratings and dimensions for low-voltage plug portions Requirements of clauses 2.8.1 and 2.8.4 apply for rating and dimensions		N/A
------	--	--	-----

2.8	Ratings and Dimensions of Low Voltage Plugs		
2.8.1	Plugs with ratings up to and including 20A; shall conform to the appropriate dimensions shown in Figure 2.1	(see appended results)	N/A
	Rating of plug	___A	
	Nominal dimensions covering disposition of pins checked by gauge of Appendix A		N/A
	Distance between live pin and edge of moulding to not less than 9 mm		N/A
	Measured distance	___mm	

	No point on plug face protrudes more than 0.5 mm		N/A
	Measured protrusion	___mm	
	Dimensional requirements of Figure 2.1(e2) did not applied to plugs with greater than three pins (AS/NZS 3112:2017)		N/A
2.8.4	Low voltage plugs comply with dimensions of Figure 2.1	(see appended table 2.8.1)	N/A
	Disposition of pins checked by gauge complying with Appendix A, B or F as appropriate		N/A
	Low voltage plug having rating up to 15A and of the Figure 2.1 (a1), (c), (d), (f) or (g) type; comply with dimensional requirements of Figure 2.1 (e1 and e2)		N/A
	20A plug of Figure 2.1 (a2) type complies with dimensional requirements of Figure 2.1 (e2)		N/A
	Plugs with insulated pins need not comply with dimension $R20.0 \pm 1$ mm requirement of Figure 2.1 (e3) provided there is at least 9mm from the edge of the live pins to the edge of the plug face Figure 2.1(e3). (AS/NZS 3112:2017)		N/A

J3.4	Internal connections for plug portions Requirements of clause 2.9 apply for internal connections, unless requirements contained in the relevant product standard (AS/NZS 3112:2017)		N/A
------	---	--	-----

2.9	INTERNAL CONNECTIONS		N/A
	Plug provided with earthing connections designed and constructed so that when plug is correctly wired and assembled:		N/A
(a)	Loose terminal screw or conductive material cannot bridge any live or earthed parts		N/A
(b)	Earthing parts effectively isolated from contact with live conductor which may become detached		N/A
(c)	Live parts effectively isolated from contact with any earthing conductor which may become detached		N/A
	Any connections for auxiliary devices comply with above requirements (AS/NZS 3112:2017)		N/A

J3.5	Arrangement of earthing connections for plug portions Requirements of clause 2.10 apply for arrangement of earthing connections		N/A
------	--	--	-----

2.10	Arrangement of earthing connections	N/A
	Earthing pin radial to the circle embracing the pins (AS/NZS 3112:2017)	N/A

J3.6	Configuration of plug portions Requirements of clause 2.12.6 apply for configuration of the plug portion (AS/NZS 3112:2017)	N/A
------	--	-----

2.12	Marking	
2.12.6	Configuration of plugs	N/A
	Pins disposed so that configuration, as viewed from the pins, is earth, neutral and active in a clockwise direction	N/A
	Where there is no earthing pin; live pins conform to this configuration (AS/NZS 3112:2017)	N/A

J4	Tests	N/A
----	--------------	-----

J4.1	<p>General</p> <p>Plug portions of equipment shall be subjected to the following tests and unless stated otherwise, shall comply with the requirements specified in Section 2 for each test. The number of test samples shall be in accordance with Table J1</p> <p>For equipment with a detachable plug portion, the assessment(s) of Table J1 tests 2, 3, 5, 10 and 11 shall be conducted on the—</p> <p>(a) assembled equipment with the detachable plug portion connected; and</p> <p>(b) the detachable plug portion after it has been separated from the equipment</p> <p>(AS/NZS 3112:2017/A1:2021)</p>	N/A
------	--	-----

J4.2	<p>High voltage test</p> <p>The requirements of Clause 2.13.3 are applicable unless requirements are contained in the relevant product standard</p> <p>(AS/NZS 3112:2017)</p>	N/A
------	--	-----

2.13.3	Test No.1 - High voltage test	N/A
--------	-------------------------------	-----

	Plug withstands without failure electric strength test as specified (AS/NZS 3112:2017)	(see appended table)	N/A
--	--	----------------------	-----

J4.3	Mechanical strength		N/A
J4.3.1	<p>Tumbling barrel test</p> <p>The tumbling barrel test is applied to determine the mechanical strength of the plug portions and equipment having integral or detachable plug portions.</p> <p>For equipment with a detachable plug portion, the detachable plug portion may become detached during the test. If this occurs the detachable plug portion shall be reassembled with the equipment when the pins are straightened as per (a) and (b) below.</p> <p>Three samples (Samples BCD in Table J1) that have not been subjected to any previous test are tested as specified in Clause 2.13.7.1, however the test is modified as follows:</p>		N/A
	<p>They are tested in a tumbling barrel as described in AS 60068.2.32 or test Free fall repeated – Procedure 2 in IEC 60068-2.31.</p> <p>The samples shall be dropped from a height of 500 mm onto a steel plate, 3 mm thick.</p> <p>The barrel shall be turned at a rate of 5 r/min, to yield 10 falls per minute. Only one sample shall be tested at a time.</p> <p>A sample is dropped—</p> <p>(a) 500 times if the mass of the specimen does not exceed 250 g.</p> <p>The pins being straightened after each 100 drops and at the completion of the test to pass through the appropriate gauge of Figure A1, Figure B1 or Figure F1; and</p> <p>(b) 250 times if the mass of the specimen exceeds 250 g. The pins being straightened after each 25 drops and at the completion of the test to pass through the appropriate gauge of Figures A1, Figure B1 or Figure F1.</p> <p>(AS/NZS 3112:2017/A1:2021)</p>		N/A
	Mass of sample	_____ Grams	N/A
	Number of drops	500 / 250	N/A
	Compliance shall be checked by Paragraph J4.3.3	(See appended table)	N/A

J4.3.2	<p>Test No.3 Impact test.</p> <p>Plug portions and equipment having integral plug portions or detachable plug portions shall withstand lateral impact forces.</p> <p>All samples that were subjected to the tests in Paragraph J4.3.1 (Samples BCD in Table J1) shall be tested as follows:</p>	N/A
--------	--	-----

	(a) The sample shall be positioned at the centre of a steel plate with a thickness of at least 6 mm. Apertures in the steel plate for the plug pins to pass through shall conform to the corresponding socket Standard. The sample shall be held against the steel plate by clamping all the pins.		N/A
	(b) Samples shall be subjected to blows, with an impact energy of 1.0 ± 0.05 J by any means having the same performance as the spring-operated impact-test apparatus of AS/NZS 3100.		N/A
	(c) Three blows shall be applied to every point that is most likely to directly or indirectly stress the enclosure joints of the sample		N/A
	Compliance shall be checked by Paragraph J4.3.3		N/A

J4.3.3	Specific compliance criteria This Paragraph provides the common compliance assessment criteria for tests specified in Paragraphs J4.3.1 and J4.3.2 .		N/A
	Following each test, the samples shall comply with Clause 2.13.7.1		N/A
(a)	assembled equipment with the detachable plug portion connected;		N/A
	After the test, samples show no damage	(See appended table)	N/A
(b)	the detachable plug portion after it has been separated from the equipment.		N/A
	After the test, samples show no damage	(See appended table)	N/A

4.3.4	Pin bending test The pins of the plug portion of three samples (Samples EFG in Table J1) not subjected to any previous tests shall be tested for compliance with the pin bending test of Clause 2.13.7.2 (AS/NZS 3112:2017/A1:2021)		N/A
-------	--	--	-----

2.13.7.2	Test No.4 – Pin bending test		N/A
	All flat-pin plugs rated up to and including 15 A shall be subjected to the pin bending test		N/A
	Three samples are subjected by clamping the plug in a rigid holding block and applying the bending force as specified		N/A
	After the test the pins shall not be broken off. (AS/NZS 3112:2017)		N/A

J4.8.3	Test No.5 Plug portion detachment requirements		N/A
	For all Type B or C devices and for Type A devices where the outlet of the detachable plug portion is parallel to the plug supply pins, disengagement of the detachable plug portion from the equipment shall require at least two simultaneous independent actions or the use of a tool.		N/A
	The plug portion and the equipment/adaptor shall be connected and disconnected 50 times (100 strokes).		N/A
	Compliance is verified by the plugging test, a force which, over a period of 10 s, shall be increased steadily to 60 ±0.6 N and held at this value for a further 10 s, shall be applied evenly at the connecting equipment in a direction parallel to the pins. This procedure shall be conducted three times on the same plug portion, at intervals of 5 min, without disturbing the plug portions between tests		N/A
	During the test the plug portion shall not separate		N/A
	The test of AS/NZS 3112 'temperature rise test' for plugs shall be conducted immediately after the above test without disturbing the sample. Test No 6 Temperature Rise test J4.4 (AS/NZS 3112:2017/A1:2021)		N/A

J4.4	Temperature rise test The relevant requirements of Clause 2.13.8 are applicable for the temperature rise test, except that the test current shall be that specified in the relevant product standard		N/A
	The temperature rise of the pins shall not exceed 45 K irrespective of the temperature rise of parts specified in end-product standards.		N/A
	For detachable plug portions the temperature rise of terminals and contacts shall not exceed 45 K. (AS/NZS 3112:2017)		N/A

2.13.8	Test No.6 – Temperature rise test		N/A
	Plug tested in draught free environment as specified using clamping units as specified in Figure 2.10		N/A

	Test Current Relevant Product Standard	_____ Amps _____ (Standard?)	N/A
	Temperature of terminals and contacts of detachable plug portion not exceeding 45 K (AS/NZS 3112:2017)	(see appended table)	N/A

J4.5	Securement of pins of the plug portion The requirements of Clause 2.13.9 are applicable for the securement of pins. (AS/NZS 3112:2017)	N/A
------	---	-----

2.13.9	Test No.7. Securement of pins		N/A
2.13.9.1	Movement of pins		N/A
	Plug pins clamped 5 ± 0.5 mm from pin face; test equipment and sample pre-conditioning for 1 h at $40 \pm 1^\circ\text{C}$		N/A
	Force of 18 ± 1 N applied to pin 14 ± 0.5 mm from plug face; applied gradually over 10 s and maintained for 10 s; applied in four directions		N/A
	Maximum deflection during test not exceeding 2.0 mm	(see appended results)	N/A
	Any distortion 5 minutes after test does not prevent insertion of plug into standard gauge(s) (AS/NZS 3112:2017 + A1:2021)		N/A
2.13.9.2	Fixing of pins		N/A
	Plug heated to $50 \pm 2^\circ\text{C}$ for 1h		N/A
	Force of 60 ± 0.6 N applied to each pin over 10 s and maintained for 10 minutes; applied in two directions along length of pin		N/A
	Maximum displacement during test not exceeding 2.4 mm		N/A
	Maximum measured displacement		
	Pin returns to within 0.8 mm of nominal length within 5 minutes of removal of test force (AS/NZS 3112:2017)		N/A

J4.6	Tests on the insulation material of insulated pin-plug portions The requirements of Clause 2.13.13 are applicable for insulating material of insulated plug pins. (AS/NZS 3112:2017)	N/A
------	---	-----

2.13.13	Test No.8 Tests for insulation material of insulated pin plugs		N/A
2.13.13.1	Material of pin-insulation resistant to stresses at temperature likely to occur		N/A
2.13.13.2	Pressure test at high temperature		N/A
	Specimen tested as per Figure 2.5 with force of 2.5 N applied as specified; maintained for 2 h at $160 \pm 5^\circ\text{C}$; removed and cooled by immersion in water within 10 s		N/A
	Thickness of insulation at point of impression not reduced by more than 50%		N/A
	Initial thickness	mm	
	Thickness after test	mm	
	No visible cracks on insulation material		N/A
	Dimension of insulating material not below minimum size in Figure 2.4 (AS/NZS 3112:2017)		N/A

2.13.13.3	Static damp heat test		N/A
	Specimen subjected to two damp heat cycles in accordance with IEC 60068-2-30; Db (12 + 12h), 95% RH, $25 \pm 3^\circ\text{C}$; 40°C		N/A
	After this treatment and recovery to room temperature; specimen subjected to:		N/A
(a)	Insulation resistance test in accordance with clause 2.13.2 (e)	(see appended table)	N/A
(b)	High voltage test in accordance with clause 2.13.3	(see appended table)	N/A
(c)	Abrasion test in accordance with clause 2.13.13.6		N/A
2.13.13.4	Low temperature test		N/A
	Plug maintained at $-15 \pm 2^\circ\text{C}$ for minimum of 24 h and returned to room temperature; after which specimen subjected to:		N/A
(a)	Insulation resistance test in accordance with clause 2.13.2 (e)	(see appended table)	N/A
(b)	High voltage test in accordance with clause 2.13.3	(see appended table)	N/A
(c)	Abrasion test in accordance with clause 2.13.13.6		N/A
2.13.13.5	Impact test at low temperature		N/A
	Specimen maintained at $-15 \pm 2^\circ\text{C}$ for 24 h		N/A
	Specimen placed in position and subjected to impact test as per Figure 2.6; mass of 100 ± 1 g falling through 100 mm		N/A

	Four impacts applied; specimen rotated through 90° between impacts		N/A
	After return to room temperature; no visible cracks of insulating material		N/A
2.13.13.6	Abrasion test		N/A
	Plug held in clamp and tested as per Figure 2.7; pin loaded at 4 N; 20 000 movements		N/A
	After test; pins show no damage affecting safety or impairing further use of the plug		N/A
	Insulating sleeve not punctured or rucked up (AS/NZS 3112:2017)		N/A

J4.7	Test no.9 Equipment with a plug portion intended to be supported by the contacts of a socket-outlet		N/A
	Equipment with pins intended to be introduced into fixed socket-outlets not imposing undue strain on socket-outlet		N/A
	Applied torque not exceeding 0.25 Nm		N/A
	Measured torque (AS/NZS 3112:2017)	____ Nm	

J4.8	Additional requirements for detachable plug portions		N/A
J4.8.1	Test no.10 Access to live parts		N/A
	Small test finger of Figure 13 of IEC 61032 was not possible to contact live parts with the force of 20N		N/A
	incorrectly assemble the plug portion was not possible (AS/NZS 3112:2017)		N/A

J4.8.2	Test No.11 Construction of detachable contacts where the input current of the equipment exceeds 0.2 A		N/A
	Contacts of the equipment shall be such that they make and maintain, under normal service conditions, satisfactory electrical and mechanical contact with the corresponding contact of the detachable plug portion.		N/A
	For connections intended to accommodate pins, contact shall be made on two surfaces diametrically opposite, except if a single spring-assisted contact is used. (AS/NZS 3112:2017/A1:2021)		N/A
	Contacts shall not rely exclusively on the resilience of the contact material and shall have an opposite face of material other than thermoplastic or resilient		N/A

	insulating material. (AS/NZS 3112:2017/ A1:2021)		
	The alignment and contact-making properties of contacts shall be independent of terminal screws		N/A
	The effectiveness of the contacts shall be independent of pressure from any thermoplastic or resilient moulding.		N/A
	A visual inspection is conducted to determine the existence of interference between the metal contacts and the thermoplastic or resilient moulding to provide supplementary contact pressure to the metal contacts.		N/A
	Conformance of the effectiveness of the contacts is checked by inspection and by the inspection and tests in J4.8.3 (AS/NZS 3112:2017)		N/A

J4.8.4	Resistance of insulating material to heat and fire		N/A
J4.8.4.1	Test no.12 Resistance to heat For Type B detachable plug portions parts of non-metallic material, parts of insulating material supporting live parts including connections, and parts of thermoplastic material providing supplementary insulation or reinforced insulation, shall be sufficiently resistant to heat if their deterioration could cause the appliance to fail to comply with this Standard.		N/A
	Ball pressure test conducted in accordance with IEC 60695-10-2		N/A
(a)	75°C ± 2°C, for external parts;		N/A
(b)	125°C ± 2°C, for parts supporting live parts.		N/A

J4.8.4.2	Test no.13 Resistance to fire		N/A
	Plug portions comply with resistance to fire requirements of AS/NZS 3100 Annex A as follows:		N/A
	The glow wire test temperature 'T' for 'retaining parts' of fixed socket outlets shall be 750 C (AS/NZS 3112:2017)		N/A

TABLES OF RESULTS

2.2.4	TABLE: Dimensions of insulation on insulated pin plugs		N/A
Dimension (Figure 2.1 designation)	Measured (mm)	Allowed (mm)	

Phase pin		8.7 ± 0.5
Neutral pin		8.7 ± 0.5

2.8.1	TABLE: Dimensions of plugs- 10A (a1)		N/A
Dimension (Figure 2.1 designation)		Measured (mm)	Allowed (mm)
Phase and neutral pin width (A)			6.35 ± 0.15
Earth pin width (B)			6.35 ± 0.15
Pin thickness (C)			1.63 + 0.15, -0.05
Pin disposition (D)			checked by test gauge
Pin disposition (E)			checked by test gauge
Phase and neutral pin length (F)			17.06 ± 0.4
Earth pin length (G)			19.94 ± 0.8
Pin boss radius - maximum			21.0 max
Pin boss height			8.6 min

2.8.1	TABLE: Dimensions of plugs- 15A (a1)		N/A
Dimension (Figure 2.1 designation)		Measured (mm)	Allowed (mm)
Phase and neutral pin width (A)			6.35 ± 0.15
Earth pin width (B)			9.08 ± 0.15
Pin thickness (C)			1.63 + 0.15, -0.05
Pin disposition (D)			checked by test gauge
Pin disposition (E)			checked by test gauge
Phase and neutral pin length (F)			17.06 ± 0.4
Earth pin length (G)			19.94 ± 0.8
Pin boss radius - maximum			21.0 max
Pin boss height			8.6 min

2.8.1	TABLE: Dimensions of plugs-20A (a2)		N/A
Dimension (Figure 2.1 designation)		Measured (mm)	Allowed (mm)
Phase and neutral pin width (A)			9.08 ± 0.15
Earth pin width (B)			9.08 ± 0.15
Pin thickness (C)			1.63 + 0.15, -0.05
Pin disposition (D)			checked by test gauge
Pin disposition (E)			checked by test gauge
Phase and neutral pin length (F)			17.06 ± 0.4
Earth pin length (G)			19.94 ± 0.8
Pin boss radius - maximum			21.0 max

Pin boss height		8.6 min
-----------------	--	---------

2.8.1	TABLE: Projection from plug face centroid	N/A	
Direction of projection		Measured (mm)	Allowed (mm)
Left			≤ 21.9 or ≥ 27.0
Right			≤ 21.9 or ≥ 27.0
Up			≤ 21.9 or ≥ 27.0
Down			≤ 21.9 or ≥ 27.0

2.13.3	TABLE: Test No. 1 – High voltage test	N/A	
Test voltage applied between:		Test voltage (V)	Breakdown
All poles of the plug; taken in pairs		1000	Yes / No
Live poles of the plug and any external metal		3500	Yes / No
Live poles of the plug and the earthing terminal		1000	Yes / No
Live poles of the plug and a flexible electrode		3500	Yes / No
Live poles and metal foil applied around insulation on pins		1250	Yes / No

2.13.7.1	Test No.2 – Tumbling barrel test	N/A	
	Following the test, the samples shall comply with Clause 2.13.7.1(a..e)	N/A	
	(a) Live parts shall not have become exposed to the standard test finger		N/A
	(b) For earth pins, the resistance of the plug/socket-outlet circuit shall be such that conformance with Clause 3.14.7 is maintained. AS/NZS 3100 Cl 8.5 The resistance shall not exceed 0.1 Ω	___ Ω .	N/A
	(c) Any other function affecting safety shall not be impaired		N/A
	(d) No live part shall have become detached or loosened, to the extent that a hazardous situation is created (see Clause 2.9)		N/A
	(e) The pins shall be inspected with normal, or corrected to normal, vision. Insulation may be removed if necessary. Pins shall not be broken or show cracking		N/A

	Test No.3 Impact test for assembled equipment with the detachable plug portion connected and for equipment with an integral plug portion.		N/A
	Following the test, the samples shall comply with Clause 2.13.7.1 (a..e) as follows:		N/A
	(a) Live parts shall not have become exposed to the standard test finger (Figure 8.10 in AS/NZS 3100 or Test Probe B in IEC 61032)		N/A
	(b) For earth pins, the resistance of the plug/socket-outlet circuit shall be such that conformance with Clause 3.14.7 is maintained so that the resistance between the earthing terminal of any socket-outlet provided with an earthing contact and the earthing terminal of the plug used for testing shall be of a low resistance. Compliance is by the test of earthing connection in AS/NZS 3100 Clause 8.5. The resistance shall not exceed 0.1 Ω	___ Ω .	N/A
	(c) Any other function affecting safety shall not be impaired		N/A
	(d) No live part shall have become detached or loosened, to the extent that a hazardous situation is created		N/A
	(e) The pins shall be inspected with normal, or corrected to normal, vision. Insulation may be removed if necessary. Pins shall not be broken or show cracking.		N/A
	Following the test, the samples shall conform to the 'Guarding of live parts' requirements of AS/NZS 3100:2015 cl 5.1 as follows:		N/A
	Except for equipment intended for use only in a position not accessible to unauthorized persons, all equipment shall be so designed and constructed that, when the equipment is standing, supported, or fixed, in a normal manner, no person can inadvertently come into contact with any live part		N/A
	If a hole giving access to preset controls is marked as such on the enclosure or reference made to it in the instructions and the setting of this control requires a screwdriver or other tool, the adjustment of the control shall not allow contact with any live parts. A metal test pin having a diameter of 2 mm and a length of 100 mm shall not become live when it is inserted through the hole in every position with a force of 10 N.		N/A

	In addition, the opening or removal of any cover or component, with or without tools, where such opening or removal is necessary as a normal operation of the equipment as distinct from maintenance, repairs, or adjustment, shall not expose live parts to inadvertent personal contact.		N/A
	Any metal cover or casing enclosing live parts shall be of a strength sufficient to ensure that it cannot be deformed readily so as to come into contact with live parts.		N/A
	Compliance is checked by inspection, test and checking that live parts shall not have become exposed to the standard test finger (Figure 8.10 in AS/NZS 3100 or Test Probe B in IEC 61032)		N/A
	Class II equipment and class II constructions shall be constructed and enclosed so that there is adequate protection against accidental contact with basic insulation and metal parts separated from live parts by basic insulation only.		P
	It shall only be possible to touch parts which are separated from live parts by double insulation or reinforced insulation.		N/A
	Compliance is checked by application of the standard test finger (Figure 8.10 in AS/NZS 3100 or Test Probe B in IEC 61032)		N/A
	Following the test, the samples shall conform to the 'Separation of live parts from non-current-carrying conductive parts' requirements of AS/NZS 3100.CI 5.2.2 as follows:		N/A
	The support and insulation of every live part shall be such as will ensure that no live part can make contact with any non-current-carrying conductive part exposed to personal contact.		N/A
	In respect of terminals of components such as switches, adequate clearances shall be maintained or insulation shall be provided to prevent contact of the terminals, or loose strands of flexible cords intended to be terminated therein, with exposed conductive parts. Where necessary, provision shall be made to ensure that conductors protruding through terminals, when normally connected, will not contact exposed conductive parts.		N/A
	Compliance is checked by inspection.		N/A

	Test No.3 Impact test for the detachable plug portion after it has been separated from the equipment		N/A
	Following the test, the samples shall comply with Clause 2.13.7.1 (a..e)		N/A

	(a) Live parts shall not have become exposed to the standard test finger (Figure 8.10 in AS/NZS 3100 or Test Probe B in IEC 61032)		N/A
	(b) For earth pins, the resistance of the plug/socket-outlet circuit shall be such that conformance with Clause 3.14.7 is maintained so that the resistance between the earthing terminal of any socket-outlet provided with an earthing contact and the earthing terminal of the plug used for testing shall be of a low resistance. Compliance is by the test of earthing connection in AS/NZS 3100 Clause 8.5. The resistance shall not exceed 0.1 Ω	___ Ω .	N/A
	(c) Any other function affecting safety shall not be impaired		N/A
	(d) No live part shall have become detached or loosened, to the extent that a hazardous situation is created		N/A
	(e) The pins shall be inspected with normal, or corrected to normal, vision. Insulation may be removed if necessary. Pins shall not be broken or show cracking.		N/A
	Following the test, the samples shall conform to the 'Guarding of live parts' requirements of AS/NZS 3100:2015 cl 5.1 as follows:		N/A
	Except for equipment intended for use only in a position not accessible to unauthorized persons, all equipment shall be so designed and constructed that, when the equipment is standing, supported, or fixed, in a normal manner, no person can inadvertently come into contact with any live part		N/A
	If a hole giving access to preset controls is marked as such on the enclosure or reference made to it in the instructions and the setting of this control requires a screwdriver or other tool, the adjustment of the control shall not allow contact with any live parts. A metal test pin having a diameter of 2 mm and a length of 100 mm shall not become live when it is inserted through the hole in every position with a force of 10 N.		N/A

	In addition, the opening or removal of any cover or component, with or without tools, where such opening or removal is necessary as a normal operation of the equipment as distinct from maintenance, repairs, or adjustment, shall not expose live parts to inadvertent personal contact.		N/A
	Any metal cover or casing enclosing live parts shall be of a strength sufficient to ensure that it cannot be deformed readily so as to come into contact with live parts.		N/A
	Compliance is checked by inspection, test and checking that live parts shall not have become exposed to the standard test finger (Figure 8.10 in AS/NZS 3100 or Test Probe B in IEC 61032)		N/A
	Class II equipment and class II constructions shall be constructed and enclosed so that there is adequate protection against accidental contact with basic insulation and metal parts separated from live parts by basic insulation only.		P
	It shall only be possible to touch parts which are separated from live parts by double insulation or reinforced insulation.		N/A
	Compliance is checked by application of the standard test finger (Figure 8.10 in AS/NZS 3100 or Test Probe B in IEC 61032)		N/A
	Following the test, the samples shall conform to the 'Separation of live parts from non-current-carrying conductive parts' requirements of AS/NZS 3100.CI 5.2.2 as follows:		N/A
	The support and insulation of every live part shall be such as will ensure that no live part can make contact with any non-current-carrying conductive part exposed to personal contact.		N/A
	In respect of terminals of components such as switches, adequate clearances shall be maintained or insulation shall be provided to prevent contact of the terminals, or loose strands of flexible cords intended to be terminated therein, with exposed conductive parts. Where necessary, provision shall be made to ensure that conductors protruding through terminals, when normally connected, will not contact exposed conductive parts.		N/A
	Compliance is checked by inspection.		N/A

2.13.8	TABLE: Test No. 6 - Temperature rise test		N/A
	Ambient temperature	°C	
	Test current	A	
Measured part		dT measured (K)	dT allowed (K)
Active (phase) terminal			45
Neutral terminal			45
Earthing terminal			45

2.13.9.1	TABLE: Movement of pins		N/A
	Earth and neutral pins clamped – phase pin loaded		
Force direction		Measured deflection (mm)	Allowed deflection (mm)
Force towards neutral plane parallel to pin plane			2.0
Force from neutral plane parallel to pin plane			2.0
Force outwards at 90° to pin plane			2.0
Force inwards at 90° to pin plane			2.0

2.13.9.1	TABLE: Movement of pins		N/A
	Phase and neutral pins clamped – earth pin loaded		
Force direction		Measured deflection (mm)	Allowed deflection (mm)
Force inwards parallel to pin plane			2.0
Force outwards parallel to pin plane			2.0
Force towards neutral			2.0
Force towards phase			2.0

2.13.9.1	TABLE: Movement of pins		N/A
	Phase and earth pins clamped – neutral pin loaded		
Force direction		Measured deflection (mm)	Allowed deflection (mm)
Force towards phase plane parallel to pin plane			2.0
Force from phase plane parallel to pin plane			2.0
Force outwards at 90° to pin plane			2.0
Force inwards at 90° to pin plane			2.0

2.13.13.3	TABLE: Test No.13(b) – Insulation resistance test after static damp heat test		N/A
-----------	---	--	-----

Applied between:	Insulation resistance (MΩ)	Minimum required (MΩ)
Live poles and metal foil applied around insulation on pins		5

2.13.13.3	TABLE: Test No.1 – High voltage test after static damp heat test		N/A
Test voltage applied between:	Test voltage (V)	Breakdown	
Live poles and metal foil applied around insulation on pins	1250	Yes / No	

2.13.13.4	TABLE: Test No.1 – Insulation resistance test after low temperature test		N/A
Applied between:	Insulation resistance (MΩ)	Minimum required (MΩ)	
Live poles and metal foil applied around insulation on pins		5	

2.13.13.4	TABLE: Test No.1 – High voltage test after low temperature test		N/A
Test voltage applied between:	Test voltage (V)	Breakdown	
Live poles and metal foil applied around insulation on pins	1250	Yes / No	

J4.8.4.1	TABLE: Test no.12 Resistance to heat		N/A
Component tested	Temperature (°C)	Diameter of impression (mm)	

Conformance is checked by subjecting the relevant part to the ball pressure test of IEC 60695-10-2.

J4.8.4.2	TABLE: Test no.13 Resistance to Fire		N/A
	Plug portions shall comply with the requirements for resistance to fire in accordance with AS/NZS 3100:2017 Annex A. The glow-wire test temperature 'T' shall be 750°C.		N/A

Glow-wire testing was conducted in accordance with IEC 60695-2-11.

Test specimens arranged so that the surface in contact with the tip of the glow-wire was vertical and glow wire tip applied to surface of the specimen likely to be subjected to thermal stresses in normal use.

A layer of white pine board and wrapping tissue was placed beneath the sample at 200mm ± 5mm distance.

Visible flame or sustained glowing								
Visible Flame Duration in Seconds during test.								
Duration of flaming or glowing after tip removal (max. allowable 30 s) (s)								
Surrounding parts burned away completely (not permitted)								
Ignition of wrapping tissue layer (not permitted)								
RESULTS If parts tested withstand the glow-wire test, but during the test produce a flame that persists for longer than 2 s, then the consequential needle flame test of AS/NZS 3100:2017 Annex A 6.1.5 applies.								

- LEGEND:
- CE Complete Equipment
 - SA Sub Assembly
 - SE Self Extinguished
 - EBD Emitted Burning Droplets
 - SBD Specimen Burned and Distorted
 - SMD Specimen Melted and Distorted
 - ME Manually Extinguished
 - SC Separate Component
 - SS Specimen Scorched
 - NA Not Applicable
 - SCC Specimen Completely Consumed
 - WPNI Wall Penetrated but no Ignition
 - NI No Ignition
 - X Flame Appeared for an Instant

TABLE: Needle- flame test (NFT)					N/A
Object/ Part No./ Material	Manufacturer/ trademark	Duration of application of test flame (ta); (s)	Ignition of specified layer Yes/No	Duration of burning (tb) (s)	Verdict

Supplementary information:
 - NFT not relevant (or applicable) for Parts of material classified as V-0 or V-1
 - NFT not relevant (or applicable) for Base material of PCBs classified as V-0 or if relevant VTM-0

	PHOTOGRAPHS	N/A
--	-------------	-----

---End of Attachment 3---

Safety Information

Please read all the safety information carefully before using.

- The device must be connected to an earthed mains socket-outlet.
- Check the input voltage before powering on the device to avoid damage.
- The socket-outlet shall be installed near the device and shall be easily accessible.
- High touch current! Make sure the device is properly grounded before connecting to the power supply.
- For the device with the sign  indicating hazardous live, the external wiring connected to the terminals requires installation by an instructed person.
- This equipment is not suitable for use in locations where children are likely to be present.



WARNING:



1. Do not ingest battery. Chemical Burn Hazard!
 2. This product contains a coin/button cell battery. If the coin/button cell battery is swallowed, it can cause severe internal burns in just 2 hours and can lead to death.
 3. Improper replacement of the battery with an incorrect type may defeat a safeguard (for example, in the case of some lithium battery types).
 4. Do not dispose of the battery into fire or a hot oven, or mechanically crush or cut the battery, which may result in an explosion.
 5. Do not leave the battery in an extremely high temperature surrounding environment, which may result in an explosion or the leakage of flammable liquid or gas.
 6. Do not subject the battery to extremely low air pressure, which may result in an explosion or the leakage of flammable liquid or gas.
 7. Dispose of used batteries according to the instructions.
 8. If you think batteries might have been swallowed or placed inside any part of the body, seek immediate medical attention.
 9. The battery is hazardous and should be kept away from children (whether the battery is new or used).
- Keep body parts away from fan blades. Disconnect the power source during servicing.
 - Proper configuration of all passwords and other security settings is the responsibility of the installer and/or end-user.
 - Never place the device in an unstable location. The device may fall, causing serious personal injury or death.
 - If smoke, odor, or noise arises from the device, immediately turn off the power, unplug the power cable, and contact the service center.
 - Use the device in conjunction with an UPS, and use factory recommended HDD if possible.
 - Do not touch the bare components (such as the metal contacts of the inlets) and wait for at least 5 minutes, since electricity may still exist after the device is powered off.

Preventive and Cautionary Tips

Before connecting and operating your device, please be advised of the following tips:

- The device shall not be exposed to water dripping or splashing, and no objects filled with liquids, such as vases, shall be placed on the device.
- Ensure correct wiring of the terminals for connection to an AC mains supply.
- No naked flame sources, such as lighted candles, should be placed on the device.
- The ventilation should not be impeded by covering the ventilation openings with items, such as newspapers, table-cloths, curtains. The openings shall never be blocked by placing the device on a bed, sofa, rug, or other similar surface.



- For the device with sticker  or , pay attention to the following cautions:
CAUTION: Hot parts! Do not touch. Burned fingers when handling the parts. Wait one-half hour after switching off before handling the parts.
- Ensure the device is properly secured to a rack or shelf. Major shocks or jolts to the device as a result of dropping it may cause damage to the sensitive electronics within the device.
- The USB port of the device is used for connecting to a mouse, keyboard, or USB flash drive only. The current for the connected device shall be not more than 0.1 A.
- If a new device has been placed for more than 6 months, you shall unseal the device package and power on the device to check if your device still can work normally. If exception occurs, please contact after-sales service for help.

- If the device needs to be wired by yourself, select the corresponding wire to supply power according to the electric parameters labeled on the device. Strip off wire with a standard wire stripper at corresponding position. To avoid serious consequences, the length of stripped wire shall be appropriate, and conductors shall not be exposed.
- Make sure that the power has been disconnected before you wire, install, or disassemble the device.
- The device should be placed in a dry environment without corrosive gas (refer to the user manual for details about corrosive gas).
- If your device is installed by spring loaded self-clinching screws, in order to prevent the chassis cover from being removed by non-professional individuals, the tightening torque of chassis cover screws should be 0.45 N.m.

*******End of attachment 4*******