



Walk-Through Metal Detector

User Manual

Legal Information

About this Manual

The Manual includes instructions for using and managing the Product. Pictures, charts, images and all other information hereinafter are for description and explanation only. The information contained in the Manual is subject to change, without notice, due to firmware updates or other reasons. Please find the latest version of this Manual at the Hikvision website (<https://www.hikvision.com/>).

Please use this Manual with the guidance and assistance of professionals trained in supporting the Product.

Trademarks

HIKVISION and other Hikvision's trademarks and logos are the properties of Hikvision in various jurisdictions.

Other trademarks and logos mentioned are the properties of their respective owners.

Disclaimer

TO THE MAXIMUM EXTENT PERMITTED BY APPLICABLE LAW, THIS MANUAL AND THE PRODUCT DESCRIBED, WITH ITS HARDWARE, SOFTWARE AND FIRMWARE, ARE PROVIDED "AS IS" AND "WITH ALL FAULTS AND ERRORS". HIKVISION MAKES NO WARRANTIES, EXPRESS OR IMPLIED, INCLUDING WITHOUT LIMITATION, MERCHANTABILITY, SATISFACTORY QUALITY, OR FITNESS FOR A PARTICULAR PURPOSE. THE USE OF THE PRODUCT BY YOU IS AT YOUR OWN RISK. IN NO EVENT WILL HIKVISION BE LIABLE TO YOU FOR ANY SPECIAL, CONSEQUENTIAL, INCIDENTAL, OR INDIRECT DAMAGES, INCLUDING, AMONG OTHERS, DAMAGES FOR LOSS OF BUSINESS PROFITS, BUSINESS INTERRUPTION, OR LOSS OF DATA, CORRUPTION OF SYSTEMS, OR LOSS OF DOCUMENTATION, WHETHER BASED ON BREACH OF CONTRACT, TORT (INCLUDING NEGLIGENCE), PRODUCT LIABILITY, OR OTHERWISE, IN CONNECTION WITH THE USE OF THE PRODUCT, EVEN IF HIKVISION HAS BEEN ADVISED OF THE POSSIBILITY OF SUCH DAMAGES OR LOSS.



YOU ACKNOWLEDGE THAT THE NATURE OF INTERNET PROVIDES FOR INHERENT SECURITY RISKS, AND HIKVISION SHALL NOT TAKE ANY RESPONSIBILITIES FOR ABNORMAL OPERATION, PRIVACY LEAKAGE OR OTHER DAMAGES RESULTING FROM CYBER-ATTACK, HACKER ATTACK, VIRUS INSPECTION, OR OTHER INTERNET SECURITY RISKS; HOWEVER, HIKVISION WILL PROVIDE TIMELY TECHNICAL SUPPORT IF REQUIRED.

YOU AGREE TO USE THIS PRODUCT IN COMPLIANCE WITH ALL APPLICABLE LAWS, AND YOU ARE SOLELY RESPONSIBLE FOR ENSURING THAT YOUR USE CONFORMS TO THE APPLICABLE LAW. ESPECIALLY, YOU ARE RESPONSIBLE, FOR USING THIS PRODUCT IN A MANNER THAT DOES NOT INFRINGE ON THE RIGHTS OF THIRD PARTIES, INCLUDING WITHOUT LIMITATION, RIGHTS OF PUBLICITY, INTELLECTUAL PROPERTY RIGHTS, OR DATA PROTECTION AND OTHER PRIVACY RIGHTS. YOU SHALL NOT USE THIS PRODUCT FOR ANY PROHIBITED END-USES, INCLUDING THE DEVELOPMENT OR PRODUCTION OF WEAPONS OF MASS DESTRUCTION, THE DEVELOPMENT OR PRODUCTION OF CHEMICAL OR BIOLOGICAL WEAPONS, ANY ACTIVITIES IN THE CONTEXT RELATED TO ANY NUCLEAR EXPLOSIVE OR UNSAFE NUCLEAR FUEL-CYCLE, OR IN SUPPORT OF HUMAN RIGHTS ABUSES.

IN THE EVENT OF ANY CONFLICTS BETWEEN THIS MANUAL AND THE APPLICABLE LAW, THE LATER PREVAILS.

Symbol Conventions

The symbols that may be found in this document are defined as follows.

Symbol	Description
 Danger	Indicates a hazardous situation which, if not avoided, will or could result in death or serious injury.
 Caution	Indicates a potentially hazardous situation which, if not avoided, could result in equipment damage, data loss, performance degradation, or unexpected results.
 Note	Provides additional information to emphasize or supplement important points of the main text.

Safety Instruction

These instructions are intended to ensure that user can use the product correctly to avoid danger or property loss.

Laws and Regulations

- Use of the product must be in strict compliance with the local electrical safety regulations.

Transportation

- Keep the device in original or similar packaging while transporting it.
- Keep all wrappers after unpacking them for future use. In case of any failure occurred, you need to return the device to the factory with the original wrapper. Transportation without the original wrapper may result in damage on the device and the company shall not take any responsibilities.
- Do not drop the product or subject it to physical shock. Keep the device away from magnetic interference.

Power Supply

- Input voltage should meet the Limited Power Source (Detector: 12 VDC, camera: 12 VDC, 24 VAC, or PoE(802.3af) according to the IEC61010-1 standard. Please refer to technical specifications for detailed information.
- Make sure the plug is properly connected to the power socket.
- DO NOT connect multiple devices to one power adapter, to avoid over-heating or fire hazards caused by overload.

Battery

- Improper use or replacement of the battery may result in explosion hazard. Replace with the same or equivalent type only. Dispose of used batteries in conformance with the instructions provided by the battery manufacturer.
- The built-in battery cannot be dismantled. Please contact the manufacture for repair if necessary.
- For long-term storage of the battery, make sure it is fully charged every half year to ensure the battery quality. Otherwise, damage may occur.

Maintenance

- If the product does not work properly, please contact your dealer or the nearest service center. We shall not assume any responsibility for problems caused by unauthorized repair or maintenance.
- A few device components (e.g., electrolytic capacitor) require regular replacement. The average lifespan varies, so periodic checking is recommended. Contact your dealer for details.
- Wipe the device gently with a clean cloth and a small quantity of ethanol, if necessary.
- If the equipment is used in a manner not specified by the manufacturer, the protection provided by the device may be impaired.

Using Environment

- Make sure the running environment meets the requirement of the device. The operating temperature shall be -10°C to 55°C (walk through metal door), 5°C to 40°C (speed dome), and the operating humidity shall be 95% or less, no condensing.
- DO NOT expose the device to high electromagnetic radiation or dusty environments.
- DO NOT aim the lens at the sun or any other bright light.

Emergency

- If smoke, odor, or noise arises from the device, immediately turn off the power, unplug the power cable, and contact the service center.

Manufacture Address

No.555 Qianmo Road, Binjiang District, Hangzhou 310052, China
Hangzhou Hikvision Digital Technology Co.,Ltd

Contents

Chapter 1 Over View	6
System Description	6
Functions	7
Key Features	7
Metal Detection Features	7
Thermal Imaging Features	7
Chapter 2 Installation	9
1.2 Installation Environment	9
1.3	
2.1.1 Fixed Metal Object	9
2.1.2 Ground Vibration	9
2.1	
2.1.3 Moving Metal Object	9
2.1.4 Radiated Electronic Interference	10
2.1.5 Conducting Electronic Interference	10
Security Check Point Layout	11
Side-by-Side Installation	11
2.2	
2.3.1 Install Two Detectors	11
2.3	
2.3.2 Install Three Detectors	12
Installation and Wiring	12
Chapter 3 Calibration	15
3.1 Principle	15
3.2 Factory Settings	15
3.3 Calibration Progress	15
Chapter 4 Metal Detector Local Configuration	17
Chapter 5 Thermal Camera Configuration	19
Description of Thermal Camera	19
5.2	
5.1.1 Brief Description	19
5.1.2 Function	19
Device Activation and Accessing	20
5.3	
5.2.1 Activate the Device via SADP	20
5.2.2 Activate the Device via Browser	20
5.2.3 Login	21
Temperature Measurement	22
5.4	
5.3.1 Notice	22
5.3.2 Automatic Thermography	22
5.3.3 Manual Thermography	26
5.5	
5.3.4 Measure Body Temperature	26
Body Thermography	28
5.4.1 Set Body Thermography Parameters	28
5.4.2 Set Body Thermography	29
5.4.3 Set Face Capture	30
Event and Alarm	32

	5.5.1 Set Motion Detection	32
	5.5.2 Set Video Tampering Alarm.....	33
	5.5.3 Set Alarm Input	34
	5.5.4 Set Exception Alarm	35
	5.5.5 Detect Audio Exception.....	35
	Arming Schedule and Alarm Linkage	36
	5.6.1 Set Arming Schedule	36
	5.6.2 Linkage Method Settings.....	36
	Live View	40
5.6	5.7.1 Live View Parameters	40
	5.7.2 Set Transmission Parameters	42
	Video and Audio.....	44
5.7	5.8.1 Video Settings	44
	5.8.2 Display Settings	47
5.8	5.8.3 OSD.....	53
	5.8.4 Set Privacy Mask	53
	5.8.5 8.5 Overlay Picture	53
	5.8.6 Set Manual DPC (Defective Pixel Correction).....	54
	5.8.7 Set Picture in Picture	54
	Video Recording and Picture Capture	55
5.9	5.9.1 Storage Settings.....	55
	5.9.2 Video Recording	57
	5.9.3 Capture Configuration.....	58
5.10	Network Settings.....	60
	5.10.1 TCP/IP	60
	5.10.2 Port.....	61
	5.10.3 Port Mapping	61
	5.10.4 Multicast	62
	5.10.5 SNMP.....	62
	5.10.6 Access to Device via Domain Name	62
	5.10.7 Access to Device via PPPoE Dial Up Connection	63
	5.10.8 Enable Hik-Connect Service on Camera	64
5.11	5.10.9 Set ISUP	65
	5.10.10 Set ONVIF	65
	5.10.11 Set HTTP Listening.....	65
	System and Security	67
	5.11.1 View Device Information.....	67
	5.11.2 Search and Manage Log	67
	5.11.3 Import and Export Configuration File	67
	5.11.4 Export Diagnose Information	67
	5.11.5 Reboot.....	67
	5.11.6 Restore and Default.....	67
	5.11.7 Upgrade.....	68
	5.11.8 View Open Source Software License.....	68

5.11.9 Time and Date	68
5.11.10 Set RS-232	69
5.11.11 Set RS-485	69
5.11.12 Set Same Unit.....	70
5.11.13 Security	70
5.11.14 User and Account.....	73
Appendix	75
FAQ.....	75
Common Material Emissivity Reference	75
Detector Zone Schematic Diagram	77
Detection Sensitivity for Guns.....	78
Dimension	80
Detection Program	81
Specification	82

Chapter 1 Over View

1.1 System Description



ISD-SMG318LT-F walk-through metal detector, adopting the thermographic technology, realizes contactless temperature screening. AI detection function of the camera makes an accurate positioning of the skin-surface. The detector also supports metal detection.

This equipment is used to detect the metal items carried by personnel through the detection door, mainly used for weapons detection. The typical application environment including: ·

Airport port: passenger check; ·

Court: visitors check; ·

Prison: visitors check; ·

Meetings, public buildings, sports events: access control; ·

Power plant: employees and visitors check; ·

Factory: anti-theft; ·

Hotels, restaurants, entertainment venues, dance halls: visitors check

There is no health hazard will be caused to the pregnant woman, people wearing a pacemaker, or to any other person passing through the metal detector when the procedure is followed.

Functions

- Non-contact temperature measurement: skin-surface temperature screening with accurately personnel matching. Temperature accuracy: ± 0.5 °C , detection distance: 0.5 to 1.5 m, target height: 1.45 m to 1.85 m
- Temperature filtering: adjustable temperature threshold. An over-threshold temperature will trigger the audible strobe light
- 1.2 ● Counting display: displays the walk-through people number, metal alarm times, real time temperature, number of people in abnormal temperature
- Metal detection: metal likes a clip
- Multi-Area alarm: Indicates the metal position on the body. Max. 18 areas
- Modularized component: easy transmission and installation

Key Features

1.3

Metal Detection Features

- Detection accuracy: metal in the size like a clip is detectable on the middle of the detector. Goods like Belt buckle can be excluded. Copper, aluminum, and zinc (over 150 g) , controlled knife, and gun are detectable
- Anti-interference: multiple detector can work abreast at the same time
- Multi-area alarm: Indicates the metal position on the body. Max. 18 areas
- Frequency settings: 100 frequencies can be set, and different ring tone for different frequency
- Sensitivity Settings: 255 level of sensitivity can be set
- People counting: display the number of walk-through people and people in alarm
- Positioning LED: LEDs on the sides of the detector for indicating the position of the prohibited goods.
- LCD screen
- Storing sensitivity parameters for different scenes for shortcut settings.
- Material: PVC shell

Thermal Imaging Features

Smart Functions

- Temperature exception detection
- Linkage for audible alarm
- Linkage of white strobe light alarm

Thermal Imaging Functions

- Uncooled sensor, resolution: 160 x 120

- Supports AGC4.0, DDE, and 3DNR
- Supports dual-light fusion image
- Supports visible light and thermal imaging frame over lay
- 15 pseudo colors: white, black, red, etc.

Visible Light Functions

- 4 MP, 1/2.7 " CMOS, Max. resolution: 2688×1520@25fps
- Supports low bit rate, low latency and ROI
- Independent settings for day or night condition

System Functions

- Dual-channel, single IP
- Dual-streaming
- PoE power supply
- IP66 protective level
- Operation temperature: 5°C to 40°C, <95% RH

Interfaces

- 10M/100M self-adapting network interface
- Micro SD/Micro SDHC/Micro SDXC card (128G/256G) slot
- 1-ch alarm input/output
- 1-ch audio input/output
- 1-ch 12 VDC power input

Security

- Security verification, such as HTTPS, supports license creating
- Three level of users, IP address filtering, user and password authentication

Chapter 2 Installation

Installation Environment

In order to ensure the optimal operation of the detector and the maximum flow of people, the following important factors are taken into account to minimize the impacts made by different interference sources.

2.1

Large fixed or immovable metal objects should be at least 10cm (4in) away from the detector (to detect large metal objects). This has less impact on the sensitivity, but may make the detector more susceptible to vibration.

2.1.1 Fixed Metal Object

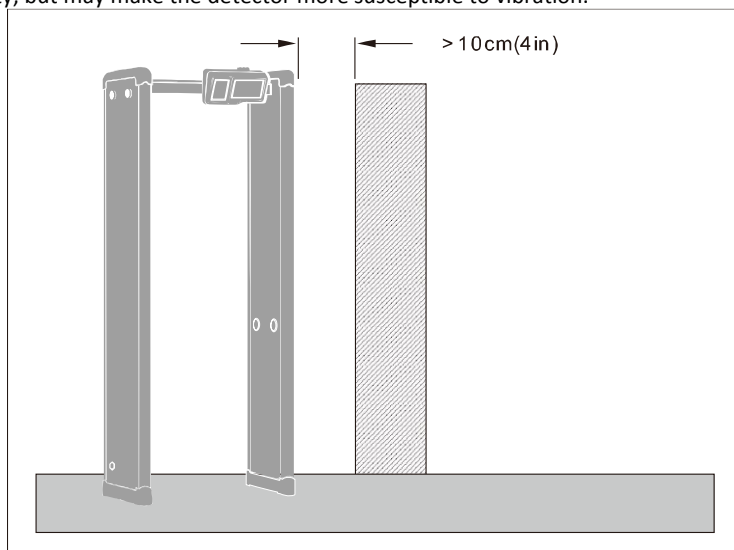

2.1.2 Ground Vibration

The ground should be flat, with strong support, to prevent vibration, especially when there are vibration metal structures under the ground.

2.1.3 Moving Metal Object

The large metal objects moving outside the detector shall be kept at least at a distance of 0.5-2m (20-79in) from the detector to avoid false alarm. According to the size of the metal object, the distance between the required moving metal object and the detector may differ.

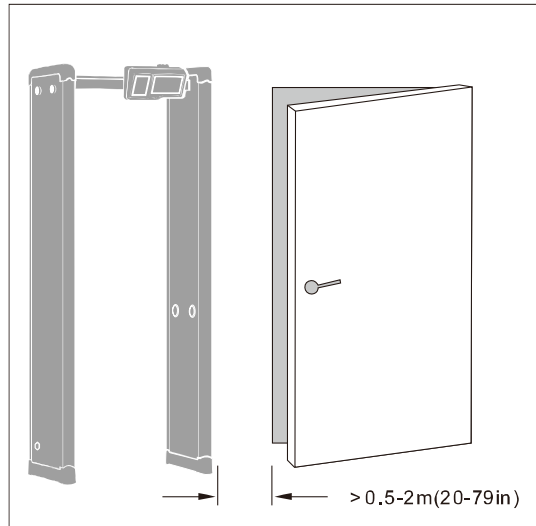

2.1.4 Radiated Electronic Interference
 The maximum distance between the electronic interference source and the receiving coil should be maximum. The recommended minimum distance is 0.5-4m (20-157in). However, the actual distance should vary according to the specific situation. The Interference may be caused by electronic control panel, radio equipment and computer, image display, high-power motor and transformer, AC wire, transistor control circuit, flash fluorescent lamp, ARC welding equipment, etc.

2.1.5 Conducting Electronic Interference

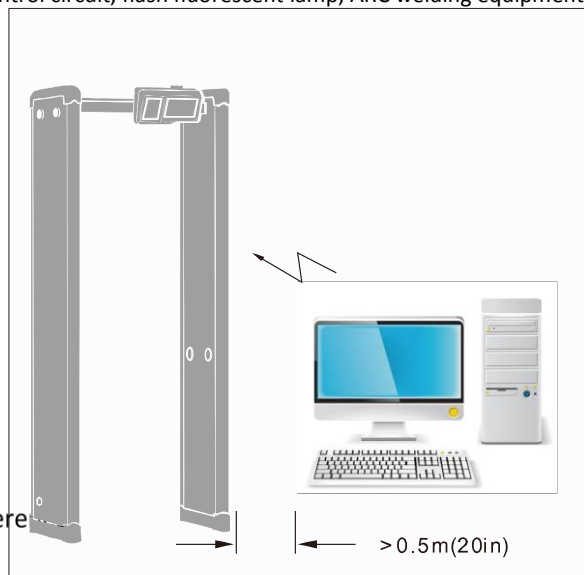

Connecting the power cable to a circuit that is not connected with other large load equipment may cause voltage shock. The recommended min. distance away from the interference source:

- A. With fixed metal object
- B. No moving metal object is allowed
- C. No electronic interference source is allowed

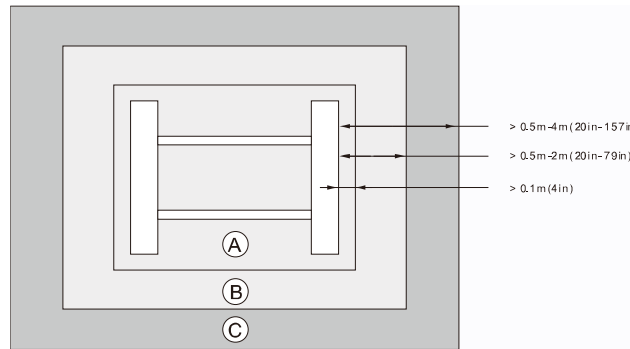

Note: Make the Receiving Coil (RX) away from the interference source. Make sure the interference level displayed on the environment inspection indicator is less than 2.

Security Check Point Layout

The performance of the check point may be impacted by the following causes:

- 2.2 ● Arrange the line of the waiting people. Make sure there is only one person in the detector for every check.
- Make sure the metal detector not interfere the operation of the detector.
- Additional baggage check to prevent false alarm

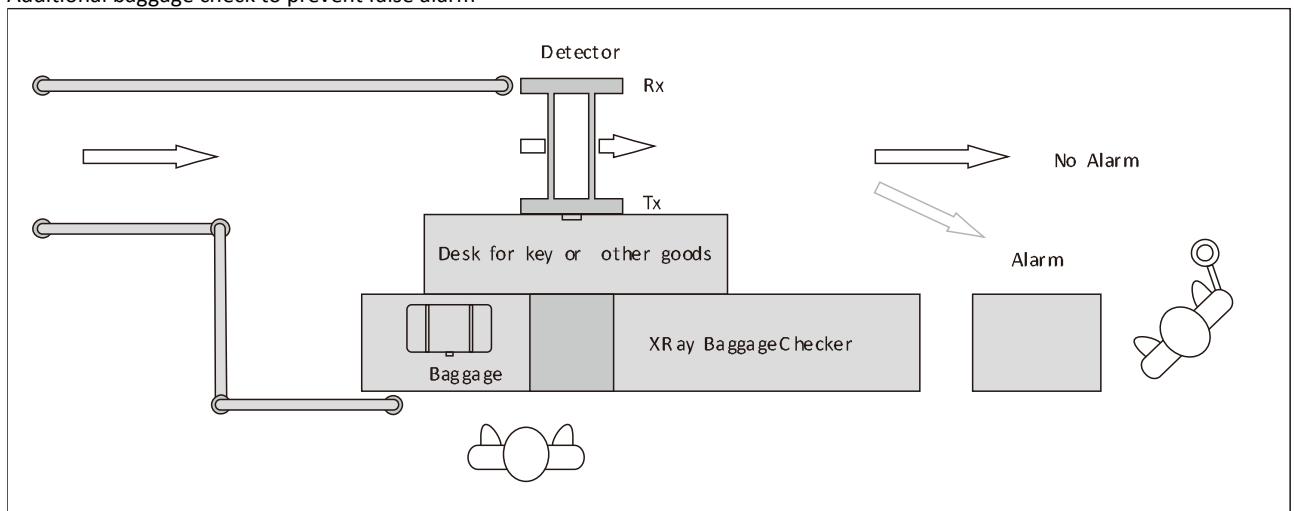

2.3

Side-by-Side Installation

Side-by-side operation refers to the operation of two or more detectors in close proximity to each other. With side-by-side operation, the detector may interfere with each other. The level of interference depends on the distance between the detector and their operating frequency and sensitivity.

2.3.1 Install Two Detectors

The detector has different working frequency selection. The recommended operating frequency should be between F1 and F3. According to the frequency combination of F1, F2 and F3, as well as the sensitivity, the minimum distance between the detectors is about 35 cm. You can also use the band F4 and F5, but in this condition, compared with only using frequency F1, F2, F3, the minimum distance can a bit bigger.

To meet the minimum distance, install the two receiving panel (Rx) and launch panel (Tx) (if possible, makes the distance between

the two launch panels as long as possible) as close as possible.
 Install the launch panel close to the interference sources.
 Use the frequency combination of lowest interference level

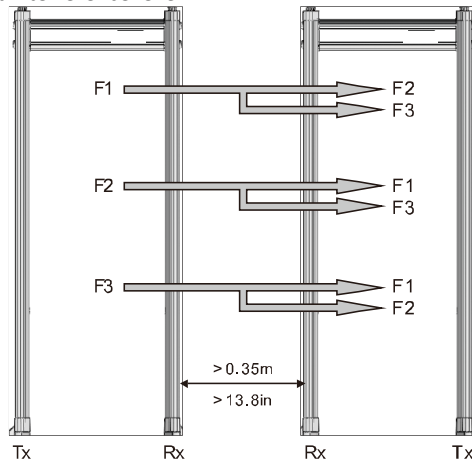

2.3.2 Install Three Det

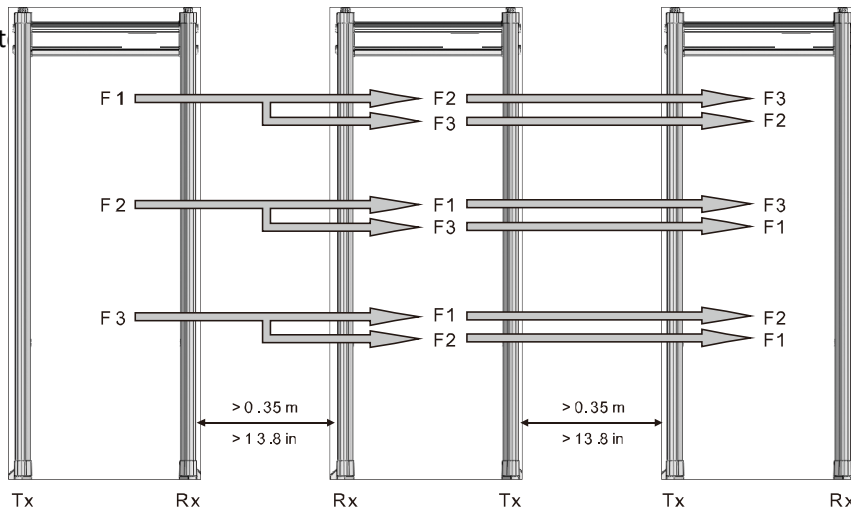

2.4

Installation and Wiring

1. Take out the device and accessories.

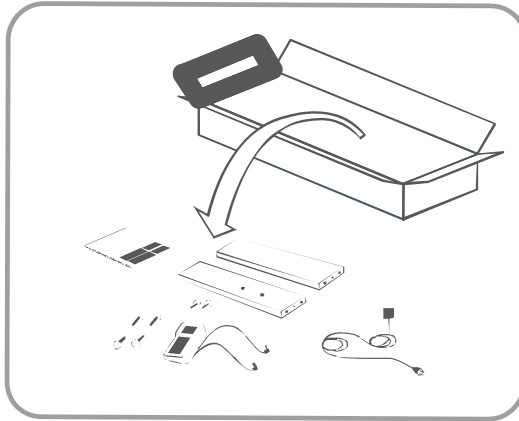

2. Install the door planks, beam, and main control panel. Tighten the screws to fix all the components.

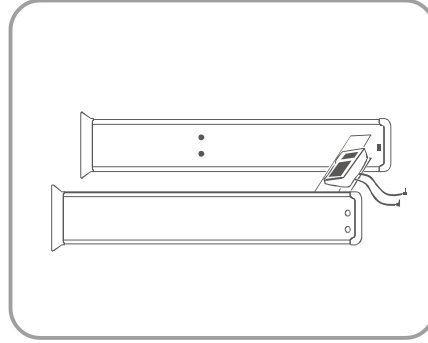
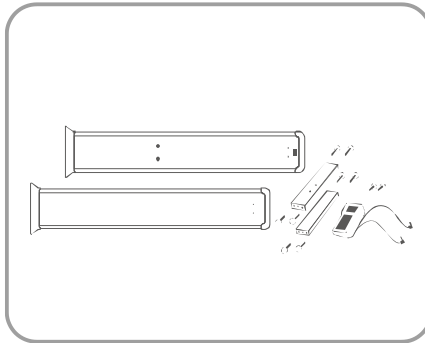

3. Connect the detection cables.

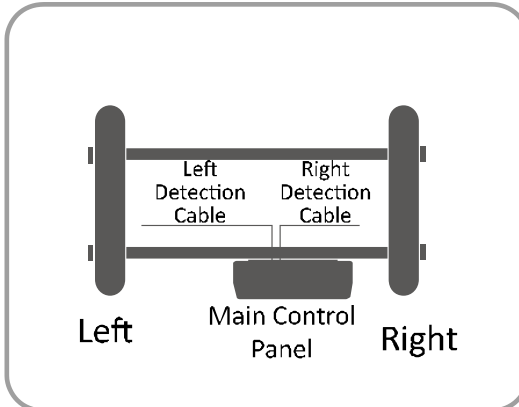

4. Take out the camera and mounting bracket.
5. Rotate and remove the enclosure.

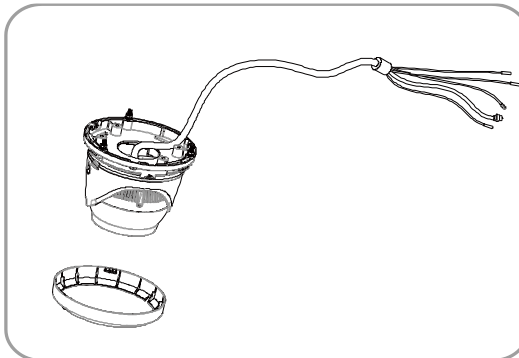

6. Route the cables through the cable hole, and fix the bracket on the camera with three screws.

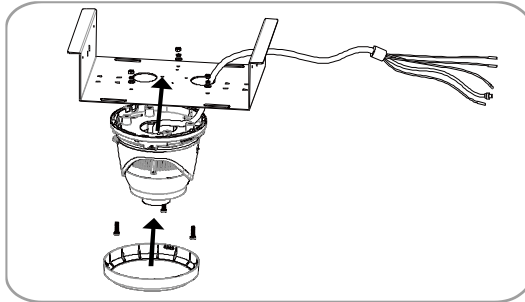

7. Rotate and install the enclosure.
8. Hang the camera (with mounting bracket) onto the beam.

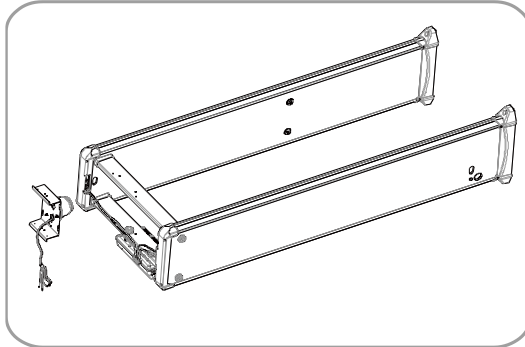

9. Secure the mounting bracket with four screws.

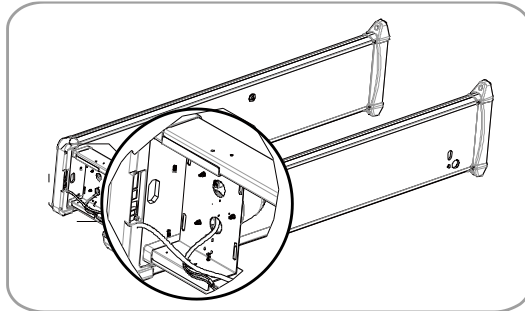

10. Adjust the camera to make it forward the people flow direction.
11. Upend the device.

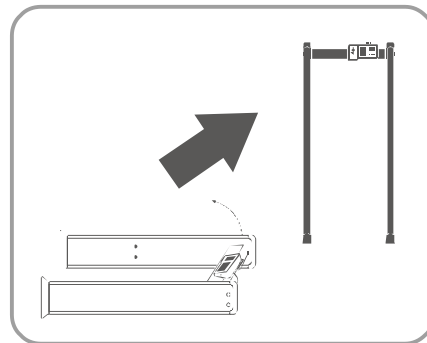
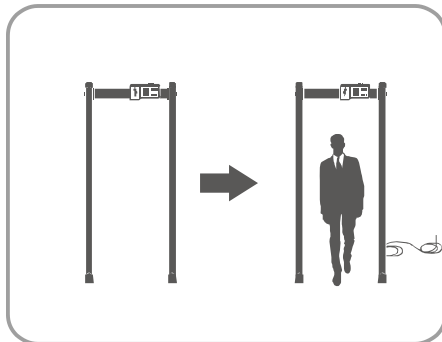

Chapter 3 Calibration

The purpose of the calibration is to enable the operational characteristics of the detector to meet the requirements of the security level. Calibration the detector before the security checkpoint starts work. Prior to calibration, probe requirements should be determined, for example, what is most dangerous goods likely to be detected. The detector should be calibrated with a reference representing the danger level.

Principle

1. Select the Operating Frequency

Select the interference that has the lowest level of background (up to 1 to 2 red light flashing)

2. Set the Detection Sensitivity

- 3.1 Set the security level first, and then the zone sensitivity. Set proper parameters, as a high detection sensitivity may affect the anti-interference of the detector.

3. Choose

Set the detection program that generates the lowest metal signal when walk-through the detector with harmless items.

4. Test

Daily inspection:

- Calibration with test objects calibration
- Detective door mechanical fixation

Factory Settings

3.2

The manufacturer setting is a good starting for calibration. The calibration must be carried out at the installation place. Due to the different installation environment, the final detection parameters will vary slightly depending on the installation place.

The parameters set by the manufacturer are defined in the laboratory environment and may differ significantly from the actual installation environment.

3.3

Calibration Progress

1. Select operation frequency
2. Set detection sensitivity: safety level and zone sensitivity
3. Test

I. Select Frequency:

Select an appropriate operating frequency (with a sufficiently low level of background interference) and start the calibration.

- 1 Install the detector according to the instruction.
- 2 Make sure that the tester are not wearing any clothing containing metal components.

II. Set Detector Sensitivity

The purpose of the detection sensitivity settings is to find the lowest sensitivity settings so that the test object can still be detected with low sensitivity under the current detection program. It is possible to achieve a high pass rate by minimizing the useless alarm caused by non-hazardous substances.

Sensitivity settings will also affect the anti-interference of the detector. It is not recommended to use a sensitivity that is too high for the operation place.

In order to adjust the detection sensitivity, the test object should be placed in different positions on the body in different ways and carried through the detector.

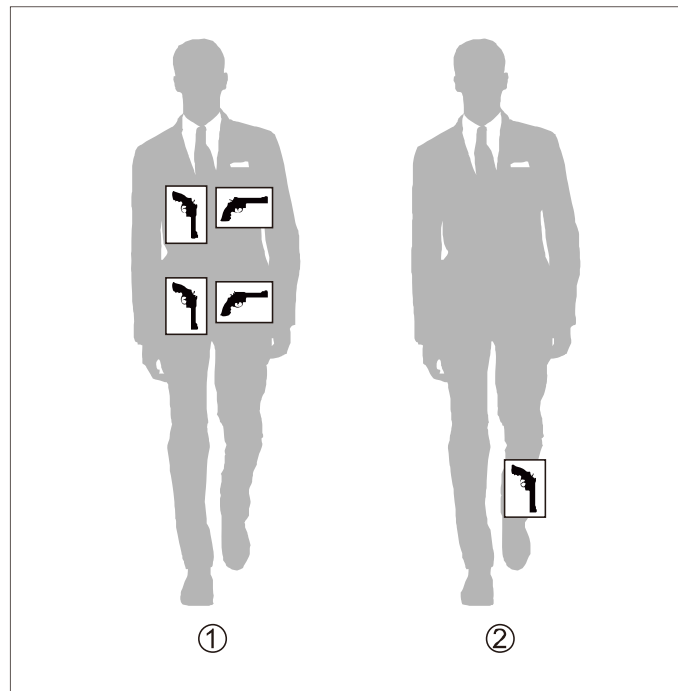

Steps:

1. Define the overall sensitivity, which can be adjusted manually(except for ankle height).
2. Define ankle height sensitivity (zone sensitivity). Manual ground sensitivity adjustment is available.
3. For different installation place, the amount and orientation of metal in the ground where the probe door is located may vary. The required ground height sensitivity settings varies according to the place situation.

Set Zone Sensitivity

After adjusting the safety level, fix the key test item in the ankle position and carry the item through the detector. Walk through the detector in at least two ways: A. Step one foot with the test item in the center of the detector. B. Step over the center of the detector with one foot with the test item.

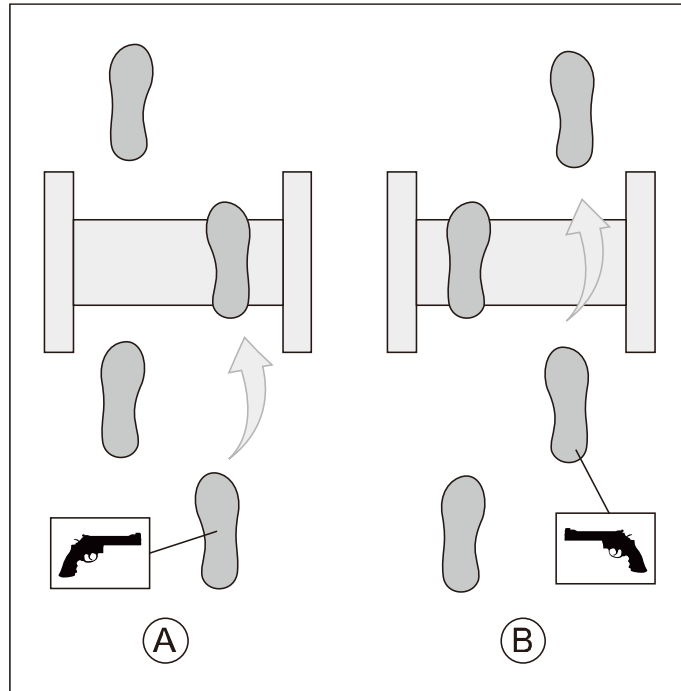

III. Test

Daily inspection:

- Calibration with test objects calibration
- Detective door mechanical fixation

Chapter 4 Metal Detector Local Configuration

Before use, the frequency of the detection gate (50/60hz) should be set according to the power frequency of different countries. The frequency setting will affect the performance of the detection gate detector.

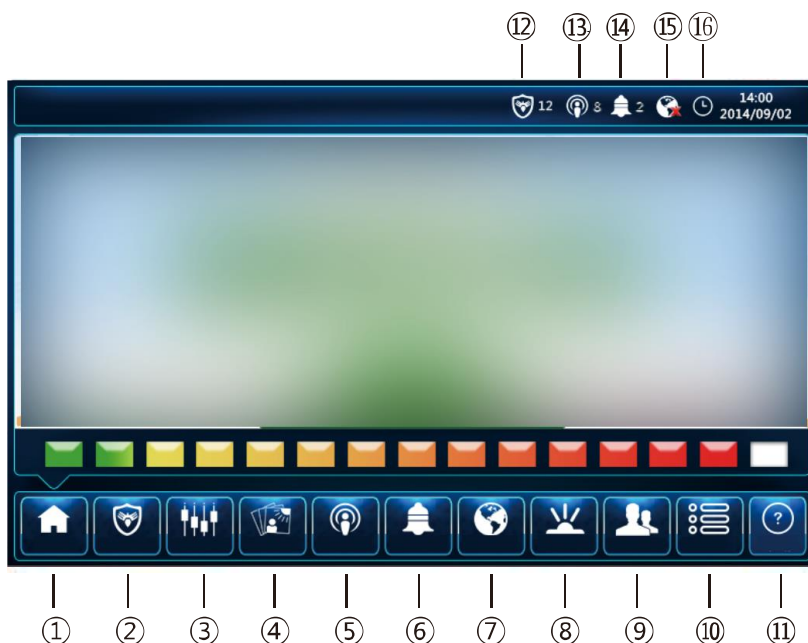

1	Home: standby interface/alarm interface/working environment monitoring
2	Security level: with 1 0 0 levels can be adjusted, the higher the level, the higher the sensitivity/mode selection.
3	Zone sensitivity: the highest sensitivity is 255, and the lowest is 0. There are two kinds of sensitivity Settings: automatic and manual.
4	Place: according to different application occasions and detection requirements, the system has preset dozens of solutions, which is convenient for customers to quickly set up and use.
5	Working frequency band: there are 100 working frequency bands that can be set. The setting mode can be manual or automatic.
6	Alarm: the alarm setting can be selected: the traditional alarm sound, and the sound size can be adjusted.
7	Networking: there are currently Bluetooth (available when upgrades)
8	Infrared: there are 4 kinds of infrared enable/disable states
9	Administrator: set the login administrator account
10	More: <ul style="list-style-type: none"> ● Check the security record: you can check the number of people passed, the number of people returned, the number of people trigger the alarm, the number of returned people triggered the alarm ● Screen Settings: adjustable screen brightness and screen saver sleep time ● Product registration: access to legitimate authorization ● System upgrade: for version update, restore factory settings Time setting: Set the system time
11	Help: obtain manufacturer's help information
12	Security level
13	Working frequency
14	Alarm setting
15	Networking status
16	Clock display

Chapter 5 Thermal Camera Configuration

Description of Thermal Camera

- 5.1 Thermal & Optical Bi-spectrum network camera equipped with built-in GPU which supports intelligent behavior analysis algorithm, can realize high-precision VCA detection and real-time alarm. It is applied to perimeter defense and fire-prevention purposes in critical infrastructures such as community, villa, construction site, factory, 4S stores, and so on. The pre-alarm system helps you
- 5.1.1 Brief Description
detect abnormal events immediately and protects your property.

This section introduces main functions of the device.

5.1.2 Function

Body Thermography

Device can measure the human body temperature or skin-surface temperature. The device alarms when temperature exceeds the alarm threshold.

Temperature Measurement

Device can measure the actual temperature of the spot being monitored. The device alarms when temperature exceeds the temperature threshold value.

Device Activation and Accessing

To protect the security and privacy of the user account and data, you should set a login password to activate the device when access the device via network.



Note

Refer to the user manual of the software client for the detailed information about the client software activation.

5.2

Search and activate the online devices via SADP software.

Before You Start

5.2.1 Access www.hikvision.com to get SADP software to install.

Steps

1. Connect the device to network using the network cable.
 2. Run SADP software to search the online devices.
 3. Check **Device Status** from the device list, and select **Inactive** device.
 4. Create and input the new password in the password field, and confirm the password.
-



Caution

We highly recommend you create a strong password of your own choosing (using a minimum of 8 characters, including upper case letters, lower case letters, numbers, and special characters) in order to increase the security of your product. And we recommend you reset your password regularly, especially in the high security system, resetting the password monthly or weekly can better protect your product.

5. Click **OK**.

Device Status changes into **Active**.

6. Optional: Change the network parameters of the device in **Modify Network Parameters**.

5.2.2 Activate the Device via Browser

You can access and activate the device via the browser.

Steps

1. Connect the device to the PC using the network cables.
 2. Change the IP address of the PC and device to the same segment.
-



Note

The default IP address of the device is 192.168.1.64. You can set the IP address of the PC from 192.168.1.2 to 192.168.1.253 (except 192.168.1.64). For example, you can set the IP address of the PC to 192.168.1.100.

3. Input **192.168.1.64** in the browser.

4. Set device activation password.



Caution

We highly recommend you create a strong password of your own choosing (using a minimum of 8 characters, including at least three of the following categories: upper case letters, lower case letters, numbers, and special characters) in order to increase the security of your product. And we recommend you reset your password regularly, especially in the high security system, resetting the password monthly or weekly can better protect your product.

5. Click **OK**.
6. Input the activation password to log in to the device.
7. Optional: Go to **Configuration** → **Network** → **Basic** → **TCP/IP** to change the IP address of the device to the same segment of your network.

Log in to the device via Web browser.

5.2.3 Login

I. Install Plug-in

You can access the device by installing plug-in.

Steps

1. Input IP address of the device in web browser and the login window will pop up.
2. Install the plug-in according to the prompt.
3. Open the web browser again and input IP address of the device.
4. Input user name and password, and click **Login**.

Help Get online help document of the device.

Logout You can exit safely.

II. Illegal Login Lock

It helps to improve the security when accessing the device via Internet.

The admin user can set the login attempts with the wrong password. When your login attempts with the wrong password reach the set times, the device is locked.

Go to **Configuration** → **System** → **Security** → **Security Service**, and enable **Enable Illegal Login Lock**, and set the illegal login attempts.

Temperature Measurement

When you enable this function, the device measures the actual temperature of the scene. It alarms when temperature exceeds the temperature threshold value.

- 5.3 This part introduces the notices of configuring temperature measurement function.
- The target surface should be as vertical to the optical axis as possible. It is recommended that the angle of oblique image plane should be less than 45°.
 - The target image pixels should be more than 5 × 5.
- 5.3.1 Notice
- If multiple presets will be taken for temperature measurement, it is recommended to set the patrol time above 20 s.
 - Please select line thermography or area thermography for a certain area temperature measurement. The point thermography is not recommended in case of deviation occurred during device movement to affect the accuracy of temperature measurement.

Configure the temperature measurement parameters and temperature measurement rules. The device can measure the actual temperature and output alarms when temperature exceeds the alarm threshold value.

5.3.2 Automatic Thermography

I. Set Thermography Parameters

Configure the parameters of temperature measurement.

Before You Start

Go to **Configuration** → **System** → **Maintenance** → **VCA Resource Type**, select **Temperature Measurement**.

Steps

1. Go to **Configuration** → **Local**, enable **Display Temperature Info.** .

Display Temperature Info.

Select **Yes** to display temperature information on live view.

Enable **Rules** to display the rules information on live view.

2. Click **Save**.

3. Go to **Configuration** → **Temperature Measurement** → **Basic Settings** to configure parameters.

Enable Temperature Measurement

Check to enable temperature measurement function.

Enable Color-Temperature

Check to display Temperature-Color Ruler in live view.

Display Temperature Info. on Stream

Check to display temperature information on the stream.

Display Temperature in Optical Channel

Check to display thermal channel temperature information in the optical channel.

Display Max./Min./Average Temperature

Check to display maximum/minimum/average temperature information on liveview when the temperature measurement rule is line or area.

Position of Thermometry Info

Select the position of temperature information showed on the live view.

- Near Target: display the information beside the temperature measurement rule.

- Top Left: display the information on the top left of screen.

Add Original Data on Capture

Check to add data on alarm triggered capture of thermal channel.

Add Original Data on Stream

Check to add original data on thermal view.

Data Refresh Interval

It means the refresh interval of temperature information.

Unit

Display temperature with Degree Celsius (°C)/Degree Fahrenheit (°F)/Degree Kelvin (K).

Temperature Range

Select the temperature measurement range.

Version

View the version of current algorithm.

4. Click **Save**.

II. Set Normal Mode

This function is used to measure the temperature of the whole scene and alarm.

Steps

1. Go to **Configuration** → **Temperature Measurement** → **Basic Settings**, and check **Enable Temperature Measurement**.
2. Refer to **Set Thermography Parameters** to set the parameters.
3. Go to **Configuration** → **Temperature Measurement** → **Advanced Settings**, and select **Normal**.
4. Configure the parameters of normal mode.

Emissivity

Set the emissivity of your target. The emissivity of each object is different.

Distance

The distance between the target and the device.

Pre-Alarm Threshold

When the temperature of target exceeds the pre-alarm threshold, and this status keeps more than **Filtering Time**, it triggers pre-alarm.

Alarm Threshold

When the temperature of target exceeds the alarm threshold, and this status keeps more than **Filtering Time**, it triggers alarm.

Pre-Alarm Output and Alarm Output

Check **Pre-Alarm Output** and **Alarm Output** to link the pre-alarm or alarm with the connected alarm device.

5. Refer to **Set Arming Schedule** for setting scheduled time. Refer to **Linkage Method Settings** for setting linkage method.
6. Click **Save**.

The maximum and minimum temperature will be displayed on the live view.



Go to **Image** → **VCA Rules Display** to adjust the fonts size and the temperature colour of normal, alarm and pre-alarm.

III. Set Expert Mode

Select the temperature measurement rules from **Point**, **Line**, or **Area** and configure parameters, the device alarms if the alarm rules are met.

Steps

1. Go to **Configuration** → **Temperature Measurement** → **Basic Settings**, check **Enable Temperature Measurement**.
2. Refer to **Set Thermography Parameters** to set the parameters.
3. Go to **Configuration** → **Temperature Measurement** → **Advanced Settings**, select **Expert**.
4. Select and enable the temperature measurement rules. Please refer to **Set Thermography Rule** for setting the rule.
5. Optional: Click **Area's Temperature Comparison** to set the alarm rules and the temperature.
6. Refer to **Set Arming Schedule** for setting scheduled time. Refer to **Linkage Method Settings** for setting linkage method.
7. Click **Save**.

The maximum temperature and thermography rules will be displayed on the liveview.



Go to **Image** → **VCA Rules Display** to adjust the fonts size and the temperature colour of normal, alarm and pre-alarm.

IV. Set Thermography Rule

Steps

1. Customize the rule name.
2. Select the rule **type** to Point, Line, or Area. Then draw a point, line, or area on the interface where the position to be measured.

Point Please refer to **Point Thermography** for detailed configuration.

Line Please refer to **Line Thermography** for detailed configuration.

Area Please refer to **Area Thermography** for detailed configuration.

3. Configure the temperature measurement parameters.

Emissivity

Set the emissivity of the target. The emissivity of the surface of a material is its effectiveness in emitting energy as thermal radiation. Different objects have different emissivity. Refer to **Common Material Emissivity Reference** to search for the target emissivity..

Distance

The distance between the target and the device.

Reflective Temperature

If there is any object with high emissivity in the scene, check and set the reflective temperature to correct the temperature. The reflective temperature should be set the same as the temperature of the high emissivity object.

4. Click **+** and set the **Alarm Rule**.

Alarm Temperature and Pre-Alarm Temperature

Set the alarm temperature and pre-alarm temperature. E.g., select Alarm Rule as Above (Average Temperature), set the Pre-Alarm Temperature to 50 °C, and set the Alarm Temperature to 55 °C. The device pre-alarms when its average temperature is higher than 50 °C and alarms when its average temperature is higher than 55 °C.

Filtering Time

It refers to the duration time after the target temperature reaches or exceeds the pre-alarm temperature/alarm temperature.

Tolerance Temperature

Set the tolerance temperature to prevent the constant temperature change to affect the alarm. E.g., set tolerance temperature as 3°C, set alarm temperature as 55°C, and set pre-alarm temperature as 50°C. The device sends pre-alarm when its temperature reaches 50°C and it alarms when its temperature reaches 55°C and only when the device temperature is lower than 52°C will the alarm be cancelled.

Pre-Alarm Output and Alarm Output

When the temperature of target exceeds the pre-alarm or alarm threshold, it triggers the pre-alarm or alarm output of the connected device.

Area's Temperature Comparison

Select two areas and set the comparison rule, and set the temperature difference threshold. The device alarms when the temperature difference meets the setting value.

5. You can shield certain area from being detected. Refer to **Set Shielded Region** for detailed settings.
6. Click **Save**.
Click **Live View**, and select thermal channel to view the temperature and rules information on live view.

V. Point Thermography

Configure the temperature measurement rule and click any point in live view to monitor the temperature.

Steps

1. Click in the live view and a cross cursor showed on the interface.
2. Drag the cross cursor to desired position.
Go to **Live View** interface to view the temperature and rule of the point in thermal channel.

VI. Line Thermography

Configure the temperature measurement rule and monitor the maximum temperature of the line.

Steps

1. Click and drag the mouse to draw a line in the live view interface.
2. Click and move the line to adjust the position.
3. Click and drag the ends of the line to adjust the length.
Go to **Live View** interface to view the maximum temperature and rule of the line in thermal channel.

VII. Area Thermography

Configure the temperature measurement rule and monitor the maximum temperature of the area.

Steps



1. Click and drag the mouse in the liveview to draw the area and right click to finish drawing.
2. Click and move the area to adjust the position.
3. Drag the corners of the area to adjust the size and shape.
Go to **Live View** interface to view the maximum temperature and rule of the area in thermal channel.

VIII. Set Shielded Region

You can configure areas from being detected.

Steps

1. Check **Enable Shield Area**.

2. Click .
3. Drag the mouse in the live view to draw the area. You can drag the corners of the red rectangle area to change its shape and size.
4. Right click the mouse to stop drawing.
5. Optional: Select one area and click  to delete it.
6. Click **Save**.

After enable the manual thermography function of the device, you can click any position on the live view to show the real temperature.

Steps

1. Go to **Configuration** → **Local** and select **Display Temperature Info.** as **Yes**.
2. Go to **Configuration** → **Temperature Measurement** → **Basic Settings**.
3. Check **Enable Temperature Measurement**.
4. Click **Save**.
5. Go to live view interface and select thermal channel, click . Click any position on the interface to show the real temperature.

5.3.4 Measure Body Temperature

1. Go to **Configuration** → **Temperature Measurement** → **Body Thermography Configuration**.
2. Select thermal channel.
3. Click **Draw Area**, then click the mouse on the black body in live view and save it.
4. Set the black body parameters.

- Emissivity: Set the emissivity of black body.

Note

Refer to the emissivity table for reference in the manual or online.

- Distance: The straight-line distance between the black body and the device.
 - Temperature: Enter the temperature of the black body.
-

Note

If there is no black body in the scene, skip step 3 and 4 .

5. Set **Environmental Temperature Mode**. **Auto** and **Manual** are selectable. In auto mode, the device detects environment temperature automatically. In manual mode, you should enter environment temperature manually.
6. Set the body temperature compensation parameters if you need to detect human body temperature instead of shell temperature.
 - i. Enable body temperature compensation function.
 - ii. Select the compensation type.
 - iii. In auto mode, the device calculates compensation value automatically. If the detected body temperature is still inaccuracy, you can set **Manual Calibration value**.
 - iv. In manual mode, you should enter **Manual Calibration** value, and corresponding compensation value displays in **Compensation Value** field.
7. Click **Save**.
8. Set the arming schedule and linkage methods. For the information about arming schedule settings, see **Set Arming Schedule**. For the information about linkage methods, see **Linkage Method Settings**.

Body Thermography

Body Thermography function can detect temperature of human face or body in the scene, and output alarm if the temperature is higher than the setting value.

5.4 Configure the parameters of body temperature measurement.

Before You Start

Go to **Configuration** → **System** → **Maintenance** → **VCA Resource Type**, select **Body Thermography**.

5.4.1 Set Body Thermography Parameters

1. Go to **Configuration** → **Temperature Measurement** → **Basic Settings** to configure parameters.

Enable Temperature Measurement

Check to enable temperature measurement function.

Enable Color-Temperature

Check to display Temperature-Color Ruler in live view.

Display Temperature Info. on Stream

Check to display temperature information on the stream.

Add Original Data on Capture

Check to add data on alarm triggered capture of thermal channel.

Add Original Data on Stream

Check to add original data on thermal view.

Data Refresh Interval

It means the refresh interval of temperature information.

Unit

Display temperature with Degree Celsius (°C)/Degree Fahrenheit (°F)/Degree Kelvin (K).

Temperature Range

Select the temperature measurement range.

Distance:

Set the distance between device and the target.

Emissivity

Set the emissivity of your target.



Refer to the emissivity table for reference in the manual or online.

Version

View the version of current algorithm.

2. Click **Save**.

I. Measure Body Temperature in Thermal Channel

5.4.2 ~~Set~~ Body Thermography

1. Go to **Configuration** → **Body Thermography** → **Body Thermography Configuration**.
2. Select thermal channel.
3. Click **Draw Area**, then click the mouse on the black body in live view and save it.
4. Set the black body parameters.
 - Emissivity: Set the emissivity of black body.



Refer to the emissivity table for reference in the manual or online.

- Distance: The straight-line distance between the black body and the device.
 - Temperature: Enter the temperature of the black body.
5. Set **Environmental Temperature Mode**. **Auto** and **Manual** are selectable. In auto mode, the device detects environment temperature automatically. In manual mode, you should enter environment temperature manually.
 6. Set the body temperature compensation parameters if you need to detect human body temperature instead of shell temperature.
 - i. Enable body temperature compensation function.
 - ii. Select the compensation type.
 - iii. In auto mode, the device calculates compensation value automatically. If the detected body temperature is still inaccuracy, you can set **Manual Calibration value**.
 - iv. In manual mode, you should enter **Manual Calibration** value, and corresponding compensation value displays in **Compensation Value** field.
 7. Click **Save**.
 8. Set the arming schedule and linkage methods. For the information about arming schedule settings, see **Set Arming Schedule**. For the information about linkage methods, see **Linkage Method Settings**.

II. Measure Face Temperature in Optical Channel

Steps:

1. Go to **Configuration** → **Body Thermography** → **Body Thermography Configuration**.
2. Select the optical channel.
3. Check **Enable Face Detection** to detect human faces, and measure the temperature in the scene.
4. Check **Display Temperature** to display the highest temperature of each detected face in live view.
5. Check **Upload Captured Face Image** to capture and upload the face image of the target. If face detection function is also enabled, max. temperature of the face displays on the image.



Refer to face capture section to set the corresponding parameters.

6. Check **Display Face Temperature Position** to show a cursor on the position of max. temperature.
7. Select **Configuration** mode. **Targeting** refers to measure the temperatures for all the targets in the scene, and output alarm if the target temperature is higher than the alarm threshold.



If temperatures of multiple targets are higher than the alarm threshold, then multiple alarms will be triggered.

8. Set the face detection parameters.
 - Pupil Distance: The pupil distance refers to the square size composed by the area between two pupils, and it is the basic standard for a camera to identify a target. You can enter the pupil distance value or draw pupil distance areas in live view.
 - Generation Speed: It refers to the target generation speed. The higher the value is, the easier the target can be detected.
 - Sensitivity: It refers to face detection sensitivity.
 - Alarm When Temperature is Above: It refers to the temperature alarm threshold. When the target temperature is higher than the setting value, the device outputs alarm.
 - Pre-Alarm Temperature: When the face temperature is higher than the set value, the device outputs pre-alarm and upload captured face image.
9. Click **Draw Area**, and draw a face detection area in live view. You can move the rectangle or drag the corners of rectangle to adjust the position and size.



You should draw the detection area within the red rectangle.

10. Click **Save**.
11. Set the arming schedule and linkage methods. For the information about arming schedule settings, see **Set Arming Schedule**. For the information about linkage methods, see **Linkage Method Settings**.

5.4.3 Set Face Capture

The camera can capture the face that appears in the configured area, and the face information will be uploaded with the captured picture as well.



I. Overlay and Capture

Steps:

1. Go to **Configuration>Body Thermography >Face Capture >Overlay and Capture**.
2. Check **Display Target info. on Alarm Picture** to show a frame on the target on the uploaded alarm picture.
3. Set the target picture size. Four types are available: **Custom**, **Head Shot**, **Half-Body Shot** and **Full-Body Shot**. If you select **Custom**, you can customized the width, head height and body height as required.
4. Check **Fixed Value** to set the picture height.
5. Check the **Background Upload** to upload the background image.
6. Select the **Picture Quality** and **Resolution** from the drop-down list.
7. Click **Save**.

II. Set Shield Region

The shield region allows you to set the specific region in which the face capture does not work. **Steps:**

1. Click  to draw shield area by left click end-points in the live view window, and right click to finish the area drawing.
2. Optional: Click  to delete the drawn areas.



You are allowed to draw up to 4 areas on the same image, and each area can be set with 3-10 points

3. Click **Save**.

III. Advanced Configuration

- **Face Capture Version:** It lists the version of the algorithms library.
- **Upload Feature:** Check to upload the feature of captured target.
- **Capture Times:** Refers to the capture times a face will be captured during its stay in the configured area.
- **Quick Shot:** You can define quick shot threshold and max. capture interval.
 - Quick Shot Threshold:** It stands for the quality of face to trigger quick shot.
 - Max. Capture Interval:** It describes the max. time occupation for one quick shot.
- **No Wearing Mask Linkage:** Check **Audible Warning**, the device will output audio alarm if the target is not wearing mask.

Event and Alarm

This part introduces the configuration of events. The device takes certain response to triggered alarm.

5.5 It helps to detect the moving objects in the detection region and trigger the linkage actions.

Steps

1. Go to **Configuration** → **Event** → **Basic Event** → **Motion Detection**.
2. Select the channel No.
3. Check **Enable Motion Detection**.
4. Optional: Highlight to display the moving object in the image in green.
 - 1) Check **Enable Dynamic Analysis for Motion**.
 - 2) Go to **Configuration** → **Local**.
 - 3) Set **Rules** to **Enable**.
5. Select **Configuration Mode**, and set rule region and rule parameters.
 - For the information about normal mode, see **Normal Mode**.
 - For the information about expert mode, see **Expert Mode**.
6. Set the arming schedule and linkage methods. For the information about arming schedule settings, see **Set Arming Schedule**. For the information about linkage methods, see **Linkage Method Settings**.
7. Click **Save**.

I. Normal Mode

You can set motion detection parameters according to the device default parameters.

Steps

1. Select normal mode in **Configuration**.
2. Set the sensitivity of normal mode. The higher the value of sensitivity is, the more sensitive the motion detection is. If the sensitivity is set to **0**, motion detection and dynamic analysis do not take effect.
3. Click **Draw Area**. Click and drag the mouse on the live video, then release the mouse to finish drawing one area.

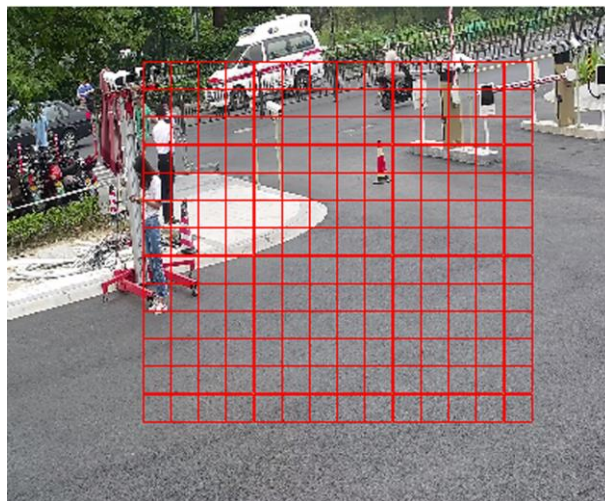

Figure 6-1 Set Rules

Stop Drawing

Stop drawing one area.

Clear All

Clear all the areas.

4. Optional: You can set the parameters of multiple areas by repeating the above steps.

II. Expert Mode

You can configure the motion detection parameters of day/night switch according to the actual needs.

Steps

1. Select expert mode in **Configuration**.
2. Set parameters of expert mode.

Day/Night Switch

OFF: Day/night switch is disabled.

Day/Night Auto-Switch: The system switches day/night mode automatically according to environment. It displays colored image at day and black and white image at night.

Day/Night Scheduled-Switch: The system switches day/night mode according to the schedule. It switches to day mode during the set periods and switches to night mode during the other periods.

Sensitivity

The higher the value of sensitivity is, the more sensitive the motion detection is. If the sensitivity is set to **0**, motion detection and dynamic analysis do not take effect.

3. Select an **Area** and click **Draw Area**. Click and drag the mouse on the live video, then release the mouse to finish drawing one area.

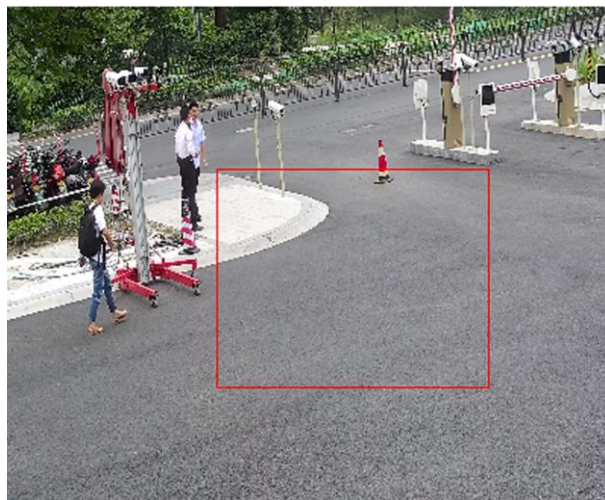

Figure 6-2 Set Rules

Stop Drawing

Finish drawing one area.

5.5.2 Set Video Tampering Alarm **Clear All** Delete all the areas.

4. Optional: Repeat the above steps to set multiple areas.

When the configured area is covered and cannot be monitored normally, the alarm is triggered and the device takes certain alarm response actions.

Steps

1. Go to **Configuration** → **Event** → **Basic Event** → **Video Tampering**.
2. Select the channel number.
3. Check **Enable**.

4. Set the **Sensitivity**. The higher the value is, the easier to detect the area covering.
5. Click **Draw Area** and drag the mouse in the live view to draw the area.

Stop Drawing	Finish drawing.
Clear All	Delete all the drawn areas.

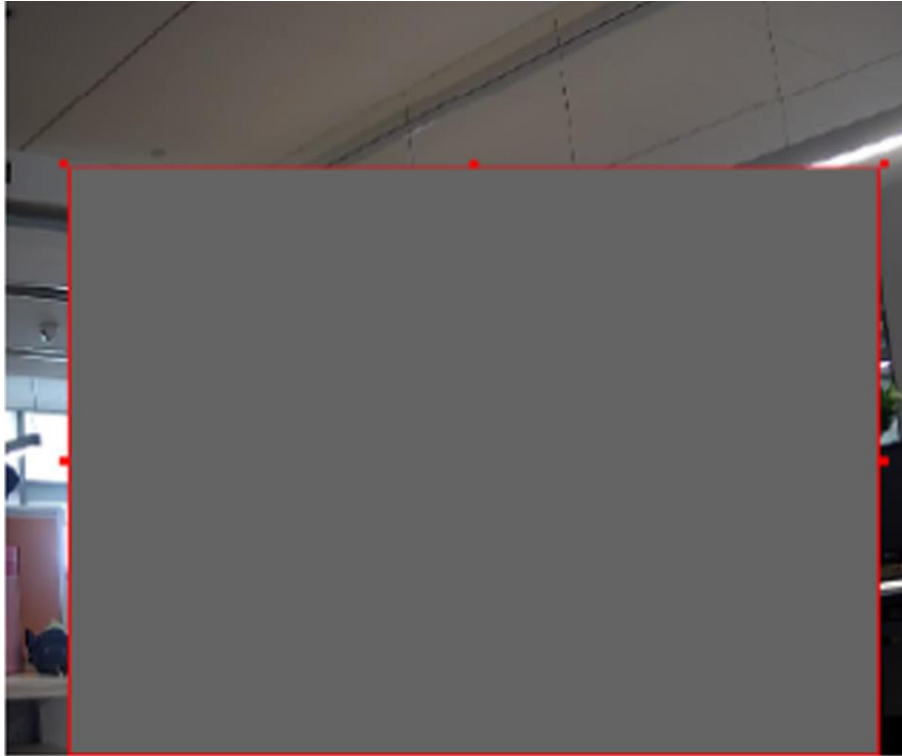

Figure 6-3 Set Video Tampering Area

6. Refer to **Set Arming Schedule** for setting scheduled time. Refer to **Linkage Method Settings** for setting linkage method.
7. Click **Save**.

5.5.3 Set Alarm Input

Alarm signal from the external device triggers the corresponding actions of the current device.

Before You Start

Make sure the external alarm device is connected. See *Quick Start Guide* for cables connection.

Steps

1. Go to **Configuration** → **Event** → **Basic Event** → **Alarm Input**.
2. Check **Enable Alarm Input Handling**.
3. Select **Alarm Input NO.** and **Alarm Type** from the dropdown list. Edit the **Alarm Name**.
4. Refer to **Set Arming Schedule** for setting scheduled time. Refer to **Linkage Method Settings** for setting linkage method.
5. Click **Copy to...** to copy the settings to other alarm input channels.
6. Click **Save**.

Exception such as network disconnection can trigger the device to take corresponding action.

Steps

1. Go to **Configuration** → **Event** → **Basic Event** → **Exception**.
2. Select **Exception Type**.

5.5.4 Set HDD Full Exception Alarm	The HDD storage is full.
HDD Error	Error occurs in HDD.
Network Disconnected	The device is offline.
IP Address Conflicted	The IP address of current device is same as that of other device in the network.
Illegal Login	Incorrect user name or password is entered.

3. Refer to **Linkage Method Settings** for setting linkage method.
4. Click **Save**.

5.5.5 Detect Audio Exception
Audio exception detection function detects the abnormal sound in the surveillance scene, such as the sudden increase/decrease of the sound intensity, and some certain actions can be taken as response.

Steps

1. Go to **Configuration** → **Event** → **Smart Event** → **Audio Exception Detection**.
2. Select one or several audio exception detection types.

Audio Loss Detection

Detect sudden loss of audio track.

Sudden Increase of Sound Intensity Detection

Detect sudden increase of sound intensity. **Sensitivity** and **Sound Intensity Threshold** are configurable.



- The lower the sensitivity is, the more significant the change should be to trigger the detection.
 - The sound intensity threshold refers to the sound intensity reference for the detection. It is recommended to set as the average sound intensity in the environment. The louder the environment sound, the higher the value should be. You can adjust it according to the real environment.
-

Sudden Decrease of Sound Intensity Detection

Detect sudden decrease of sound intensity. **Sensitivity** is configurable.

3. Refer to **Set Arming Schedule** for setting scheduled time. Refer to **Linkage Method Settings** for setting linkage methods.
 4. Click **Save**.
-



The function varies according to different models.

Arming Schedule and Alarm Linkage

Arming schedule is a customized time period in which the device performs certain tasks. Alarm linkage is the response to the detected certain incident or target during the scheduled time.

5.6 Set the valid time of the device tasks.

Steps

1. Click **Arming Schedule**.
2. Drag the time bar to draw desired valid time.

5.6.1 Set Arming Schedule



Up to 8 periods can be configured for one day.

3. Adjust the time period.
 - Click on the selected time period, and enter the desired value. Click **Save**.
 - Click on the selected time period. Drag the both ends to adjust the time period.
 - Click on the selected time period, and drag it on the time bar.
4. Optional: Click **Copy to...** to copy the same settings to other days.
5. Click **Save**.

5.6.2 Linkage Method Settings

You can enable the linkage functions when an event or alarm occurs.

I. Trigger Alarm Output

If the device has been connected to an alarm output device, and the alarm output No. has been configured, the device sends alarm information to the connected alarm output device when an alarm is triggered.

Steps

1. Go to **Configuration** → **Event** → **Basic Event** → **Alarm Output**.
2. Set alarm output parameters.

Automatic Alarm For the information about the configuration, see **Automatic Alarm**.

Manual Alarm For the information about the configuration, see **Manual Alarm**.

3. Click **Save**.

● Manual Alarm

You can trigger an alarm output manually.

Steps

1. Set the manual alarm parameters.

Alarm Output No.

Select the alarm output No. according to the alarm interface connected to the external alarm device.

Alarm Name

Custom a name for the alarm output.

Delay

Select **Manual**.

2. Click **Manual Alarm** to enable manual alarm output.
3. Optional: Click **Clear Alarm** to disable manual alarm output.

● Automatic Alarm

Set the automatic alarm parameters, then the device triggers an alarm output automatically in the set arming schedule.

Steps

1. Set automatic alarm parameters.

Alarm Output No.

Select the alarm output No. according to the alarm interface connected to the external alarm device.

Alarm Name

Custom a name for the alarm output.

Delay

It refers to the time duration that the alarm output remains after an alarm occurs.

2. Set the alarming schedule. For the information about the settings, see **Set Arming Schedule**.
3. Click **Copy to...** to copy the parameters to other alarm output channels.
4. Click **Save**.

II. FTP/NAS/Memory Card Uploading

If you have enabled and configured the FTP/NAS/memory card uploading, the device sends the alarm information to the FTP server, network attached storage and memory card when an alarm is triggered.

Refer to **Set FTP** to set the FTP server.

Refer to **Set NAS** for NAS configuration.

Refer to **Set Memory Card** for memory card storage configuration.

III. Send Email

Check **Send Email**, and the device sends an email to the designated addresses with alarm information when an alarm event is detected. For email settings, refer to **Set Email**.

Set Email

When the email is configured and **Send Email** is enabled as a linkage method, the device sends an email notification to all designated receivers if an alarm event is detected.

Before You Start

Set the DNS server before using the Email function. Go to **Configuration** → **Network** → **Basic Settings** → **TCP/IP** for DNS settings.

Steps

1. Go to email settings page: **Configuration** → **Network** → **Advanced Settings** → **Email**.
2. Set email parameters.
 - 1) Input the sender's email information, including the **Sender's Address**, **SMTP Server**, and **SMTP Port**.
 - 2) Optional: If your email server requires authentication, check **Authentication** and input your user name and password to log in to the server.
 - 3) Set the **E-mail Encryption**.
 - When you select **SSL** or **TLS**, and disable **STARTTLS**, emails are sent after encrypted by SSL or TLS. The SMTP port should be set as 465.
 - When you select **SSL** or **TLS** and **Enable STARTTLS**, emails are sent after encrypted by STARTTLS, and the SMTP port should be set as 25.



If you want to use STARTTLS, make sure that the protocol is supported by your email server. If you check the **Enable STARTTLS** while the protocol is not supported by your email sever, your email is sent with no encryption.

- 4) Optional: If you want to receive notification with alarm pictures, check **Attached Image**. The notification email has 3 attached alarm pictures about the event with configurable image capturing interval.
 - 5) Input the receiver's information, including the receiver's name and address.
 - 6) Click **Test** to see if the function is well configured.
3. Click **Save**.

IV. Notify Surveillance Center

Check **Notify Surveillance Center**, the alarm information is uploaded to the surveillance center when an alarm event is detected.

V. Trigger Recording

Check **Trigger Recording**, and the device records the video about the detected alarm event.
For device with more than one camera channels, you can set one or more channels to take recordings if needed.
For recording settings, refer to **Video Recording and Picture Capture**

VI. Set Audible Alarm Output

For device that supports audible warning as a linkage method, options are open to configure audible alarm parameters.

Steps



The function is only supported by certain camera models.

1. Go to the setting page: **Configuration** → **Event** → **Basic Event** → **Audible Alarm Output**.
2. Select desired alarm sound type and alarm times.
3. Set arming schedule for audible alarm. Refer to **Set Arming Schedule**
4. Click **Save**.

VII. Set Flashing Alarm Light Output

Steps

1. Go to **Configuration** → **Event** → **Basic Event** → **Flashing Alarm Light Output**.
2. Set **Flashing Duration**, **Flashing Frequency** and **Brightness**.

Flashing Duration

The time period the flashing lasts when one alarm happens.

Flashing Frequency

The flashing speed of the light. High, Medium, and Low are selectable.

Brightness

The brightness of the light.

3. Edit the arming schedule.

4. Click **Save**.



Only certain camera models support the function.

Live View





It introduces the live view parameters, function icons and transmission parameters settings.

5.7 Note

For multichannel devices, select the desired channel first before live view settings.

5.7.1 Live View Parameters

I. Window Division



-  refers to 1 × 1 window division.
-  refers to 2 × 2 window division.
-  refers to 3 × 3 window division.
-  refers to 4 × 4 window division.

II. Live View Stream Type

Select the live view stream type according to your needs. For the detailed information about the stream type selection, refer to *Stream Type*.

III. Enable and Disable Live View

This function is used to quickly enable or disable live view of all channels.

- Click  to start live view of all channels.
- Click  to stop live view of all channels.



IV. Start Digital Zoom

It helps to see a detailed information of any region in the image.

Steps

1. Click  to enable the digital zoom.
2. In live view image, drag the mouse to select the desired region.
3. Click in the live view image to back to the original image.

V. View Previous/Next Page

When the number of channels surpasses that of live view window division, this function can switch live view among multiple channels. Click   to switch live view among multiple channels.

VI. Full Screen

This function is used to view the image in full screen mode.
Click  to start full screen mode and press ESC button to exit.

VII. Light

Click  to turn on or turn off the illuminator.

VIII. Wiper

For the device that has a wiper, you can control the wiper via web browser.
Click  on live view page. The wiper wipes the window one time.

IX. Lens Initialization

Lens initialization is used on the device equipped with motorized lens. The function can reset lens when long time zoom or focus results in blurred image. This function varies according to different models.
Click  to operate lens initialization.

X. Auxiliary Focus

Click  to realize automatic focus. This function is subject to the actual device model.

XI. Quick Set Live View

It offers a quick setup of PTZ, display settings, OSD, video/audio and VCA resource settings on live view page.

Steps

1. Click  to show quick setup page.
2. Set PTZ, display settings, OSD, video/audio and VCA resource parameters.
 - For PTZ settings, see ***Lens Parameters Adjustment*** .
 - For display settings, see ***Display Settings***.
 - For OSD settings, see ***OSD***.
 - For audio and video settings, see ***Video and Audio***.
 - For VCA settings, see ***Temperature Measurement***, and ***Body Thermography***.





The function is only supported by certain models.



XII. Lens Parameters Adjustment

It is used to adjust the lens focus, zoom and iris.

Zoom

- Click , and the lens zooms in.
- Click , and the lens zooms out.



Focus

- Click , then the lens focuses far and the distant object gets clear.
- Click , then the lens focuses near and the nearby object gets clear.

PTZ Speed

Slide  to adjust the speed of the pan/tilt movement.

Iris

- When the image is too dark, click  to enlarge the iris.
- When the image is too bright, click  to stop down the iris.

5.7.2 Set Transmission Parameters

The live view image may be displayed abnormally according to the network conditions. In different network environments, you can adjust the transmission parameters to solve the problem.

Steps

1. Go to **Configuration** → **Local**.
2. Set the transmission parameters as required.

Protocol

TCP

TCP ensures complete delivery of streaming data and better video quality, yet the real-time transmission will be affected. It is suitable for the stable network environment.

UDP

UDP is suitable for the unstable network environment that does not demand high video fluency.

MULTICAST

MULTICAST is suitable for the situation that there are multiple clients. You should set the multicast address for them before selection.



For detailed information about multicast, refer to **Multicast**.

HTTP

HTTP is suitable for the situation that the third-party needs to get the stream from the device.

Play Performance

Shortest Delay

The device takes the real-time video image as the priority over the video fluency.

Balanced

The device ensures both the real-time video image and the fluency.

Fluent

The device takes the video fluency as the priority over real-time. In poor network environment, the device cannot ensure video fluency even the fluency is enabled.

Custom

You can set the frame rate manually. In poor network environment, you can reduce the frame rate to get a fluent live view. But the rule information may not display.

Auto Start Live View

- **Yes** means the live view is started automatically. It requires a high performance monitoring device and a stable network environment.
- **No** means the live view should be started manually.

3. Click **OK**.

Video and Audio

This part introduces the configuration of video and audio related parameters.

5.8 This part introduces the settings of video parameters, such as, stream type, video encoding, and resolution.
Go to setting page: **Configuration** → **Video/Audio** → **Video**.



5.8.4 **Note**
For device with multiple camera channels, select a channel before other settings.

I. Stream Type

For device supports more than one stream, you can specify parameters for each stream type.

Main Stream

The stream stands for the best stream performance the device supports. It usually offers the best resolution and frame rate the device can do. But high resolution and frame rate usually means larger storage space and higher bandwidth requirements in transmission.

Sub Stream

The stream usually offers comparatively low resolution options, which consumes less bandwidth and storage space.

Other Streams

Streams other than the main stream and sub stream may also be offered for customized usage.

II. Video Type

Select the content (video and audio) that should be contained in the stream.

Video

Only video content is contained in the stream.

Video & Audio

Video content and audio content are contained in the composite stream.

III. Resolution

Select video resolution according to actual needs. Higher resolution requires higher bandwidth and storage.

IV. Bitrate Type and Max. Bitrate

Constant Bitrate

It means that the stream is compressed and transmitted at a comparatively fixed bitrate. The compression speed is fast, but mosaic may occur on the image.

Variable Bitrate

It means that the device automatically adjust the bitrate under the set **Max. Bitrate**. The compression speed is slower than that of the constant bitrate. But it guarantees the image quality of complex scenes.

V. Video Quality

When **Bitrate Type** is set as Variable, video quality is configurable. Select a video quality according to actual needs. Note that higher video quality requires higher bandwidth.

VI. Frame Rate

The frame rate is to describe the frequency at which the video stream is updated and it is measured by frames per second (fps). A higher frame rate is advantageous when there is movement in the video stream, as it maintains image quality throughout. Note that higher frame rate requires higher bandwidth and larger storage space.

VII. Video Encoding

It stands for the compression standard the device adopts for video encoding.



Note

Available compression standards vary according to device models.

- H.264

H.264, also known as MPEG-4 Part 10, Advanced Video Coding, is a compression standard. Without compressing image quality, it increases compression ratio and reduces the size of video file than MJPEG or MPEG-4 Part 2.

- H.265

H.265, also known as High Efficiency Video Coding (HEVC) and MPEG-H Part 2, is a compression standard. In comparison to H.264, it offers better video compression at the same resolution, frame rate and image quality.

- MJPEG

Motion JPEG (M-JPEG or MJPEG) is a video compression format in which intraframe coding technology is used. Images in a MJPEG format is compressed as individual JPEG images.

- Profile

This function means that under the same bitrate, the more complex the profile is, the higher the quality of the image is, and the requirement for network bandwidth is also higher.

- Frame Interval

I-frame interval defines the number of frames between 2 I-frames.

In H.264 and H.265, an I-frame, or intra frame, is a self-contained frame that can be independently decoded without any reference to other images. An I-frame consumes more bits than other frames. Thus, video with more I-frames, in other words, smaller I-frame interval, generates more steady and reliable data bits while requiring more storage space.

- SVC

Scalable Video Coding (SVC) is the name for the Annex G extension of the H.264 or H.265 video compression standard. The objective of the SVC standardization has been to enable the encoding of a high-quality video bitstream that contains one or more subset bitstreams that can themselves be decoded with a complexity and reconstruction quality similar to that achieved using the existing H.264 or H.265 design with the same quantity of data as in the subset bitstream. The subset bitstream is derived by dropping packets from the larger bitstream.

SVC enables forward compatibility for older hardware: the same bitstream can be consumed by basic hardware which can only decode a low-resolution subset, while more advanced hardware will be able decode high quality video stream.

VIII. Smoothing

It refers to the smoothness of the stream. The higher value of the smoothing is, the better fluency of the stream will be, though, the video quality may not be so satisfactory. The lower value of the smoothing is, the higher quality of the stream will be, though it may appear not fluent.

IX. Display VCA Info

VCA information can be displayed by Player and Video.

Player

Player means the VCA info can be displayed by the dedicated player provided by the manufacturer.

Video

Video means the VCA info can be displayed by any general video player.

X. Audio Settings

It is a function to set audio parameters such as audio encoding, environment noise filtering.

Go to the audio settings page: **Configuration** → **Video/Audio** → **Audio**.

● Audio Encoding

Select the audio encoding compression of the audio.

● Audio Input



Note

- Connect the audio input device as required.
 - The audio input display varies with the device models.
-

LineIn	Set Audio Input to LineIn when the device connects to the audio input device with the high output power, such as MP3, synthesizer or active pickup.
MicIn	Set Audio Input to MicIn when the device connects to the audio input device with the low output power, such as microphone or passive pickup.

● Environmental Noise Filter

Set it as OFF or ON. When the function is enabled, the noise in the environment can be filtered to some extent.





XI. Two-way Audio

It is used to realize the two-way audio function between the monitoring center and the target in the monitoring screen.

Before You Start

- Make sure the audio input device (pick-up or microphone) and audio output device (speaker) connected to the device is working properly. Refer to specifications of audio input and output devices for device connection.
- If the device has built-in microphone and speaker, two-way audio function can be enabled directly.

Steps

1. Click **Live View**.
2. Click  on the toolbar to enable two-way audio function of the camera.
3. Click  and select , move the slider to adjust the volume.
4. Click , disable the two-way audio function.

XII. Set ROI

ROI (Region of Interest) encoding helps to assigns more encoding resource to the region of interest, thus to increase the quality of the ROI whereas the background information is less focused.

Before You Start

Please check the video coding type. ROI is supported when the video coding type is H.264 or H.265.

Steps

1. Go to **Configuration** → **Video/Audio** → **ROI**.
2. Check **Enable**.
3. Select the channel No. according to your need.
4. Select **Stream Type**.
5. Select **Region No.** in **Fixed Region** to draw ROI region.
 - 1) Click **Drawing**.
 - 2) Click and drag the mouse on the view screen to draw the fixed region.
 - 3) Click **Stop Drawing**.



Select the fixed region that needs to be adjusted and drag the mouse to adjust its position.

6. Input the **Region Name** and **ROI Level**.
7. Click **Save**.



5.8.2 Display Settings
The higher the ROI level is, the clearer the image of the detected region is.

8. Optional: Select other region No. and repeat the above steps if you need to draw multiple fixed regions.

It offers the parameter settings to adjust image features.

Go to **Configuration** → **Image** → **Display Settings**.

For device that supports multiple channels, display settings of each channel is required.

Click **Default** to restore settings.

I. Image Adjustment

By adjusting the **Brightness, Saturation, Contrast** and **Sharpness**, the image can be best displayed.

II. Image Adjustment (Thermal Channel)

You can optimize the image display effect of thermal channel by setting background correction and manual correction.

Background Correction

Fully cover the lens with an object of uniform temperature in front of the lens, such as foam board or paperboard. When you click **Correct**, the device will take the uniform object as the standard and optimize the image once.

Manual Correction

Click **Correct** to optimize the image once.



Note

It is a normal phenomenon that short video freezing might occur during the process of **Background Correction** and **Manual Correction**.

Thermal AGC Mode

Choose the AGC mode according to different scenes to balance and improve the image quality.

- Histogram: Choose for scene with obvious WDR and high temperature difference, can improve image contrast and enhance image. E.g. the scene contains both indoor and outdoor scenes.
- Linear: Choose for scene with low temperature difference and the target is not obvious, can improve image contrast and enhance image. E.g. the bird in forest.
- Self-Adaptive: Choose AGC mode automatically according to current scene.

III. Exposure Settings

Exposure is controlled by the combination of iris, shutter, and photo sensibility. You can adjust image effect by setting exposure parameters.

In manual mode, you need to set **Exposure Time, Gain** and **Slow Shutter**.

IV. Day/Night Switch

Day/Night Switch function can provide color images in the day mode and black/white images in the night mode. Switch mode is configurable.

Day

The image is always in color.

Night

The image is always black/white

Auto

The camera switches between the day mode and the night mode according to the illumination automatically.

Scheduled-Switch

Set the **Start Time** and the **End Time** to define the duration for day mode.



Day/Night Switch function varies according to models.

V. Set Supplement Light

Steps

1. Go to **Configuration** → **Maintenance** → **System Service**.
2. Check **Enable Supplement Light**.
3. Click **Save**.
4. Go to **Configuration** → **Image** → **Display Settings** → **Day/Night Switch** to set supplement light parameters.

Smart Supplement Light

This feature uses smart image processing technology to reduce overexposure caused by supplement light.

IR Light Mode

When the mode is set to **Auto**, the supplement light is automatically enabled or disabled according to the image brightness.

Brightness Limit

Adjust the upper limit of IR light power.

VI. BLC

If you focus on an object against strong backlight, the object will be too dark to be seen clearly. BLC (backlight compensation) compensates light to the object in the front to make it clear. If BLC mode is set as **Custom**, you can draw a red rectangle on the live view image as the BLC area.

VII. WDR

The WDR (Wide Dynamic Range) function helps the camera provide clear images in environment with strong illumination differences. When there are both very bright and very dark areas simultaneously in the field of view, you can enable the WDR function and set the level. WDR automatically balances the brightness level of the whole image and provides clear images with more details.



When WDR is enabled, some other functions may be not supported. Refer to the actual interface for details.

VIII. White Balance

White balance is the white rendition function of the camera. It is used to adjust the color temperature according to the environment.

IX. DNR

Digital Noise Reduction is used to reduce the image noise and improve the image quality. **Normal** and **Expert** modes are selectable.

Normal

Set the DNR level to control the noise reduction degree. The higher level means stronger reduction degree.

Expert

Set the DNR level for both space DNR and time DNR to control the noise reduction degree. The higher level means stronger reduction degree.

X. Set Palette

You can select the palette mode to display the thermal grayscale image to colored image.

Steps

1. Go to **Configuration** → **Image** → **Display Settings**.
2. Select the thermal channel.
3. Select a palette mode in **Image Enhancement** according to your need.

Result

The live view displays the image with palette.

XI. Set Target Color

You can set the color of the targets in different temperature ranges to identify the target quickly.

Steps

1. Go to **Configuration** → **Image** → **Display Settings**.
2. Select the thermal channel.
3. Click **Image Enhancement**, select **Palette** as **White Hot** or **Black Hot**.
4. Set the temperature value and color of **High Temperature**, **Interval Temperature**, or **Low Temperature** targets.

^ Image Enhancement

Digital Noise Reduction

Noise Reduction Level

Palettes

Above (be colored)

Max °C

Color

Between (be colored)

Min °C

Max °C

Color

Below (be colored)

Max °C

Color

Note: Click button to save the settings.

DDE

DDE Level

Brightness Sudden Chan...

Target Enhancement

Figure 9-1 Set the Temperature and Color of Target

Above (be colored)

When the target of high temperature needs to be colored, you can set the high temperature color. Target above the setting temperature will be displayed in setting color.

Between (be colored)

When the target of an interval temperature needs to be colored, you can set the interval temperature color. Target between the minimum and the maximum temperatures will be displayed in setting color.

Below (be colored)

When the target of low temperature needs to be colored, you can set the low temperature color. Target below the setting temperature will be displayed in setting color.

5. Click **Save**.

XII. DDE

Digital Detail Enhancement is used to adjust the details of the image. **OFF** and **Normal** modes are selectable.

OFF

Disable this function.

Normal

Set the DDE level to control the details of the image. The higher the level is, the more details shows, but the higher the noise is.

XIII. Brightness Sudden Change

When the brightness of target and the background is hugely different (the temperature difference of target and background is huge), the system reduces the difference for viewing.

XIV. Enhance Regional Image

You can select the desired area of image to improve the coding quality. The regional image will be more detailed and clear.

Steps

1. Go to **Configuration** → **Image** → **Display Settings** → **Image Enhancement**.
2. Select the area of regional image enhancement. You can select **OFF** to disable this function, or select **Custom Area** to draw a desired area.
A red rectangle shows on the display, in which the image quality is improved.

XV. Mirror

When the live view image is the reverse of the actual scene, this function helps to display the image normally. Select the mirror mode as needed.



Note

The video recording will be shortly interrupted when the function is enabled.

XVI. Video Standard

Video standard is an ability of a video card or video display device that defines the amount of colors that are shown and the resolution. The two most common video standard used are NTSC and PAL. In NTSC, 30 frames are transmitted each second. Each frame is made up of 525 individual scan lines. In PAL, 25 frames are transmitted each second. Each frame is made up of 625 individual scan lines. Select video signal standard according to the video system in your country.

XVII. Digital Zoom

You can zoom in the image
The larger the zoom size is, the more blurred the image is.

You can customize OSD (On-screen Display) information such as device name, time/date, font, color, and text overlay displayed on video stream.

Go to OSD setting page: **Configuration** → **Image** → **OSD Settings**. Set the corresponding parameters, and click **Save** to take effect.

Displayed Information

5.8.3.1 Set camera name, date, week, and their related display format.

Text Overlay

Set customized overlay text on image.

OSD Parameters

Set OSD parameters, such as **Display Mode**, **OSD Size**, and **Font Color**.

The function blocks certain areas in the live view to protect privacy. No matter how the device moves, the blocked scene will never be seen.

5.8.4 Set Privacy Mask

Steps

1. Go to privacy mask setting page: **Configuration** → **Image** → **Privacy Mask**.
2. Select the channel No.
3. Check **Enable Privacy Mask**.
4. Click **Draw Area**. Drag the mouse in the live view to draw a closed area.

Drag the corners of the area Adjust the size of the area.

Drag the area Adjust the position of the area.

Click Clear All Clear all the areas you set.

5. Click **Stop Drawing**.

6. Click **Save**.



Up to 4 areas are supported for setting.

5.8.5.5 Overlay Picture

Overlay a customized picture on live view.

Before You Start



The picture to overlay has to be in BMP format with 24-bit, and the maximum picture size is 128 × 128 pixel.

Steps



1. Go to picture overlay setting page: **Configuration** → **Image** → **Picture Overlay**.
2. Select a channel to overlay picture.
3. Click **Browse** to select a picture, and click **Upload**.
The picture with a red rectangle will appear in live view after successfully uploading.
4. Check **Enable Picture Overlay**.
5. Drag the picture to adjust its position.
6. Click **Save**.

If the amount of defective pixels in the image is comparatively small and accurate correction is needed, you can correct these pixels manually.

Steps

1. Go to **Configuration** → **Image** → **DPC**.
2. Select the thermal channel.
- 5.8.6 **Set Manual DPC (Defective Pixel Correction)**
4. Click the defective pixel on the image, then a cursor shows on the live view.
5. Click **Up, Down, Left, Right** to adjust the cursor position to the defective pixel position.
6. Click , then click  to correct defective pixel.



If multiple defective pixels need to be corrected, click  after locating a defective pixel. Then after locating other pixels, click  to correct them simultaneously.

7. Optional: Click  to cancel defective pixel correction.

5.8.7 **Set Picture in Picture** You can overlay the images of two channels and view the image of two channels at the same time.

Steps

1. Select a channel number.
2. Select the picture in picture mode.

Normal Mode

Disable picture in picture mode.

Overlay Mode

Enable picture in picture mode. You can overlay the image of another channel in the current channel.

3. Click **Save**.

Video Recording and Picture Capture

This part introduces the operations of capturing video clips and snapshots, playback, and downloading captured files.

5.9 This part introduces the configuration of several common storage paths.

I. Set Memory Card

5.9.1 Storage Settings

If you choose to store the files to memory card, make sure you insert and format the memory card in advance.

Before You Start

Insert the memory card to the camera. For detailed installation, refer to *Quick Start Guide* of the camera.

Steps

1. Go to storage management setting page: **Configuration** → **Storage** → **Storage Management** → **HDD Management**.
2. Select the memory card, and click **Format** to start initializing the memory card.
The **Status** of memory card turns to **Normal** from **Uninitialized**, which means the memory card can be used normally.
3. Optional: Define the **Quota** of the memory card. Input the quota percentage for different contents according to your need.
4. Click **Save**.

II. Set NAS

Take network server as network disk to store the record files, captured images, etc.

Before You Start

Get the IP address of the network disk first.

Steps

1. Go to NAS setting page: **Configuration** → **Storage** → **Storage Management** → **Net HDD**.
2. Click **HDD No.** Select **Mounting Type** and set parameters for the disk.

Server Address

The IP address of the network disk.

File Path

The saving path of network disk files.

User Name and Password

The user name and password of the net HDD.

3. Click **Test** to check whether the network disk is available.
4. Click **Save**.

III. Set FTP

You can configure the FTP server to save images which are captured by events or a timed snapshot task.

Before You Start

Get the FTP server address first.

Steps

1. Go to **Configuration** → **Network** → **Advanced Settings** → **FTP**.
2. Configure FTP settings.

Server Address and Port

The FTP server address and corresponding port.

User Name and Password

The FTP user should have the permission to upload pictures.

If the FTP server supports picture uploading by anonymous users, you can check **Anonymous** to hide your device information during uploading.

Directory Structure

The saving path of snapshots in the FTP server.

3. Click **Upload Picture** to enable uploading snapshots to the FTP server.
4. Click **Test** to verify the FTP server.
5. Click **Save**.

IV. Set Cloud Storage

It helps to upload the captured pictures and data to the cloud. The platform requests picture directly from the cloud for picture and analysis. The function is only supported by certain models.

Steps



If cloud storage is enabled, the pictures are stored in the cloud storage server preferentially.

1. Go to **Configuration** → **Storage** → **Storage Management** → **Cloud Storage**.
2. Check **Enable Cloud Storage**.
3. Set basic parameters.

Protocol Version	The protocol version of the cloud storage server.
Server IP	The IP address of the cloud storage server. It supports IPv4 address.
Serve Port	The port of the cloud storage server. 6001 is the default port and you are not recommended to edit it.
User Name and Password	The user name and password of the cloud storage server.
Picture Storage Pool ID	The ID of the picture storage region in the cloud storage server. Make sure storage pool ID and the storage region ID are the same.

4. Click **Test** to test the configured settings.
5. Click **Save**.

This part introduces the operations of manual and scheduled recording, playback, and downloading recorded files.

I. Record Automatically

5.9.2 Video Recording

This function can record video automatically during configured time periods.

Before You Start

Select **Trigger Recording** in event settings for each record type except **Continuous**. See **Event and Alarm** for details.

Steps

1. Go to **Configuration** → **Storage** → **Schedule Settings** → **Record Schedule**.
2. Select channel No.
3. Check **Enable**.
4. Select a record type.



Note

The record type is vary according to different models.

Continuous

The video will be recorded continuously according to the schedule.

Motion

When motion detection is enabled and trigger recording is selected as linkage method, object movement is recorded.

Alarm

When alarm input is enabled and trigger recording is selected as linkage method, the video is recorded after receiving alarm signal from external alarm input device.

Motion | Alarm

Video is recorded when motion is detected or alarm signal is received from the external alarm input device.

Motion & Alarm

Video is recorded only when motion is detected and alarm signal is received from the external alarm input device.

Event

The video is recorded when configured event is detected.

5. Set schedule for the selected record type. Refer to **Set Arming Schedule** for the setting operation.
6. Click **Advanced** to set the advanced settings.

Overwrite

Enable **Overwrite** to overwrite the video records when the storage space is full. Otherwise the camera cannot record new videos.

Pre-record

The time period you set to record before the scheduled time.

Post-record

The time period you set to stop recording after the scheduled time.

Stream Type

Select the stream type for recording.





When you select the stream type with higher bitrate, the actual time of the pre-record and post-record may be less than the set value.

7. Click **Save**.

II. Record Manually



Steps

1. Go to **Configuration** → **Local**.
2. Set the **Record File Size** and saving path to for recorded files.
3. Click **Save**.
4. Click  to start recording. Click  to stop recording.

III. Playback and Download Video

You can search, playback and download the videos stored in the local storage or network storage.

Steps

1. Click **Playback**.
2. Select channel No.
3. Set search condition and click **Search**.
The matched video files showed on the timing bar.
4. Click  to play the video files.
 - Click  to clip video files.
 - Click  to play video files in full screen. Press **ESC** to exit full screen.



Go to **Configuration** → **Local**, click **Save clips to** to change the saving path of clipped video files.

5. Click  on the playback interface to download files.
 - 1) Set search condition and click **Search**.
 - 2) Select the video files and then click **Download**.



5.9.3 Capture Configuration → **Local**, click **Save downloaded files to** to change the saving path of downloaded video files.

The device can capture the pictures manually or automatically and save them in configured saving path. You can view and download

the snapshots.

I. Capture Automatically

This function can capture pictures automatically during configured time periods.

Before You Start

If event-triggered capture is required, you should configure related linkage methods in event settings. Refer to *Event and Alarm* for event settings.

Steps

1. Go to **Configuration** → **Storage** → **Schedule Settings** → **Capture** → **Capture Parameters**.
2. Set the capture type.

Timing

Capture a picture at the configured time interval.

Event-Triggered

Capture a picture when an event is triggered.

3. Set the **Format**, **Resolution**, **Quality**, **Interval**, and **Capture Number**.
4. Refer to *Set Arming Schedule* for configuring schedule time.
5. Click **Save**.

II. Capture Manually

Steps

1. Go to **Configuration** → **Local**.
2. Set the **Image Format** and saving path to for snapshots.

JPEG

The picture size of this format is comparatively small, which is better for network transmission.

BMP

The picture is compressed with good quality.

3. Click **Save**.
4. Click  near the live view or play back window to capture a picture manually.

III. View and Download Picture

You can search, view and download the pictures stored in the local storage or network storage.

Steps

1. Click **Picture**.
2. Select channel No.
3. Set search condition and click **Search**.
The matched pictures showed in the file list.
4. Select the pictures then click **Download** to download them.



Go to **Configuration** → **Local**, click **Save snapshots when playback** to change the saving path of pictures.

Network Settings

TCP/IP settings must be properly configured before you operate the device over network. IPv4 and IPv6 are both supported. Both versions can be configured simultaneously without conflicting to each other.

5.10.10 Go to **Configuration** → **Basic Configuration** → **Network** → **TCP/IP** for parameter settings.

NIC Type

5.10.11 Select a NIC (Network Interface Card) type according to your network condition.

IPv4

Two IPv4 modes are available.

DHCP

The device automatically gets the IPv4 parameters from the network if you check **DHCP**. The device IP address is changed after enabling the function. You can use SADP to get the device IP address.



Note

The network that the device is connected to should support DHCP (Dynamic Host Configuration Protocol).

Manual

You can set the device IPv4 parameters manually. Input **IPv4 Address**, **IPv4 Subnet Mask**, and **IPv4 Default Gateway**, and click **Test** to see if the IP address is available.

IPv6

Three IPv6 modes are available.

Route Advertisement

The IPv6 address is generated by combining the route advertisement and the device Mac address.



Note

Route advertisement mode requires the support from the router that the device is connected to.

DHCP

The IPv6 address is assigned by the server, router or gateway.

Manual

Input **IPv6 Address**, **IPv6 Subnet**, **IPv6 Default Gateway**. Consult the network administrator for required information.

MTU

It stands for maximum transmission unit. It is the size of the largest protocol data unit that can be communicated in a single network layer transaction.

The valid value range of MTU is 1280 to 1500.

DNS

It stands for domain name server. It is required if you need to visit the device with domain name. And it is also required for some applications (e.g., sending email). Set **Preferred DNS Server** and **Alternate DNS server** properly if needed.

Multicast Discovery

Check the **Enable Multicast Discovery**, and then the online network camera can be automatically detected by client software via private multicast protocol in the LAN.

The device port can be modified when the device cannot access the network due to port conflicts.



Caution

Do not modify the default port parameters at will, otherwise the device may be inaccessible.

5.10.2 Port Configuration → Network → Basic Settings → Port for port settings.

HTTP Port

It refers to the port that access the device through the browser. You should enter the port No. after the IP address. For example, when the **HTTP port** is modified to 81, you need to enter **http://192.168.1.64:81** in the browser for browser login.

HTTPS Port

It refers to the port of browser certificate access. Certificate verification is required when accessing the device through the browser, and the security level is high.

RTSP Port

It refers to the port of real time streaming protocol.

Server Port

It refers to the port on which the client adds the device.

5.10.3 Port Mapping

By setting port mapping, you can access devices through the specified port.

Before You Start

When the ports in the device are the same as those of other devices in the network, refer to **Port** to modify the device ports.

Steps

1. Go to **Configuration** → **Network** → **Basic Settings** → **NAT**.
2. Select the port mapping mode.

Auto Port Mapping Refer to **Set Auto Port Mapping** for detailed information.

Manual Port Mapping Refer to **Set Manual Port Mapping** for detailed information.

3. Click **Save**.

I. Set Auto Port Mapping

Steps

1. Check **Enable UPnP™**, and choose a friendly name for the camera, or you can use the default name.
2. Select the port mapping mode to **Auto**.
3. Click **Save**.



Note

UPnP™ function on the router should be enabled at the same time.

II. Set Manual Port Mapping

Steps

1. Check **Enable UPnP™**, and choose a friendly name for the device, or you can use the default name.
2. Select the port mapping mode to **Manual**, and set the external port to be the same as the internal port.
3. Click **Save**.

What to do next

Go to the router port mapping settings interface and set the port number and IP address to be the same as those on the device. For more information, refer to the router user manual.

Multicast is group communication where data transmission is addressed to a group of destination devices simultaneously. After setting multicast, you can send the source data efficiently to multiple receivers.

- 5.10.4 Multicast
- Go to **Configuration** → **Network** → **Basic Settings** → **Multicast** for the multicast settings.

IP Address

It stands for the address of multicast host.

Stream Type

The stream type as the multicast source.

Video Port

The video port of the selected stream.

Audio Port

The audio port of the selected stream.

5.10.5SNMP

You can set the SNMP network management protocol to get the alarm event and exception messages in network transmission.

Before You Start

Before setting the SNMP, you should download the SNMP software and manage to receive the device information via SNMP port.

Steps

1. Go to the settings page: **Configuration** → **Network** → **Advanced Settings** → **SNMP**.
2. Check **Enable SNMPv1**, **Enable SNMP v2c** or **Enable SNMPv3**.



The SNMP version you select should be the same as that of the SNMP software.

And you also need to use the different version according to the security level required. SNMP v1 is not secure and SNMP v2 requires password for access. And SNMP v3 provides encryption and if you use the third version, HTTPS protocol must be enabled.

5.10.6 Access to Device via Domain Name

3. Configure the SNMP settings.
4. Click **Save**.

You can use the Dynamic DNS (DDNS) for network access. The dynamic IP address of the device can be mapped to a domain name

resolution server to realize the network access via domain name.

Before You Start

Registration on the DDNS server is required before configuring the DDNS settings of the device.

Steps

1. Refer to **TCP/IP** to set DNS parameters.
2. Go to the DDNS settings page: **Configuration** → **Network** → **Basic Settings** → **DDNS**.
3. Check **Enable DDNS** and select **DDNS type**.

DynDNS

Dynamic DNS server is used for domain name resolution.

NO-IP

NO-IP server is used for domain name resolution.

4. Input the domain name information, and click **Save**.
5. Check the device ports and complete port mapping. Refer to **Port** to check the device port , and refer to **Port Mapping** for port mapping settings.
6. Access the device.

By Browsers

Enter the domain name in the browser address bar to access the device.

By Client Software

Add domain name to the client software. Refer to the client manual for specific adding methods.

5.10.7 Access to Device via PPPoE Dial Up Connection

This device supports the PPPoE auto dial-up function. The device gets a public IP address by ADSL dial-up after the device is connected to a modem. You need to configure the PPPoE parameters of the device.

Steps

1. Go to **Configuration** → **Network** → **Basic Settings** → **PPPoE**.
2. Check **Enable PPPoE**.
3. Set the PPPoE parameters.

Dynamic IP

After successful dial-up, the dynamic IP address of the WAN is displayed.

User Name

User name for dial-up network access.

Password

Password for dial-up network access.

Confirm

Input your dial-up password again.

4. Click **Save**.
5. Access the device.

By Browsers

Enter the WAN dynamic IP address in the browser address bar to access the device.

By Client Software

Add the WAN dynamic IP address to the client software. Refer to the client manual for details.



The obtained IP address is dynamically assigned via PPPoE, so the IP address always changes after rebooting the camera. To solve the inconvenience of the dynamic IP, you need to get a domain name from the DDNS provider (e.g. DynDns.com). Refer to **Access to Device via Domain Name** for detail information.

Hik-Connect service should be enabled on your camera before using the service.
You can enable the service through SADP software or Web browser.

5.1.1.8 Enable Hik-Connect Service via Web Browser

Follow the following steps to enable Hik-Connect Service via Web Browser.

Before You Start

You need to activate the camera before enabling the service.

Steps

1. Access the camera via web browser.
2. Enter platform access configuration interface. **Configuration** → **Network** → **Advanced Settings** → **Platform Access**
3. Select Hik-Connect as the **Platform Access Mode**.
4. Check **Enable**.
5. Click and read "Terms of Service" and "Privacy Policy" in pop-up window.
6. Create a verification code or change the old verification code for the camera.



The verification code is required when you add the camera to Hik-Connect service.

7. Save the settings.

II. Enable Hik-Connect Service via SADP Software

This part introduce how to enable Hik-Connect service via SADP software of an activated camera.

Steps

1. Run SADP software.
2. Select a camera and enter **Modify Network Parameters** page.
3. Check **Enable Hik-Connect**.
4. Create a verification code or change the old verification code.



The verification code is required when you add the camera to Hik-Connect service.

5. Click and read "Terms of Service" and "Privacy Policy".
6. Confirm the settings.

III. Access Camera via Hik-Connect

Hik-Connect is an application for mobile devices. Using the App, you can view live image, receive alarm notification and so on.

Steps

1. Download and install the Hik-Connect app by searching "Hik-Connect" in App Store or Google Play^(TM)
2. Launch the app and register for a Hik-Connect user account.
3. Log in after registration.
4. In the app, tap "+" on the upper-right corner and then scan the QR code of the camera to add the camera. You can find the QR code on the camera or on the cover of the Quick Start Guide of the camera in the package.
5. Follow the prompts to set the network connection and add the camera to your Hik-Connect account.

For detailed information, refer to the user manual of the Hik-Connect app.

When the device is registered on ISUP platform (formerly called Ehome), you can visit and manage the device, transmit data, and forward alarm information over public network.

5.10.9 Set ISUP

Steps

1. Go to **Configuration** → **Network** → **Advanced Settings** → **Platform Access**.
2. Select **ISUP** as the platform access mode.
3. Select **Enable**.
4. Select a protocol version and input related parameters.
5. Click **Save**.

Register status turns to **Online** when the function is correctly set.

5.10.10 Set ONVIF

If you need to access to the device through ONVIF protocol, you can configure the ONVIF user to enhance the network security.

Steps

1. Go to **Configuration** → **Network** → **Advanced Settings** → **Integration Protocol**.
2. Check **Enable ONVIF**.
3. Click **Add** to configure the ONVIF user.

Delete Delete the selected ONVIF user.

Modify Modify the selected ONVIF user.

5.10.11 Set HTTP Listening

4. Click **Save**.
5. Optional: Repeat the steps above to add more ONVIF users.

The device can send alarms to destination IP or host name through HTTP protocol. The destination IP or host name should support the HTTP data transmission.

Steps

1. Go to **Configuration** → **Network** → **Advanced Settings** → **HTTP Listening**.
2. Input **Destination IP** or **Host Name**, **URL**, and **Port**.
3. Click **Test**.



Click **Default** to reset the destination IP or host name.

4. Click **Save**.

System and Security

It introduces system maintenance, system settings and security management, and explains how to configure relevant parameters.

- 5.11 You can view device information, such as Device No., Model, Serial No. and Firmware Version.
Enter **Configuration** → **System** → **System Settings** → **Basic Information** to view the device information.

5.11.1 View Device Information

Log helps locate and troubleshoot problems.

Steps

- 5.11.1.2 Search Configuration
1. Go to **Configuration** → **System** → **Maintenance** → **Log**.
 2. Set search conditions **Major Type**, **Minor Type**, **Start Time**, and **End Time**.
 3. Click **Search**.
The matched log files will be displayed on the log list.
 4. Optional: Click **Export** to save the log files in your computer.

- 5.11.3 Import and Export Configuration File
It helps speed up batch configuration on other devices with the same parameters.

Steps

1. Export configuration file.
 - 1) Go to **Configuration** → **System** → **Maintenance** → **Upgrade & Maintenance**.
 - 2) Click **Device Parameters** and input the encryption password to export the current configuration file.
 - 3) Set the saving path to save the configuration file in local computer.
2. Import configuration file.
 - 1) Access the device that needs to be configured via web browser.
 - 2) Click **Browse** to select the saved configuration file.
 - 3) Input the encryption password you have set when exporting the configuration file.
 - 4) Click **Import**.

5.11.4 Export Diagnose Information

Diagnose information includes running log, system information, hardware information.

- 5.11.5 Reboot
Go to **Configuration** → **System** → **Maintenance** → **Upgrade & Maintenance**, and click **Diagnose Information** to export diagnose information of the device.

5.11.6 Restore and Default

You can reboot the device via browser.

Go to **Configuration** → **System** → **Maintenance** → **Upgrade & Maintenance**, and click **Reboot**.

Restore and Default helps restore the device parameters to the default settings.

Steps

1. Go to **Configuration** → **System** → **Maintenance** → **Upgrade & Maintenance**.

2. Click **Restore** or **Default** according to your needs.

Restore Reset device parameters, except user information, IP parameters and video format to the default settings.

Default Reset all the parameters to the factory default.



Note

Be careful when using this function. After resetting to the factory default, all the parameters are reset to the default settings.

Before You Start

5.11.7 Upgrade You need to obtain the correct upgrade package.



Caution

DO NOT disconnect power during the process, and the device reboots automatically after upgrade.

Steps

1. Go to **Configuration** → **System** → **Maintenance** → **Upgrade & Maintenance**.
2. Choose one method to upgrade.

Firmware Locate the exact path of the upgrade file.

Firmware Directory Locate the directory which the upgrade file belongs to.

3. Click **Browse** to select the upgrade file.
4. Click **Upgrade**.

5.11.8 View Open Source Software License

5.11.9 Time and Date Go to **Configuration** → **System** → **System Settings** → **About Device**, and click **View Licenses**.

You can configure time and date of the device by configuring time zone, time synchronization and Daylight Saving Time (DST).

I. Synchronize Time Manually

Steps

1. Go to **Configuration** → **System** → **System Settings** → **Time Settings**.
2. Select **Time Zone**.
3. Click **Manual Time Sync..**
4. Choose one time synchronization method.
 - Select **Set Time**, and manually input or select date and time from the pop-up calendar.Check **Sync. with computer time** to synchronize the time of the device with that of the local PC.

5. Click **Save**.

II. Set NTP Server

You can use NTP server when accurate and reliable time source is required.

Before You Start

Set up a NTP server or obtain NTP server information.

Steps

1. Go to **Configuration** → **System** → **System Settings** → **Time Settings**.
2. Select **Time Zone**.
3. Click **NTP**.
4. Set **Server Address**, **NTP Port** and **Interval**.



Note

Server Address is NTP server IP address.

5. Click **Test** to test server connection.
6. Click **Save**.

III. Set DST

If the region where the device is located adopts Daylight Saving Time (DST), you can set this function.

Steps

1. Go to **Configuration** → **System** → **System Settings** → **DST**.
2. Check **Enable DST**.
3. Select **Start Time**, **End Time** and **DST Bias**.
4. Click **Save**.

5.11.10 Set RS-232

RS-232 can be used to debug device or access peripheral device. RS-232 can realize communication between the device and computer or terminal when the communication distance is short.

Before You Start

Connect the device to computer or terminal with RS-232 cable.

Steps

1. Go to **Configuration** → **System** → **System Settings** → **RS-232**.
2. Set RS-232 parameters to match the device with computer or terminal.
3. Click **Save**.

RS-485 is used to connect the device to external device. You can use RS-485 to transmit the data between the device and the computer or terminal when the communication distance is too long.

Before You Start

Connect the device and computer or terminal with RS-485 cable.

Steps

1. Go to **Configuration** → **System** → **System Settings** → **RS-485**.
2. Set the RS-485 parameters.



You should keep the parameters of the device and the computer or terminal all the same.

3. Click **Save**.

Set the same temperature unit and distance unit. When you enable this function, the unit cannot be configured separately in other setting pages

5.11.12 Set Same Unit

1. Go to **Configuration** → **System** → **System Settings** → **Unit Settings**.
2. Check **Use Same Unit**.
3. Set the temperature unit and distance unit.
4. Click **Save**.

5.11.13 Security

You can improve

I. Authentication

You can improve network access security by setting RTSP and WEB authentication.

Go to **Configuration** → **System** → **Security** → **Authentication** to choose authentication protocol and method according to your needs.

RTSP Authentication

Digest and digest/basic are supported, which means authentication information is needed when RTSP request is sent to the device. If you select **digest/basic**, it means the device supports digest or basic authentication. If you select **digest**, the device only supports digest authentication.

RTSP Digest Algorithm

MD5, SHA256 and MD5/SHA256 encrypted algorithm in RTSP authentication. If you enable the digest algorithm except for MD5, the third-party platform might not be able to log in to the device or enable live view because of compatibility. The encrypted algorithm with high strength is recommended.

WEB Authentication

Digest and digest/basic are supported, which means authentication information is needed when WEB request is sent to the device. If you select **digest/basic**, it means the device supports digest or basic authentication. If you select **digest**, the device only supports digest authentication.

WEB Digest Algorithm

MD5, SHA256 and MD5/SHA256 encrypted algorithm in WEB authentication. If you enable the digest algorithm except for MD5, the third-party platform might not be able to log in to the device or enable live view because of compatibility. The encrypted algorithm with high strength is recommended.



Refer to the specific content of protocol to view authentication requirements.

II. Security Audit Log

The security audit logs refer to the security operation logs. You can search and analyze the security log files of the device so as to find out the illegal intrusion and troubleshoot the security events.

Security audit logs can be saved on device internal storage. The log will be saved every half hour after device booting. Due to limited storage space, you can also save the logs on a log server.

Search Security Audit Logs

You can search and analyze the security log files of the device so as to find out the illegal intrusion and troubleshoot the security events.

Steps



This function is only supported by certain camera models.

1. Go to **Configuration** → **System** → **Maintenance** → **Security Audit Log**.

2. Select log types, **Start Time**, and **End Time**.

3. Click **Search**.

The log files that match the search conditions will be displayed on the Log List.

4. Optional: Click **Export** to save the log files to your computer.

III. Set IP Address Filter

IP address filter is a tool for access control. You can enable the IP address filter to allow or forbid the visits from the certain IP addresses.

IP address refers to IPv4.

Steps

1. Go to **Configuration** → **System** → **Security** → **IP Address Filter**.

2. Check **Enable IP Address Filter**.

3. Select the type of IP address filter.

Forbidden IP addresses in the list cannot access the device.

Allowed Only IP addresses in the list can access the device.

4. Edit the IP address filter list.

Add Add a new IP address to the list.

Modify Modify the selected IP address in the list.

Delete Delete the selected IP address in the list.

5. Click **Save**.

IV. Set SSH

SSH is a protocol to ensure security of remote login. This setting is reserved for professional maintenance personnel only.

Steps

1. Go to **Configuration** → **System** → **Security** → **Security Service**.
2. Check **Enable SSH**.
3. Click **Save**.

V. Set HTTPS

HTTPS is a network protocol that enables encrypted transmission and identity authentication, which improves the security of remote access.

Steps

1. Go to **Configuration** → **Network** → **Advanced Settings** → **HTTPS**.
2. Check **Enable**.
3. Click **Delete** to recreate and install certificate.

Create and install self-signed certificate Refer to *Create and Install Self-signed Certificate*

Create certificate request and install certificate Refer to *Install Authorized Certificate*

4. Click **Save**.

Create and Install Self-signed Certificate

Steps

1. Check **Create Self-signed Certificate**.
2. Click **Create**.
3. Follow the prompt to enter **Country, Hostname/IP, Validity** and other parameters.
4. Click **OK**.

Result

The device will install the self-signed certificate by default.

Install Authorized Certificate

If the demand for external access security is high, you can create and install authorized certificate via HTTPS protocol to ensure the data transmission security.

Steps

1. Select **Create certificate request first and continue the installation**.
2. Click **Create**.
3. Follow the prompt to input **Country, Hostname/IP, Validity** and other parameters.
4. Click **Download** to download the certificate request and submit it to the trusted authority for signature.
5. Import certificate to the device.
 - Select **Signed certificate is available, start the installation directly**. Click **Browse** and **Install** to import the certificate to the device.
 - Select **Create the certificate request first and continue the installation**. Click **Browse** and **Install** to import the certificate to the device.
6. Click **Save**.

VI. Set QoS

QoS (Quality of Service) can help improve the network delay and network congestion by setting the priority of data sending.



QoS needs support from network device such as router and switch.

Steps

1. Go to **Configuration** → **Network** → **Advanced Configuration** → **QoS**.
2. Set **Video/Audio DSCP**, **Alarm DSCP** and **Management DSCP**.



Network can identify the priority of data transmission. The bigger the DSCP value is, the higher the priority is. You need to set the same value in router while configuration.

3. Click **Save**.

VII. Set IEEE 802.1X

You can authenticate user permission of the connected device by setting IEEE 802.1X.

Go to **Configuration** → **Network** → **Advanced Settings** → **802.1X**, and enable the function.

Select protocol and version according to router information. User name and password of server are required.

5.11.14 User and Account

Set User Account and Permission

The administrator can add, modify, or delete other accounts, and grant different permission to different user levels.



To increase security of using the device on the network, please change the password of your account regularly. Changing the password every 3 months is recommended. If the device is used in high-risk environment, it is recommended that the password should be changed every month or week.

Steps

1. Go to **Configuration** → **System** → **User Management** → **User Management**.
2. Click **Add**. Enter **User Name**, select **Level**, and enter **Password**. Assign remote permission to users based on needs.

Administrator

The administrator has the authority to all operations and can add users and operators and assign permission.

User

Users can be assigned permission of viewing live video, setting PTZ parameters, and changing their own passwords, but no permission for other operations.

Operator

Operators can be assigned all permission except for operations on the administrator and creating accounts.

Modify

Select a user and click **Modify** to change the password and permission.

Delete

Select a user and click **Delete**.



The administrator can add up to 31 user accounts.

3. Click **OK**.

Appendix

FAQ

No.	Symptom	Description	Possible Reason	Solution	Tool
1	Unable to Boot	The device cannot be normally started after installation	1. Check whether the power cord between the main chassis and the detection door plate and the AC220V power cord between the door plate and the detection door plate are properly plugged. 2. Check whether the power cord is damaged, broken, bad contact, etc., and whether the power supply of the main chassis is normal.	1. Main board fault 2. Circuit fault	Manual operation
2	Screen off	The LCD screen or digital board are off	Check whether the connecting wire of the connecting panel of the main board is properly plugged.	Replace cable, display, and digital board.	Manual operation
3	No people counting	The number of people displayed as 0001 or 0000.	Open the camera of mobile phone. Make the lens align with the dot on the door plate. If the dot keeps flashing red, the infrared emission is normal. And if there is no flashing red dot, the infrared does not work properly.	Replace the infrared component	Manual operation
4	False Alarm	The alarm is triggered when there is no people walk through	1. Check whether the environment around the detector affects. Change the frequency. 2. There is direct sunlight on the infrared component.	1. Replace the infrared component 2. Replace installation place	Manual operation
5	Omitting alarm	No alarm when walk through the detector with metal	The sensitivity is too low.	Adjust the collection card	Manual operation

Common Material Emissivity Reference

Material	Emissivity
Human Skin	0.98
Printed Curcuit Board	0.91
Concrete	0.95
Ceramic	0.92
Rubber	0.95
Paint	0.93

Material	Emissivity
Wood	0.85
Pitch	0.96
Brick	0.95
Sand	0.90
Soil	0.92
Cloth	0.98
Hard Paperboard	0.90
White Paper	0.90
Water	0.96

18 Zones

Detector Zone Schematic Diagram

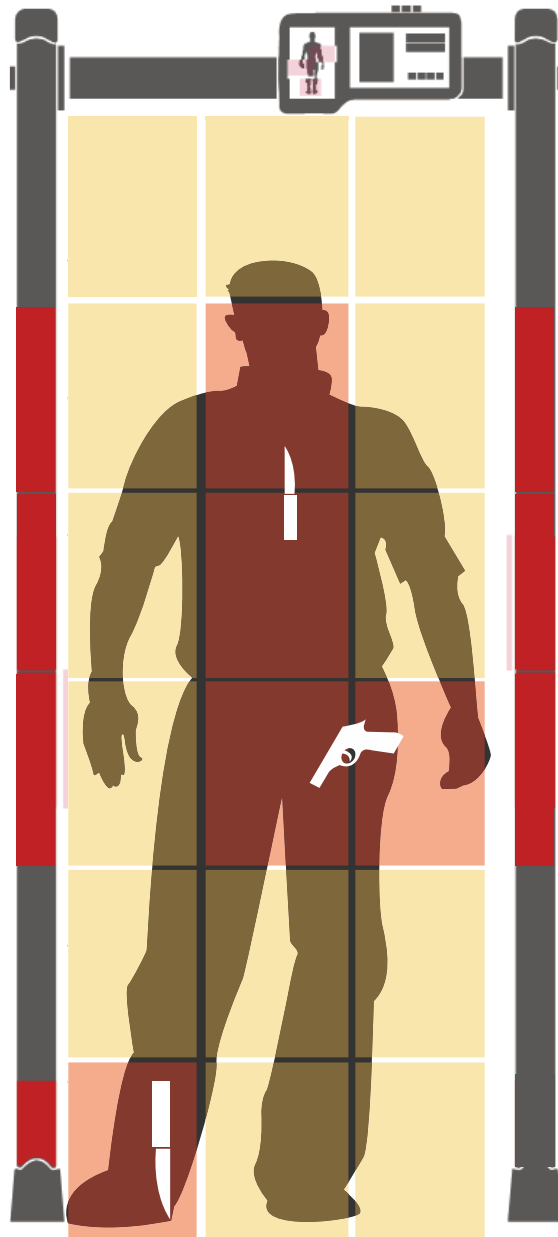

The smaller the histogram, the lower the sensitivity level required.

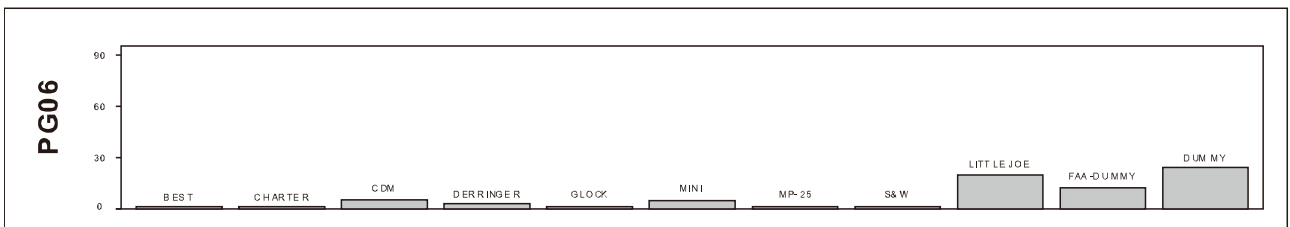
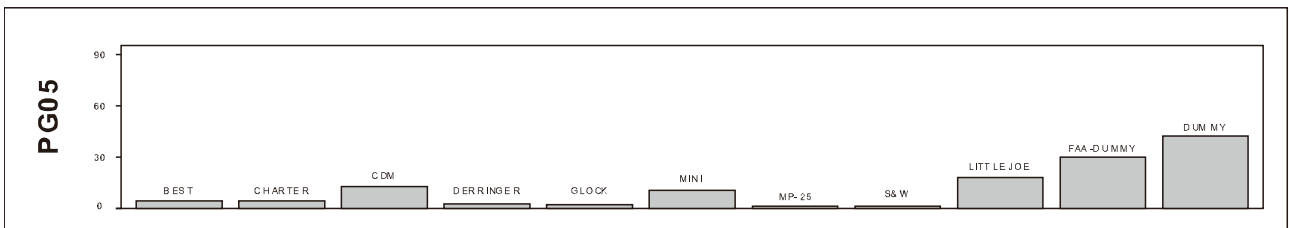
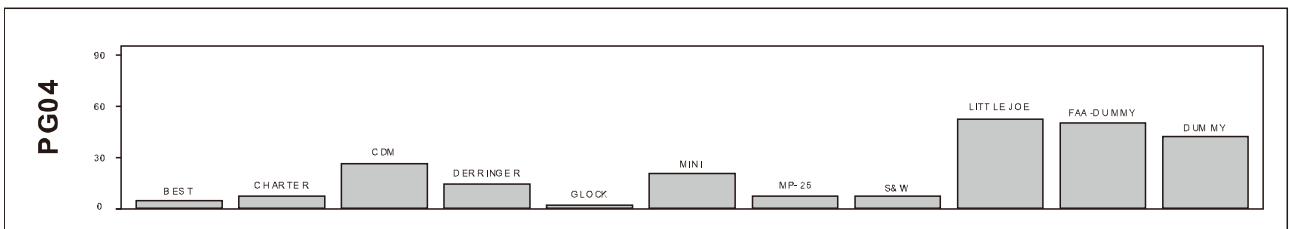
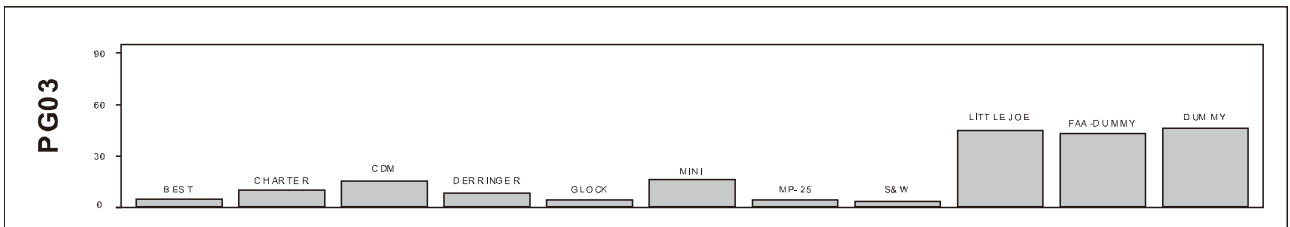
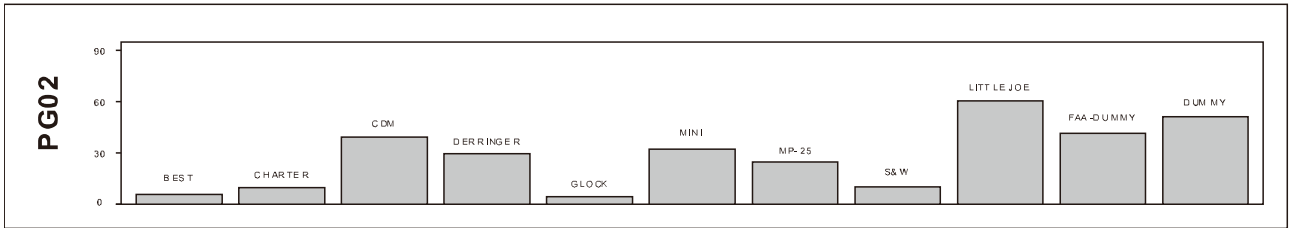
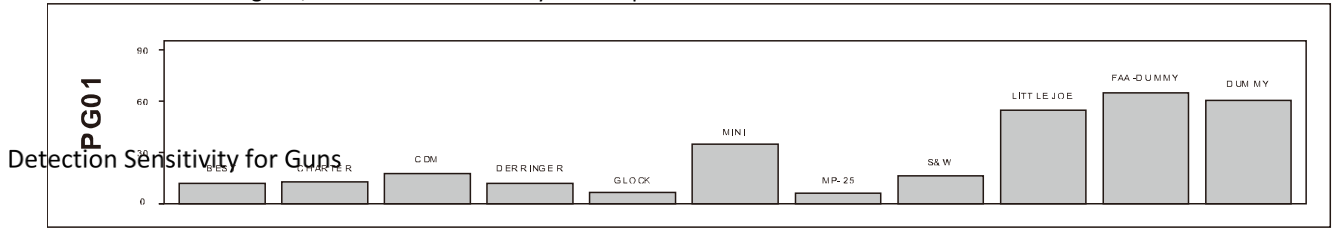

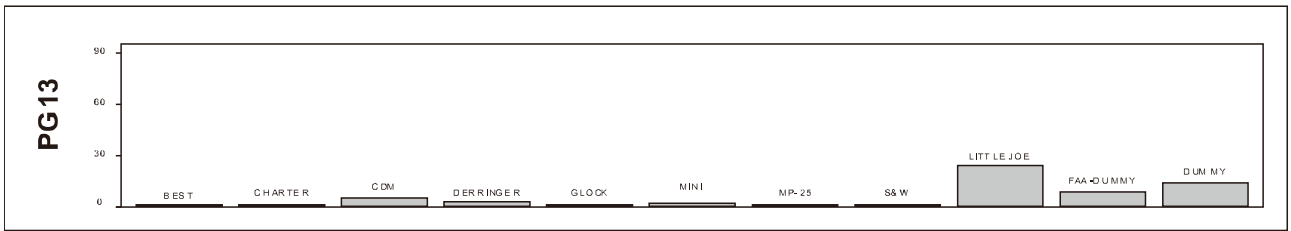
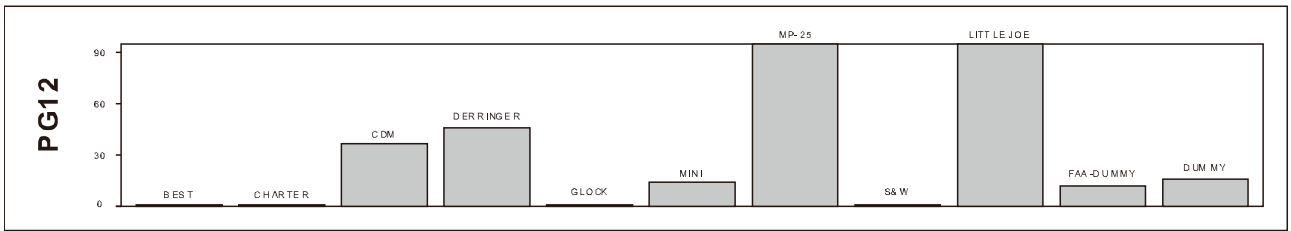
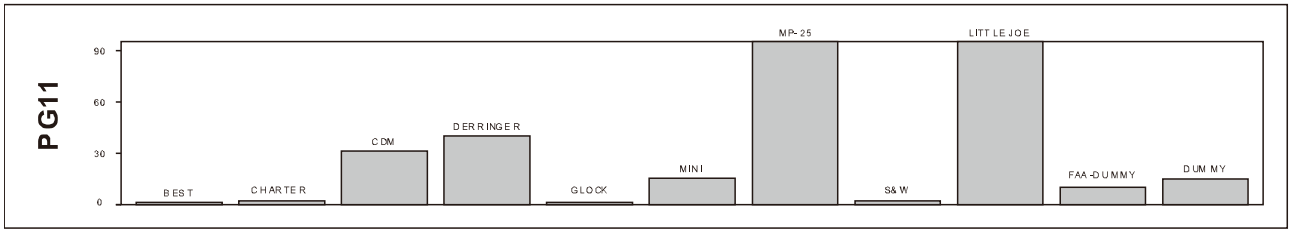
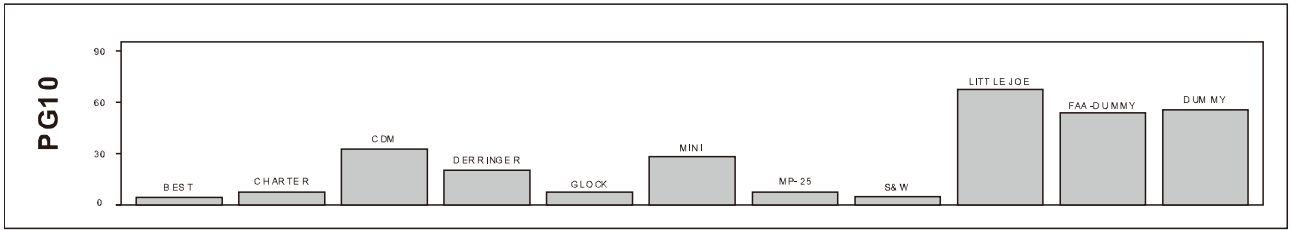
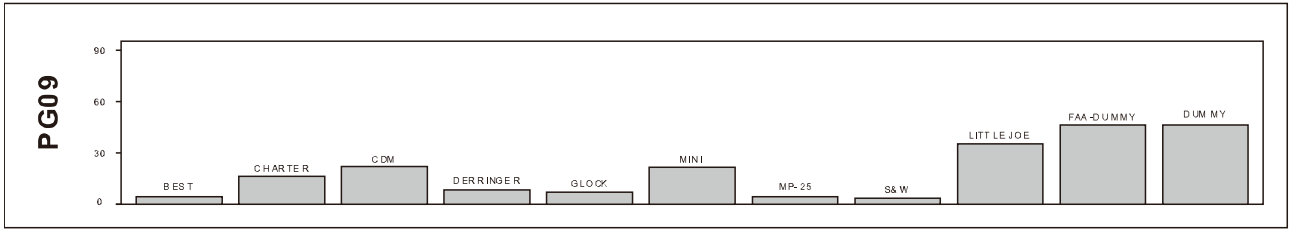
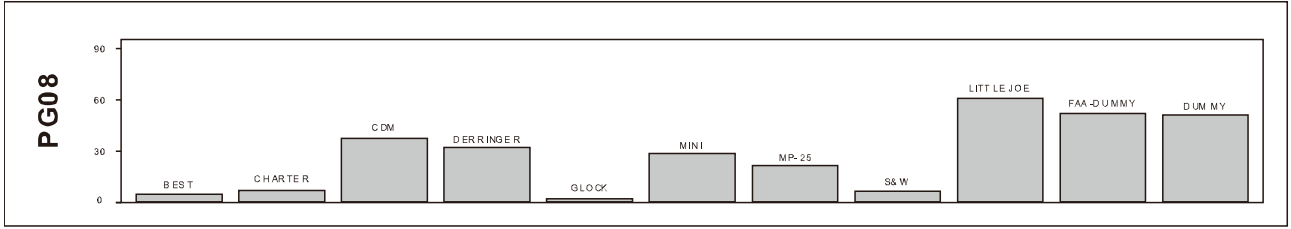
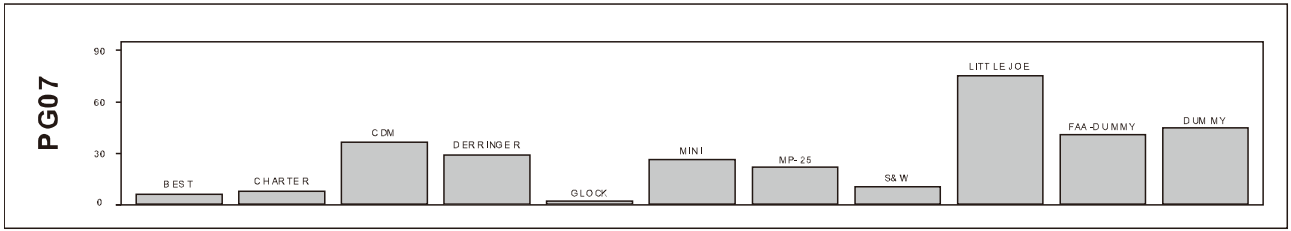

Dimension

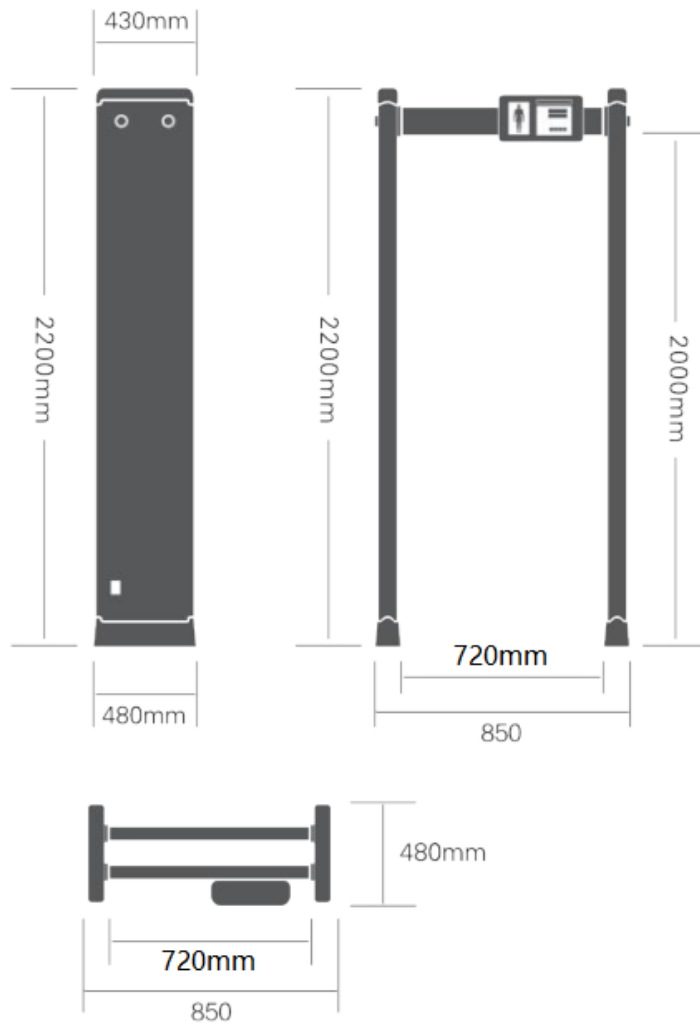

Detection Program	Description	Performance		Distinguishability						
		High Pass	Optimizing Detection	High	Low					
PRG 01 USA PRG 02 USA HD	U.S. airport security requirements	x	x	x	x					
PRG 03 CAN PRG 04 CAN HD	Canadian airport security requirements	x	x	x	x					
PRG 05 GER PRG 06 GER HD	German airport security requirements	x	x	x	x					
PRG 07 UK PRG 08 UK HD	The UK airport security requirements	x	x	x	x					
PRG 09 USG PRG 10 USG HD	U.S. government security requirements	x	x	x	x					
PRG 11 SCA PRG 12 SCA HD	Scandinavian airport security requirements	x	x	x	x					
Material Sensitivity Program										
PRG 13 STANDARD	General detection program									
PRG 21 PB-LEAD	Sensitivity to lead (as opposed to iron)									
PRG 22 MU-METAL	Maximum sensitivity for mu-metal									
PRG 23 ALLMETAL	High sensitivity to all metals									
PRG 24 FE >>>> AL	The procedures from 24 to 32 are compared with 40 mm iron and aluminum tubes.									
PRG 25 FE >>> AL										
PRG 26 FE >> AL										
PRG 27 FE > AL										
PRG 28 FE = AL										
PRG 29 FE < AL										
PRG 30 FE << AL										
PRG 31 FE <<< AL										
PRG 32 FE <<<< AL						Sensitivity: Iron < aluminum				

Specification Thermal Imaging	Sensor	Vanadium oxide uncooled sensor
	Max. Resolution	160× 120
	Pixel Interval	17 μ m
	Response Waveband	8 to 14μm
	NETD	≤ 40mk(@25°C,F#=1.0)
	Lens (Focal Length)	3mm
	MRAD	9.44
	Field of View	50° × 37.2°
	Min. Focusing Distance	0.5m
	Aperture	1.1
	Pseudo Color	15, white heat, black heat, fusion1, rainbow, fusion2, iron oxide red1, iron oxide red2, puce, color1, color2, ice & fire, rain, red heat, green heat, and dark blue
Visible Light	Sensor	4 MP 1/2.7" Progressive Scan CMOS
	Resolution	2688× 1520@25fps
	Min. illuminance	0.0018Lux @(F1.6,AGC ON) ,0 Lux with IR
	Shutter speed	1/3s to 1/100,000s
	Focal length	4mm
	Field angle	84.0° × 44.8°
	Day/Night switch	ICR
	WDR range	120dB
	IR distance	Max. 15 m
Image frame	Thermal imaging and visible light	Thermal imaging integrated with visible light frame
	Picture in picture	Supports visible light and thermal imaging frame over lay
	Smart information overlay	Supports (only temperature measurement rule and temperature are supported)
Smart function	Linkage alarm	Linkage of strobe light and audible alarm
Temperature measurement	Temperature exception detection	Expert mode: 10 pints, 10 frame, 21 rules on each line
	Skin-surface temperature detection	AI detection, multi-target detection
	Measurement range	30 to 45°C
	Temperature Alarm	Alarm triggered when the temperature is over the threshold
	Measurement accuracy	No black body: ±0.5°C (Optional)With black body: ±0.3°C
Compression	Video compression	H.265/H.264/MJPEG
	H265:	Main Profile
	H264:	Baseline Profile / Main Profile / High Profile
	Video bit rate	32 Kbps to 8Mbps
	Video standard	G.711/G.722.1/G.726/MP2L2/PCM
	Audio bit rate	64Kbps(G.711) / 16Kbps(G.722.1) / 16Kbps(G.726) / 32-192Kbps(MP2L2)
Storage	SD card storage	Micro SD/Micro SDHC/Micro SDXC card (128GB or 256GB)

	NVR storage	(96/86/77/76) I series NVR Supports live view/playback, rule display, alarm report, and remote configuration
Network	Main stream	Visible light: 50Hz: 25fps (1920 × 1080), 25fps (1280 × 960), 25fps (1280 × 720) Visible light: 60Hz: 30fps (1920 × 1080), 30fps (1280 × 960), 30fps (1280 × 720) Thermal Imaging: 25fps (160 × 120 (output 320 × 240))
	Sub stream	Visible light: 50Hz: 25fps (704 × 576), 25fps (640 × 480) Visible light: 60Hz: 30fps (704 × 480), 30fps (640 × 480) Thermal Imaging: 25fps (160 × 120 (output 320 × 240))
	Network protocol	IPv4/IPv6,HTTP,HTTPS,802.1x,Qos,FTP,SMTP,UPnP,SNMP,DNS,DNS,NTP,RTSP,RTCP,RTP,TCP,UDP,IGMP,ICMP,DHCP,PPPoE,Bonjour
	Interface protocol	ONVIF(PROFILE S,PROFILE G),ISAPI,SDK,Ehome,GB28181
	Max. live view channel number	20
	User	Three level: administrator, operator, general user
	Safety strategy	User and password authentication, HTTPS encryption, IEEE 802.1x control, IP address filtering
Interface	Alarm input	1, 0 to 5 V alarm input
	Alarm output	1, NO relay output, alarm type configurable
	Audio input	1, 3.5mm Mic in/Line in interface. Line input: 2-2.4V[p-p]
	Audio output	1, 600Ω
	Reset button	1
	Network interface	1,RJ45 10/100M self-adaption
	RS-485 interface	1
	SD card slot	1
	Client	iVMS-4200/HIK-CONNCECT
	Browser	IE7+, Chrome18+, Firefox5.0+, Safari5.02+
General	Power supply	12 VDC
	Consumption	12 V, 3.15A, 36W
	Operation temperature and humidity	Speed dome: 5℃ to 40℃, <95% RH Walk-through detector: -10℃ to 55℃, 99%, RH
	Protective level	Dome camera: IP66 Walk-through detector: IP53
Dimension	Detector dimension(without dome camera)	2200 x 850 x 480mm (H x W x D)
	Dome camera dimension	138.3 mm × 138.3 mm × 123.1 mm(H x W x D)
	Package dimension	2270 x 700 x 230mm(H x W x D)
Weight	Net weight	About 50Kg