



# TURBO HD

# TVI Bullet Camera

## User Manual

**UD04876B**

### **User Manual**

Thank you for purchasing our product. If there are any questions, or requests, do not hesitate to contact the dealer.

This manual applies to the model listed below.

Type	Model
Type I	DS-2CE16D0T-WL3
Type II	DS-2CE16D0T-WL5

This manual may contain several technically incorrect places or printing errors, and the content is subject to change without notice. The updates will be added to the new version of this manual. We will readily improve or update the products or procedures described in the manual.

0100001070302

## Regulatory Information

### FCC Information

**FCC compliance:** This equipment has been tested and found to comply with the limits for a Class A digital device, pursuant to part 15 of the FCC Rules. These limits are designed to provide reasonable protection against harmful interference when the equipment is operated in a commercial environment. This equipment generates, uses, and can radiate radio frequency energy and, if not installed and used in accordance with the instruction manual, may cause harmful interference to radio communications. Operation of this equipment in a residential area is likely to cause harmful interference in which case the user will be required to correct the interference at his own expense.

### FCC Conditions

This device complies with part 15 of the FCC Rules. Operation is subject to the following two conditions:

1. This device may not cause harmful interference.
2. This device must accept any interference received, including interference that may cause undesired operation

### EU Conformity Statement



This product and - if applicable - the supplied accessories too are marked with "CE" and comply therefore with the applicable harmonized European standards

listed under the EMC Directive 2014/30/EU, the RoHS Directive 2011/65/EU.



2012/19/EU (WEEE directive): Products marked with this symbol cannot be disposed of as unsorted municipal waste in the European Union. For proper recycling, return this product to your local supplier upon the purchase of equivalent new

equipment, or dispose of it at designated collection points. For more information see: [www.recyclethis.info](http://www.recyclethis.info).

### Industry Canada ICES-003 Compliance

This device meets the CAN ICES-3 (A)/NMB-3(A) standards requirements.

## Safety Instruction

These instructions are intended to ensure that user can use the product correctly to avoid danger or property loss.

The precaution measure is divided into “Warnings” and “Cautions”

**Warnings:** Serious injury or death may occur if any of the warnings are neglected.

**Cautions:** Injury or equipment damage may occur if any of the cautions are neglected.

	
<b>Warnings</b> Follow these safeguards to prevent serious injury or death.	<b>Cautions</b> Follow these precautions to prevent potential injury or material damage.



### Warnings

- In the use of the device, you must be in strict compliance with the electrical safety regulations of the nation and region.
- Input voltage should meet both the SELV (Safety Extra Low Voltage) and the Limited Power Source with 12 VDC according to the IEC60950-1 standard. Refer to technical specifications for detailed information.
- Do not connect multiple devices to one power adapter to avoid over-heating or a fire hazard caused by overload.
- Make sure that the plug is firmly connected to the power socket.
- Make sure that the device is firmly fixed if wall mounting or ceiling mounting is adopted.
- If smoke, odor or noise rise from the device, turn off the power at once and unplug the power cord, and then contact the service center.
- Never attempt to disassemble the camera by unprofessional personal.



### Cautions

- Do not drop the camera or subject it to physical shock.
- Do not touch sensor modules with fingers.
- If cleaning is necessary, use clean cloth with a bit of ethanol and wipe it gently.
- Do not aim the camera at the sun or extra bright places.
- The sensor may be burned out by a laser beam, so when any laser equipment is in using, make sure that the surface of sensor will not be exposed to the laser beam.
- Do not expose the device to high electromagnetic radiation or extremely hot, cold, dusty or damp environment.
- To avoid heat accumulation, good ventilation is required for the operating environment.
- Keep the camera away from liquid while in use for non-water-proof device.

- While in delivery, the camera shall be packed in its original packing, or packing of the same texture.

# Chapter 1 Introduction

---

## 1.1 Product Features

The camera is applicable for outdoor conditions, and the application scenarios include road, parking lot, campus, etc..

The main features are as follows:

- High performance CMOS sensor
- 1080p resolution
- Auto white balance
- Auto electronic shutter
- Auto gain control (AGC)
- White supplement light
- Up the Coax (HIKVISION-C)

## 1.2 Overview

### 1.2.1 Type I Camera Overview

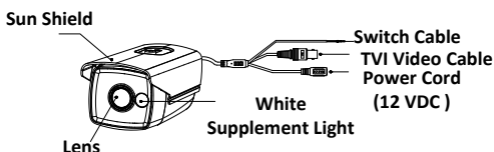

Figure 1. 1 Type I Camera Overview

### 1.2.2 Type II Camera Overview

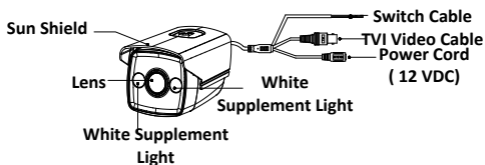

Figure 1. 2 Type II Camera Overview

# Chapter 2 Installation

---

## 2.1 Installation Preparation

### *Before you start:*

- Make sure that the device in the package is in good condition and all the assembly parts are included.
- Make sure that all the related equipment is power-off during the installation.
- Check the specification of the products for the installation environment.
- Check whether the power supply is matched with your power output to avoid damage.
- Make sure the wall is strong enough to withstand three times the weight of the camera and the bracket.
- If the wall is cement, insert expansion bolts before you install the camera. If the wall is wooden, use self-tapping screws to secure the camera.
- If the product does not function properly, contact your dealer or the nearest service center. Do NOT

disassemble the camera for repair or maintenance by yourself.

**Note:**

Since type I camera and type II camera share the same installation method, we take type I camera as the example to describe the installation.

## 2.2 Wall Mounting

**Before you start:**

The package contains the wall mounting bracket.

**Steps:**

1. Attach the bracket to the wall.
2. Mark the screw holes on the wall according to the holes on the bracket.
3. Drill the screw holes.
4. Attach the bracket to the wall and secure the camera with supplied screws.

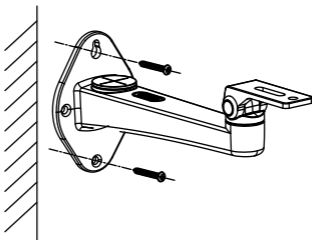

Figure 2. 1 Secure the camera to the wall

**Note:**

- In the supplied screw package, both self-tapping screws and expansion bolts are contained.
  - If the wall is cement, expansion bolts are required to fix the camera. If the wall is wooden, self-tapping screws are required.
5. Align the camera to the pedestal, and secure the camera on the pedestal with supplied screws.

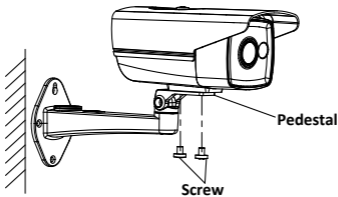

Figure 2. 2 Secure the Camera on the Bracket

6. Route the cables and connect the corresponding power cord and video cable.
7. Power on the camera to check whether the image on the monitor is gotten from the optimum angle. If not, adjust the camera according to the figure below to get an optimum angle.
  - 1). Loosen the horizontal adjusting screw to adjust the pan position ( $0^{\circ}$  to  $360^{\circ}$ ).
  - 2). Tighten the horizontal adjusting screw.
  - 3). Loosen the vertical adjusting screw to adjust the tilt position ( $0^{\circ}$  to  $90^{\circ}$ )
  - 4). Tighten the vertical adjusting screw.

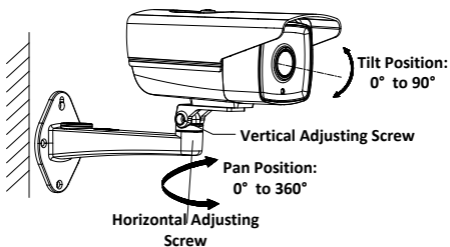

Figure 2. 3 Angle Adjustment

## 2.3 Pendant Mounting

### **Before you start:**

You need to purchase a pendant bracket first.

### **Steps:**

1. Attach the bracket to the ceiling.
2. Mark the screw holes on the ceiling according to the holes on the bracket.
3. Drill the screw holes.
4. Attach the bracket to the ceiling and secure the camera with supplied screws.

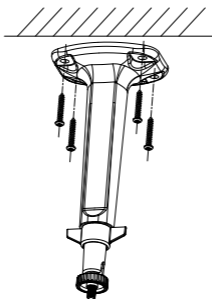

Figure 2. 4 Fix the Bracket on the Ceiling

### **Note:**

- In the supplied screw package, both self-tapping screws and expansion bolts are contained.
  - If the wall is cement, expansion bolts are required to fix the camera. If the wall is wooden, self-tapping screws are required.
5. Remove the screw on the top of the camera to expose the screw hole.

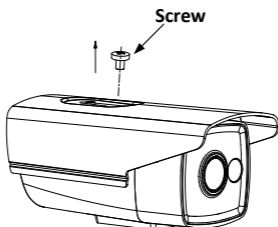

Figure 2. 5 Remove the Screw

6. Align the screw hole on the top of the camera with the pendant mounting bracket and rotate the camera to get it fixed.

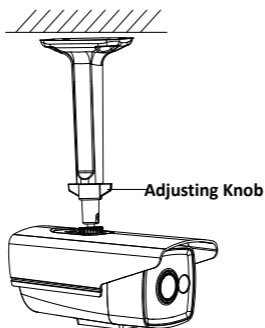

Figure 2. 6 Fix the Camera to the Bracket

7. Route the cables and connect the corresponding power cord and video cable.
8. Power on the camera to check whether the image on the monitor is gotten from the optimum angle. If not, adjust the camera according to the figure below to get an optimum angle.
  - 1). Loosen the adjusting knob to adjust the pan position ( $0^{\circ}$  to  $360^{\circ}$ ) and tilt position ( $0^{\circ}$  to  $90^{\circ}$ )
  - 2). Tighten the adjusting knob.

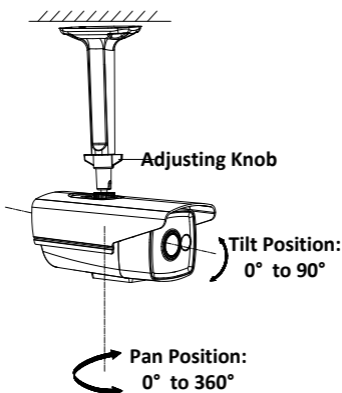

Figure 2. 7 Angle Adjustment