

HIKVISION

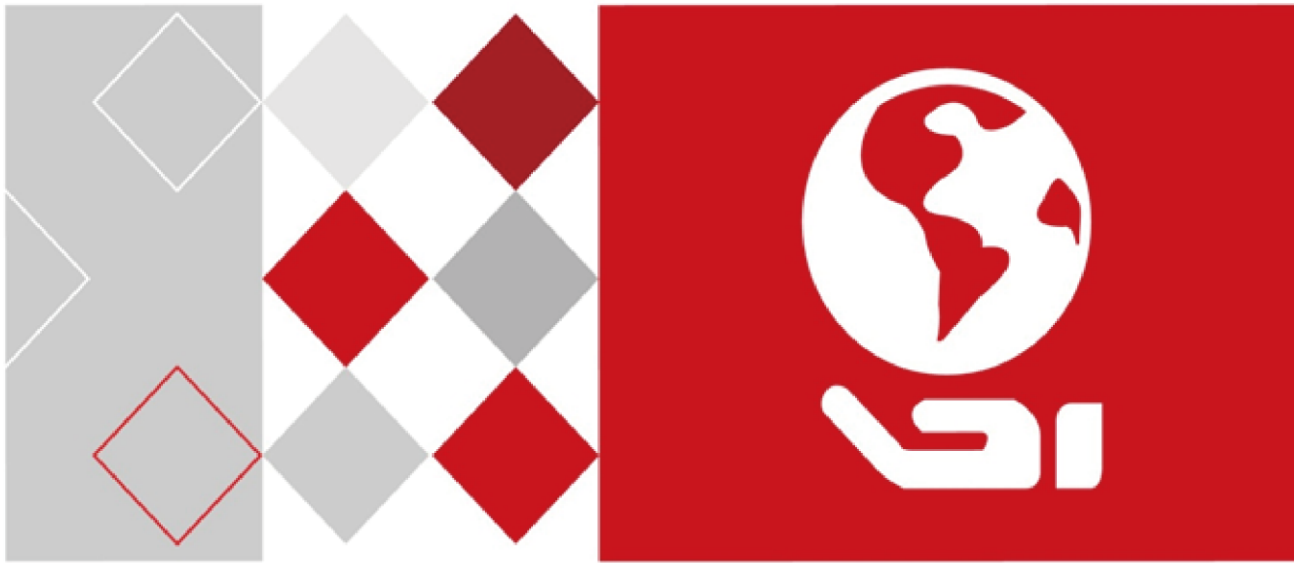

Mobile Digital Video Recorder

User Manual

UD02710B

User Manual

COPYRIGHT ©2015 Hangzhou Hikvision Digital Technology Co., Ltd.

ALL RIGHTS RESERVED.

Any and all information, including, among others, wordings, pictures, graphs are the properties of Hangzhou Hikvision Digital Technology Co., Ltd. or its subsidiaries (hereinafter referred to be “Hikvision”). This user manual (hereinafter referred to be “the Manual”) cannot be reproduced, changed, translated, or distributed, partially or wholly, by any means, without the prior written permission of Hikvision. Unless otherwise stipulated, Hikvision does not make any warranties, guarantees or representations, express or implied, regarding to the Manual.

About this Manual

This Manual is applicable to Mobile Digital Video Recorder.

The Manual includes instructions for using and managing the product. Pictures, charts, images and all other information hereinafter are for description and explanation only. The information contained in the Manual is subject to change, without notice, due to firmware updates or other reasons. Please find the latest version in the company website (<http://overseas.hikvision.com/en/>).

Please use this user manual under the guidance of professionals.

Trademarks Acknowledgement

HIKVISION and other Hikvision’s trademarks and logos are the properties of Hikvision in various jurisdictions. Other trademarks and logos mentioned below are the properties of their respective owners.

Legal Disclaimer

TO THE MAXIMUM EXTENT PERMITTED BY APPLICABLE LAW, THE PRODUCT DESCRIBED, WITH ITS HARDWARE, SOFTWARE AND FIRMWARE, IS PROVIDED “AS IS”, WITH ALL FAULTS AND ERRORS, AND HIKVISION MAKES NO WARRANTIES, EXPRESS OR IMPLIED, INCLUDING WITHOUT LIMITATION, MERCHANTABILITY, SATISFACTORY QUALITY, FITNESS FOR A PARTICULAR PURPOSE, AND NON-INFRINGEMENT OF THIRD PARTY. IN NO EVENT WILL HIKVISION, ITS DIRECTORS, OFFICERS, EMPLOYEES, OR AGENTS BE LIABLE TO YOU FOR ANY SPECIAL, CONSEQUENTIAL, INCIDENTAL, OR INDIRECT DAMAGES, INCLUDING, AMONG OTHERS, DAMAGES FOR LOSS OF BUSINESS PROFITS, BUSINESS INTERRUPTION, OR LOSS OF DATA OR DOCUMENTATION, IN CONNECTION WITH THE USE OF THIS PRODUCT, EVEN IF HIKVISION HAS BEEN ADVISED OF THE POSSIBILITY OF SUCH DAMAGES.

REGARDING TO THE PRODUCT WITH INTERNET ACCESS, THE USE OF PRODUCT SHALL BE WHOLLY AT YOUR OWN RISKS. HIKVISION SHALL NOT TAKE ANY RESPONSIBILITIES FOR ABNORMAL OPERATION, PRIVACY LEAKAGE OR OTHER DAMAGES RESULTING FROM CYBER ATTACK, HACKER ATTACK, VIRUS INSPECTION, OR OTHER INTERNET SECURITY RISKS; HOWEVER, HIKVISION WILL PROVIDE TIMELY TECHNICAL SUPPORT IF REQUIRED.

SURVEILLANCE LAWS VARY BY JURISDICTION. PLEASE CHECK ALL RELEVANT LAWS IN YOUR JURISDICTION BEFORE USING THIS PRODUCT IN ORDER TO ENSURE THAT YOUR USE CONFORMS THE APPLICABLE LAW. HIKVISION SHALL NOT BE LIABLE IN THE EVENT THAT THIS PRODUCT IS USED WITH ILLEGITIMATE PURPOSES.

IN THE EVENT OF ANY CONFLICTS BETWEEN THIS MANUAL AND THE APPLICABLE LAW, THE LATER PREVAILS.

Regulatory Information

FCC Information

Please take attention that changes or modification not expressly approved by the party responsible for compliance could void the user's authority to operate the equipment.

FCC compliance: This equipment has been tested and found to comply with the limits for a Class B digital device, pursuant to part 15 of the FCC Rules. These limits are designed to provide reasonable protection against harmful interference in a residential installation. This equipment generates, uses and can radiate radio frequency energy and, if not installed and used in accordance with the instructions, may cause harmful interference to radio communications. However, there is no guarantee that interference will not occur in a particular installation. If this equipment does cause harmful interference to radio or television reception, which can be determined by turning the equipment off and on, the user is encouraged to try to correct the interference by one or more of the following measures:

- Reorient or relocate the receiving antenna.
- Increase the separation between the equipment and receiver.
- Connect the equipment into an outlet on a circuit different from that to which the receiver is connected.
- Consult the dealer or an experienced radio/TV technician for help.

This equipment should be installed and operated with a minimum distance 20cm between the radiator and your body.

FCC Conditions

This device complies with part 15 of the FCC Rules. Operation is subject to the following two conditions:

1. This device may not cause harmful interference.
2. This device must accept any interference received, including interference that may cause undesired operation.

EU Conformity Statement



This product and - if applicable - the supplied accessories too are marked with "CE" and comply therefore with the applicable harmonized European standards listed under the RE Directive 2014/53/EU, the EMC Directive 2014/30/EU, the RoHS Directive 2011/65/EU.



2012/19/EU (WEEE directive): Products marked with this symbol cannot be disposed of as unsorted municipal waste in the European Union. For proper recycling, return this product to your local supplier upon the purchase of equivalent new equipment, or dispose of it at designated collection points. For more information see:

www.recyclethis.info



2006/66/EC (battery directive): This product contains a battery that cannot be disposed of as unsorted municipal waste in the European Union. See the product documentation for specific battery information. The battery is marked with this symbol, which may include lettering to indicate cadmium (Cd), lead (Pb), or mercury (Hg).

For proper recycling, return the battery to your supplier or to a designated collection point. For more information see:

www.recyclethis.info

Industry Canada ICES-003 Compliance

This device meets the CAN ICES-3 (B)/NMB-3(B) standards requirements.

This device complies with Industry Canada licence-exempt RSS standard(s). Operation is subject to the following two conditions:

- (1) this device may not cause interference, and

(2) this device must accept any interference, including interference that may cause undesired operation of the device.

Le présent appareil est conforme aux CNR d'Industrie Canada applicables aux appareils radioexempts de licence. L'exploitation est autorisée aux deux conditions suivantes :

(1) l'appareil ne doit pas produire de brouillage, et

(2) l'utilisateur de l'appareil doit accepter tout brouillage radioélectrique subi, même si le brouillage est susceptible d'en compromettre le fonctionnement.

Under Industry Canada regulations, this radio transmitter may only operate using an antenna of a type and maximum (or lesser) gain approved for the transmitter by Industry Canada. To reduce potential radio interference to other users, the antenna type and its gain should be so chosen that the equivalent isotropically radiated power (e.i.r.p.) is not more than that necessary for successful communication.

Conformément à la réglementation d'Industrie Canada, le présent émetteur radio peut fonctionner avec une antenne d'un type et d'un gain maximal (ou inférieur) approuvé pour l'émetteur par Industrie Canada. Dans le but de réduire les risques de brouillage radioélectrique à l'intention des autres utilisateurs, il faut choisir le type d'antenne et son gain de sorte que la puissance isotrope rayonnée équivalente (p.i.r.e.) ne dépasse pas l'intensité nécessaire à l'établissement d'une communication satisfaisante.

This equipment should be installed and operated with a minimum distance 20cm between the radiator and your body.

Cet équipement doit être installé et utilisé à une distance minimale de 20 cm entre le radiateur et votre corps.



Safety Instruction

These instructions are intended to ensure that user can use the product correctly to avoid danger or property loss.

The precaution measure is divided into “Warnings” and “Cautions”

Warnings: Serious injury or death may occur if any of the warnings are neglected.

Cautions: Injury or equipment damage may occur if any of the cautions are neglected.

	
Warnings Follow these safeguards to prevent serious injury or death.	Cautions Follow these precautions to prevent potential injury or material damage.



Warnings

- Proper configuration of all passwords and other security settings is the responsibility of the installer and/or end-user.
- In the use of the product, you must be in strict compliance with the electrical safety regulations of the nation and region. Please refer to technical specifications for detailed information.
- Input voltage should meet both the SELV (Safety Extra Low Voltage) and the Limited Power Source with +9 to +32 VDC according to the IEC60950-1 standard. Please refer to technical specifications for detailed information.
- Do not connect several devices to one power adapter as adapter overload may cause over-heating or a fire hazard.
- Please make sure that the plug is firmly connected to the power socket.
- If smoke, odor or noise rise from the device, turn off the power at once and unplug the power cable, and then please contact the service center.

Thank you for purchasing our product. If there is any question or request, please do not hesitate to contact the dealer.

This manual is applicable to the following models.

Series	Models
DS-MP7508 Series	DS-MP7508
	DS-MP7508/GW
	DS-MP7508/GW/WI
	DS-MP7508/GLF/WI

This manual may contain several technically incorrect places or printing errors, and the content is subject to change without notice. The updates will be added into the new version of this manual.

We will readily improve or update the products or procedures described in the manual.

The figures shown in this manual are for reference only. The appearance and interface of the device are subject to the actual model.

Safety Instructions

- Read, keep and follow these instructions.
- Professional automobile assembly manufacturers or automakers are required for the system installation. And place the device at a well-ventilated position inside the automobile.
- Please make yourself be familiar with the power connection before installation.
- Install antennas of wireless networks and satellite positioning in place with good signal and away from lightning, avoiding the coverage or shielding of other objects. Keep the master and slave antennas upright in a distance of at least 20cm if both of them are installed.
- The system is made of sophisticated electronics and do not disassemble the device by yourself.
- Contact the qualified technician from manufacturer or authorized dealer if there is any question or request.

Product Key Features

General

- User-friendly GUI providing easy and flexible operations.
- Each channel supports up to 1080p resolution with high-efficient and flexible H.264 encoding technology.
- Two HDDs/SSDs are connectable.
- Hard disk box with fan and USB interface supporting intelligent temperature control and data export.
- Power-off protection avoiding key data from loss.
- Backup recording on HDD/SSD ensures the completeness of video files; Event triggered recording can be stored on the HDD/SSD a simultaneously to protect the key data.
- Built-in GNSS (Global Navigation Satellite System) module precisely positioning the vehicle via the satellite and recording the location information in the stream.
- Information collection interfaces collecting driving information such as left/right turn, braking, backing up, etc.
- Multiple extension interfaces supporting display terminal of alarm and status, external G-sensor, etc.
- Specialized aviation connectors ensuring signal stability.
- Ignition startup, Delay (0 to 6h) shutdown and 24-hour scheduled startup/shutdown.
- Wide-range power input (+9 to +32 VDC).
- Tensile aluminum chassis well adaptable to working environment.
- Software-based firewall supported.

Local Monitoring

- 1/4/9-division live view and adjustable display sequence of screens.
- Shielding designated live view channel.
- Motion detection, tamper-proof, video exception alarm and video loss alarm.
- Privacy mask.
- Up to 8 TVI cameras can be connected.

Hard Disk Management

- Supports two HDDs/SSDs with 1T capacity for each.

Record and Playback

- Cycle recording and non-cycle recording supported.
- Three types of compression parameters including main stream (normal), main stream (event) and sub-stream.
- Multiple recording types: normal, alarm, motion, motion | alarm, motion & alarm.
- Up to 8 time periods configurable for different recording types.
- Pre-record and post-record for motion or alarm triggered recording.
- Search and play back record files by camera No., recording type, start/end time, etc.
- Supporting pause, fast forward, slow forward, skip forward, skip backward and mute when playback.

Backup

- Export video data by USB device.
- Export video data by pluggable hard disk.
- Management and maintenance of backup devices.

Alarm and Exception

- Management of alarm input/output.
- Management of video loss alarm, motion detection alarm, video tampering alarm.
- Configurable arming schedule of alarm input/output.
- Alarm for video loss, motion detection, video tampering, video signal exception, video input/output standard mismatch, illegal login, network disconnected, IP confliction, hard disk error, and hard disk full.
- Multiple alarm linkage actions including full screen monitoring, audible warning and alarm output. Motion detection and alarm can trigger recording and full screen monitoring. Exception can trigger audible warning and alarm output.
- Automatic restore when system is abnormal.
- Supporting alarm and status display terminal.

Other Local Functions

- Two-level user management; admin user is allowed to configure the parameters and create many operators.
- Supporting record and search the logs of operation, alarm, exceptions and information.
- Upgrade system via USB, network or RS-232 interface.
- Import/export of device configuration file.

Network Functions

- One RJ45 10M/100M/1000M self-adaptive Ethernet interface.
- Built-in 3G/4G (WCDMA) and WI-FI modules providing flexible data transmission solutions.
- Remote configuration and operation by iVMS platform.
- TCP/IP, DHCP, DNS, NTP, and SADP supported.
- Remote search, playback, download of record files.
- Remote parameters setup; remote import/export of device parameters.
- Remote viewing of the device status, system logs and alarm status.
- Remote hard disk formatting, program upgrading and system restart.
- RS-232, RS-485 transparent channel transmission.

Development Scalability

- SDK for Windows and Linux system.
- Development support and training for application system.



- The Wi-Fi function is only supported by the “/WI” devices.
- The 3G dialing function is supported by the “/GW” devices.
- The 4G dialing function is only supported by the “/GLF” devices.

TABLE OF CONTENTS

Product Key Features.....	7
Chapter 1 Introduction.....	11
1.1 Front Panel.....	11
1.2 Rear Panel.....	11
1.3 IR Remote Control Introduction	12
1.3.1 Buttons Description.....	12
1.3.2 Operation Introduction	14
1.3.3 Remote Control Troubleshooting	14
1.4 Starting Up and Shutting Down the Device	15
1.4.4 Vehicle Ignition Startup and Time-delay Shutdown	15
1.4.5 Timing On/Off.....	17
1.5 Alarm Input/Output Connection	17
1.5.1 Alarm Input Connection	17
1.5.2 Alarm Output Connection	18
1.6 HDD/SSD Installation	18
1.7 SD Card Installation	20
1.8 SIM Card Installation	21
Chapter 2 Basic Operations.....	23
2.1 Setting Admin Password.....	23
2.2 Main Page.....	23
2.3 User Management.....	24
2.4 Display Settings.....	25
2.5 Camera Settings.....	27
2.6 Preview Settings	29
Chapter 3 Record Settings.....	31
3.1 Configuring Encoding Parameters	31
3.1.1 Formatting Storage Device	31
3.1.2 Configuring Record Settings	31
3.2 Configuring Motion Detection Record	33
3.3 Configuring Alarm Triggered Record	35
Chapter 4 Playback.....	36
4.1 Playing Back General Video.....	36
4.1.1 Playback by Camera and Time	36
4.1.2 Playback by Video.....	37
4.2 Playing Back Event Video	38
Chapter 5 Video Backup.....	39
Chapter 6 PTZ Controls	40
6.1 Configuring PTZ Settings.....	40

6.2	PTZ Control Panel	40
Chapter 7	Wireless Network Settings	42
7.1	Dialing Settings	42
7.2	Wi-Fi Settings	43
Chapter 8	Storage.....	46
Chapter 9	Platform Settings.....	47
Chapter 10	Mobile Specified Functions.....	48
10.1	Configuring Startup and Shutdown.....	48
10.2	Configuring Satellite Positioning.....	49
10.3	Configuring G-Sensor Alarm.....	50
10.4	Configuring Sensor-in.....	50
Chapter 11	Other Functions.....	52
11.1	Local Network Settings	52
11.2	Alarm Settings	53
11.2.1	Configuring Alarm Input	53
11.2.2	Configuring Alarm Output	54
11.2.3	Configuring Video-Tampering Alarm.....	55
11.2.4	Configuring Video Loss Alarm.....	57
11.2.5	Handling Exceptions	58
11.2.6	Configuring Alarm Terminal	59
11.3	Firewall Settings	59
11.4	Serial Port Settings	61
Chapter 12	Device Maintenance	62
12.1	Checking Status	62
12.2	Management and Maintenance	62
12.2.1	Upgrading the System	62
12.2.2	Searching & Exporting Log files	64
12.2.3	Restoring Default Settings.....	65
12.2.4	Importing/Exporting Configuration Files	65
12.2.5	Viewing System Information.....	66
12.2.6	Backup Device	66
12.2.7	Rebooting DVR.....	67
Chapter 13	Appendix.....	68
13.1	Glossary	68
13.2	FAQ	69

Chapter 1 Introduction

1.1 Front Panel

The front panel of DS-MP7508 series is displayed below:

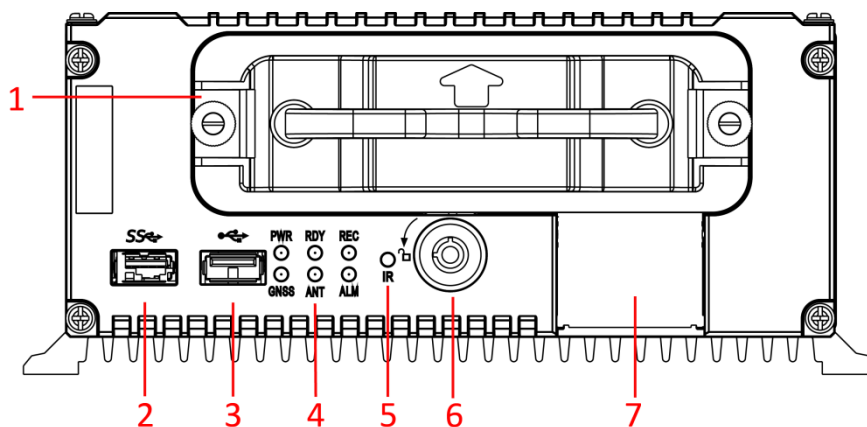

Figure 1. 1 Front Panel

Table 1. 1 Description of Front Panel

No.	Name	Description
1	Hard disk box	Insert two 2.5-inch SATA HDDs/SSDs for data storage.
2	USB	A-type USB 3.0 interface
3	USB	Standard USB 2.0 interface
4	PWR	Power indicator: Light in green after device starts up; light in red when standby mode.
	RDY	Ready indicator: Lights green after device starts up properly.
	REC	Record indicator: Light in green during recording process.
	GNSS	GNSS indicator: Solid green indicates GNSS module is normal. Flashing green indicates positioning succeeded.
	ANT	ANT indicator: Solid green indicates dialing module is normal. Flashing green indicators device dialed.
	Alarm	Alarm indicator: Lights red when alarm occurs.
5	IR receiver	Receive IR signal from remote control.
6	Hard disk lock	Lock/Unlock the hard disk box.
7	SD card slot	Slot where SD card installed.

1.2 Rear Panel

The rear panel of DS-MP7508 series is displayed below:

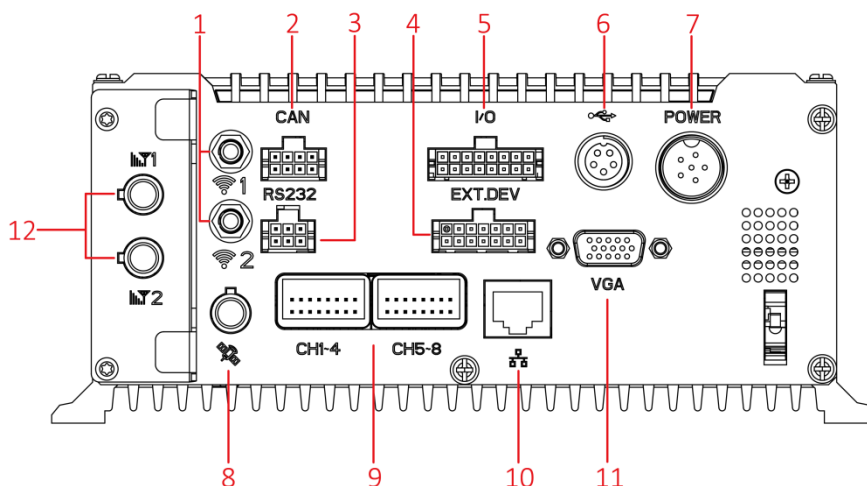

Figure 1. 2 Rear Panel

Table 1. 2 Description of Rear Panel

No.	Name	Description
1	WIFI	WiFi antenna interface
2	CAN	CAN interface
3	RS-232	RS-232 interface
4	EXT.DEV	RS-422 communication interface, two-way audio interface, and CVBS video output.
5	I/O	4-ch alarm inputs, 4-ch sensor in; 1-ch pulse signal input.
6	USB	USB interface of 5-pin aviation plug
7	POWER	6-pin aviation plug for power supply
8	GNSS	GNSS antenna interface
9	CH1 to CH4 and CH5 to 8	8 video & audio inputs.
10	Network interface	1, RJ45 10M/100M/1000M self-adaptive Ethernet interface
11	VGA	VGA video output interface
12	3G/4G	3G/4G dialing antenna interface



- The 3G/4G dialing function is only supported by the “/GW” devices.
- The Wi-Fi function is only supported by the “/WI” devices.

1.3 IR Remote Control Introduction

The mobile DVR can be controlled via IR remote control and mouse.

1.3.1 Buttons Description

Purpose:

The interface of IR remote control is shown in *Figure 1.3*.



Batteries (2×AAA) must be installed before operation.

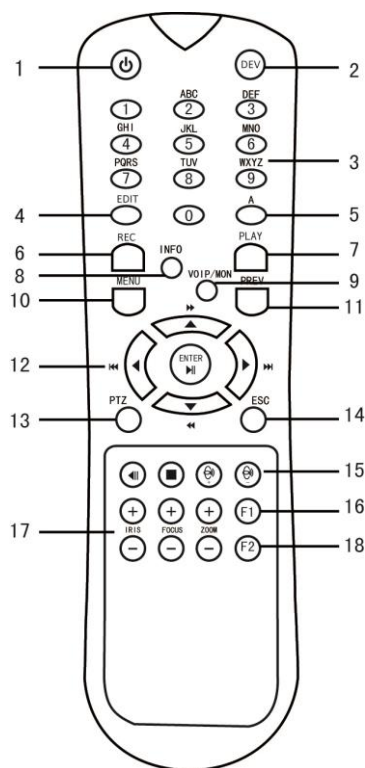

Figure 1.3 Remote Control

Table 1.3 Description of the IR Remote Control Buttons

No.	Name	Description
1	Power	Reserved
2	DEV	Input device number.
3	Number keys	1.Input number, symbol, and character. 2.Switch to the corresponding channel in Live View mode.
4	Edit	1.Enter the edit status, and then delete the character in the front of the cursor. 2.It can also be used to <i>tick</i> checkbox. 3.In Playback mode, it can be used to generate video clips for backup.
5	A	Switch between input methods (Number, English, symbol) when in the edit status.
6	REC	Reserved
7	PLAY	Enter video search interface.
8	INFO	Reserved
9	VOIP/MON	Reserved
10	MENU	Enter Main menu interface.
11	PREV	Switch between single screen and multi-screen mode.

12	DIRECTION Buttons	Up, Down, Left, Right 1.The DIRECTION buttons are used to navigate between different fields and items in menus. 2.In the playback interface, they are used for fast forward, slow forward, rewind. 3.In Live View mode, these buttons can be used to switch channel(s).
	ENTER	1.The ENTER button is used to confirm selection in any of the menu modes. 2.It can also be used to <i>tick</i> checkbox. 3.In Playback mode, it can be used to play or pause the video. 4. In Auto-switch mode, it can be used to stop /start auto switch.
13	PTZ	Reserved
14	ESC	Back to the previous menu.
15	RESERVED	Reserved for future use.
16	F1	In video search interface, it can be used to select all record files.
17	PTZ Control Buttons	Buttons to adjust the iris, focus and zoom of a PTZ camera.
18	F2	Reserved

1.3.2 Operation Introduction

In this chapter we will describe the operation via IR remote control about general steps in the following chapters.

Step	Operation
Enter some contents in a text field.	<ol style="list-style-type: none"> 1. Press the Left/Right button to position the cursor in the text field. 2. Press the Enter button to edit. 3. Press the Edit button to delete the previous content. 4. Press the A button to switch input method. 5. Press the numeric buttons to enter numbers, symbols, or characters. 6. Press the Enter button to finish entering.
Click a button.	<ol style="list-style-type: none"> 1. Press the Left/Right button to position the cursor in the checkbox. 2. Press the Enter button to click the button.
Check the checkbox of a button.	<ol style="list-style-type: none"> 3. Press the Left/Right button to position the cursor in the checkbox. 4. Press the Enter/Edit button to check the checkbox.
Select an item from an option dropdown list.	<ol style="list-style-type: none"> 7. Press the Left/Right button to position the cursor in the option. 8. Press the Enter button to pop up dropdown list. 9. Press the Up/Down button to select an item. 10. Press the Enter button to select it.

1.3.3 Remote Control Troubleshooting



Make sure you have installed batteries properly in the remote control. And you have to aim the remote control at the IR

receiver in the front panel.

If there is no response after you press any button on the remote, follow the procedure below to troubleshoot.

Steps:

1. Enter Menu > Other Settings > Display > Advanced Settings by operating the mouse.
2. Check and remember device ID#. The default ID# is 255. This ID# is valid for all the IR remote controls.
3. Press the DEV key on the remote control.
4. Enter the device ID# in step 2.
5. Press the ENTER button on the remote.

If the Status indicator on the front panel turns blue, the remote control is operating properly. If the Status indicator does not turn blue and there is still no response from the remote, please check the following:



When the device ID# is 255, the Status indicator is off when device is controlled by an IR remote control.

1. Batteries are installed correctly and the polarities of the batteries are not reversed.
2. Batteries are fresh and not out of charge.
3. IR receiver is not obstructed.

If the remote still can't function properly, please change a remote and try again, or contact the device provider.

1.4 Starting Up and Shutting Down the Device

Two working modes are available for the mobile DVR. The connection of power cables and control interfaces varies from the device working mode.

- Vehicle ignition startup and time-delay shutdown

The mobile DVR starts up when the vehicle ignites and shuts down according to the pre-defined delay time after the vehicle is off. The startup and shutdown of the device depend on the vehicle ignition signal.

- Timing on/off

The mobile DVR starts up or shuts down automatically according to the pre-defined time and the device works separately from the running status of the vehicle.

1.4.4 Vehicle Ignition Startup and Time-delay Shutdown

The vehicle ignition startup and time-delay shutdown are realized by the vehicle ignition switch, which includes positive pole ignition switch (providing high level signal when the switch closes) and negative pole ignition switch (providing low level signal when the switch closes). The wire connection of the device varies from different vehicle ignition switch.

For detailed time settings of time-delay shutdown, see *10.1 Configuring Startup and Shutdown*.



- Please contact the vehicle manufacturer for the connection information of starting switch.
- The vehicle ignition switch, also called car key, controls the startup and shutdown of the vehicle. Most of the cars adopts positive pole ignition switch currently.

Positive Pole Ignition Switch

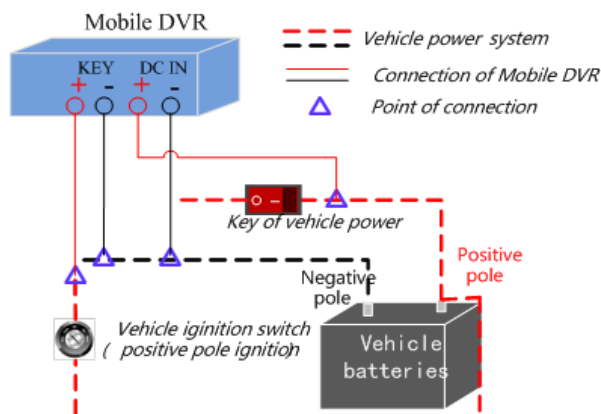

Figure 1. 4 Connection of Positive Pole Ignition Switch

Ignition switch is connected to the positive pole of DC+12/24V of vehicle batteries. Please make sure that the connection is correct, and then perform the following steps:

Steps:

1. Connect the “DC IN +” of mobile DVR to the positive pole of vehicle batteries, jumping over the switch of normal vehicle power.
2. Connect the “DC IN -” and “KEY -” of mobile DVR to the negative pole of vehicle batteries.
3. Connect the “KEY +” of mobile DVR to the vehicle ignition switch.



The normal vehicle power refers to the main power of the vehicle power supply system. After the vehicle is off, the normal vehicle power still provides direct-current source for the other devices inside and generally a main switch is used to turn on/off it.

Negative Pole Ignition Switch

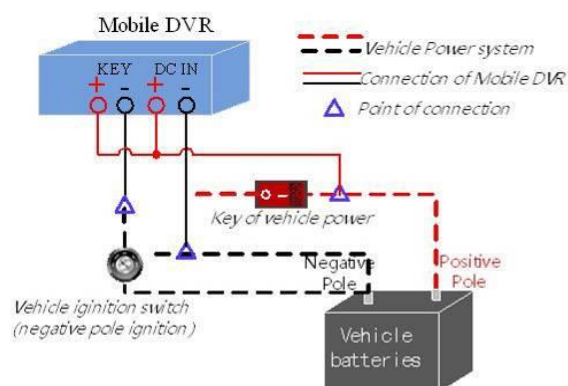

Figure 1. 5 Connection of Negative Pole Ignition Switch

Ignition switch is connected to the negative pole of DC+12/24V of vehicle batteries. Please make sure that the connection is

correct, and then perform the following steps:

Steps:

1. Connect the “DC IN +” and “KEY +” of mobile DVR to the positive pole of vehicle batteries, jumping over the switch of normal vehicle power.
2. Connect the “DC IN -” to the negative pole of vehicle batteries.
3. Connect the “KEY -” of mobile DVR to the vehicle ignition switch.

1.4.5 Timing On/Off

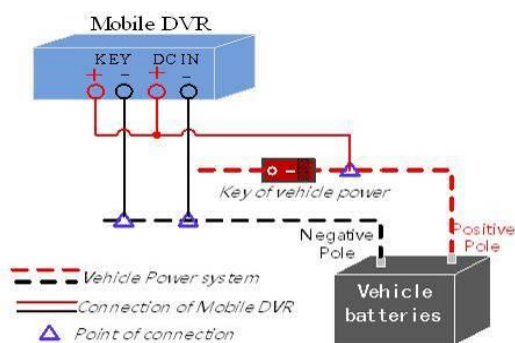

Figure 1. 6 Timing On/Off

Steps:

1. Connect the “DC IN +” and “KEY +” of mobile DVR to the positive pole of vehicle batteries.
2. Connect the “DC IN -” and “KEY -” of mobile DVR to the negative pole of vehicle batteries.

For detailed time settings of time-delay shutdown, see 10.1 Configuring Startup and Shutdown.

1.5 Alarm Input/Output Connection

1.5.1 Alarm Input Connection

DS-MP7508 series mobile DVR adopts the high/low-level electrical signals triggering (high level: 6 to 36 VDC; low level: 0 to 5 VDC) to realize alarm input. And in order to avoid error report caused by voltage fluctuation, no alarm will be triggered by voltage ranging of 5 to 6 VDC.

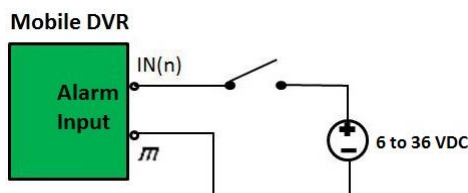

Figure 1. 7 Alarm Input Connection

1.5.2 Alarm Output Connection

An alarm device with power supply is needed. The alarm output interfaces A1 and B1 of the mobile DVR is disconnected normally. When an alarm output is triggered, the interface of corresponding A1 and B1 will be connected.

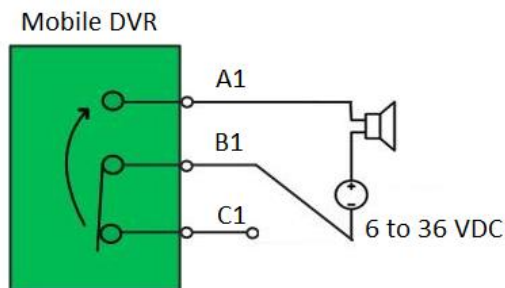

Figure 1. 8 Alarm Output Connection

1.6 HDD/SSD Installation



- Use the factory recommended 2.5-inch HDD/SSD.
- For a single HDD/SSD installation, the thickness of the HDD/SSD should be 9.5mm or 7mm; for a dual HDD/SSD installation, the thickness of each HDD/SSD should be 7mm.
- Format the HDD/SSD for recording after the installation. Otherwise, the system will give an audible warning for HDD error. For details, see *3.1.1 Formatting Storage Device*.

Perform the following steps to install the HDD/SSD on the mobile DVR.

Before you start:

Prepare the tools and components for installation: 2.5-inch SATA HDD/SSD, antistatic gloves, key of hard disk lock, cross screwdriver, and screws.

Steps:

1. Put on the antistatic gloves before the installation.
2. Insert the key and anticlockwise rotate it to unlock the hard disk lock.



Figure 1. 9 Lock Hard Disk Lock

3. Unfasten the two screws in hard disk box anticlockwise with the screwdriver and pull out the hard disk box.



Figure 1. 10 Pull Out Hard Disk Box



Figure 1. 11 Hard Disk Box

4. Fully place the first HDD/SSD into the hard disk box, with the PCB facing downward and HDD/SSD SATA and power interface facing the SATA and power interface of hard disk box.
5. Push the HDD/SSD towards the SATA and power interface of hard disk box till HDD/SSD and hard disk box are completely connected.



Figure 1. 12 Place HDD/SSD

6. Tighten the 4 set screws on the side of the hard disk box.



Figure 1. 13 Tighten Screws

-
7. Repeat the step 4 to 6 to install another HDD/SSD.
 8. Insert the hard disk box back to the mobile DVR and tighten the screws in hard disk box.

1.7 SD Card Installation

Purpose:

SD card with capacity up to 128 G can be installed.

Before you start:

Prepare the tools and components for installation: factory recommended SD card, antistatic gloves, and key of hard disk lock.

Steps:

1. Put on the antistatic gloves before the installation.
2. Insert the key and anticlockwise rotate it to unlock the hard disk lock.
3. Unfasten the two screws in hard disk box anticlockwise and pull out the hard disk box.



Figure 1. 14 Pull Out Hard Disk Box

-
4. Open the cover of SD card slot.
 5. Insert the SD card into the slot with the golden contact facing downwards and the tringle-shaped notch facing right.



Figure 1. 15 Insert SD Card

-
6. Close the SD card slot cover, plug in the hard disk box, and fasten the two screws in hard disk box clockwise.

1.8 SIM Card Installation

Purpose:

Pluggable 3G/4G wireless communication module is designed for the mobile DVR and you should install the SIM card to realize the wireless communication function. Perform the following steps to install the SIM card on the mobile DVR.

Before you start:

Prepare the tools and components for installation: SIM card, antistatic gloves, key of hard disk lock, cross screwdriver, and screws.

Steps:

1. Put on the antistatic gloves before the installation.
2. Use the screwdriver to loosen and remove the set screw on the 3G/4G and Wi-Fi module.



Figure 1. 16 Loosen Screws

-
3. Pull the 3G/4G module out of the mobile DVR.
 4. Press the yellow button on the 3G/4G module to pop up the SIM card base. And then pull the SIM card base out.

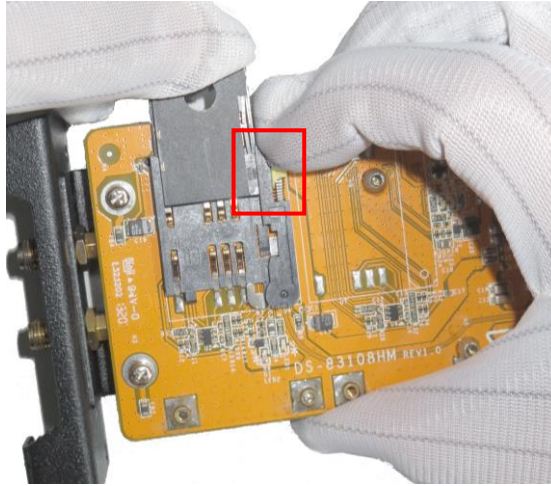

Figure 1. 17 3G/4G Module

-
5. Place the SIM card in the SIM card base correctly.



Figure 1. 18 SIM Card Base

-
6. Plug the SIM card base installed with the SIM card back to the 3G/4G module.
 7. Install the 3G/4G module component back to the mobile DVR, and tighten the set screw.



Figure 1. 19 Plug the SIM Card

-
8. Connect the 3G/4G dialing antenna to the antenna interface after the SIM card installation is complete.

Chapter 2 Basic Operations

2.1 Setting Admin Password

Purpose:

For the first-time access, you need to activate the device by setting an admin password. No operation is allowed before activation.

Steps:

1. Input the same password in the text field of **New Password** and **Confirm**.

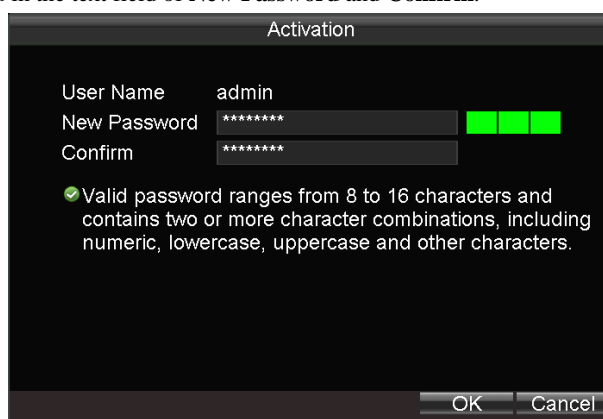

Figure 2. 1 Settings Admin Password

! STRONG PASSWORD RECOMMENDED—We highly recommend you create a strong password of your own choosing (Using a minimum of 8 characters, including at least three of the following categories: upper case letters, lower case letters, numbers, and special characters.) in order to increase the security of your product. And we recommend you reset your password regularly, especially in the high security system, resetting the password monthly or weekly can better protect your product.

2. Click **OK** to save the password and activate the device.



For the old version device, if you update it to the new version, a dialog box will pop up once the device starts up. You can click **YES** and follow the wizard to set a strong password.

2.2 Main Page

- **Enter the main page:** Press the **MENU** button, and you will enter the main page of system.
- **Operations on the main page:** Move the cursor via the direction buttons to select the menu item, and click the **Enter** button to enter the interface of the sub-menu.
- **Exit from main page:** Press the **ESC** button.

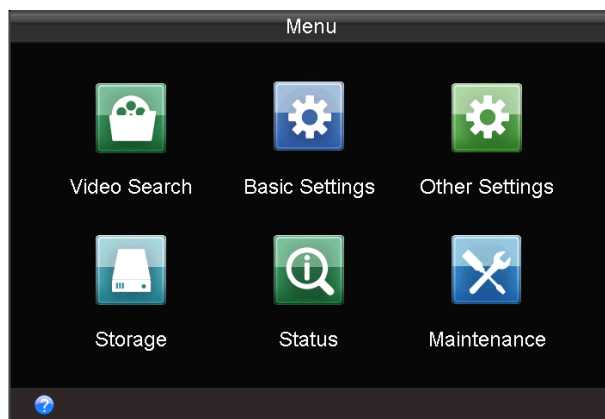

Figure 2. 2 Main Page

2.3 User Management

The admin user has all the operation permissions of the device.

Steps:

1. Enter the User Management interface.

Menu > Other Settings > User



Figure 2. 3 User Management

2. Click the **Add** button to enter the Add User interface.

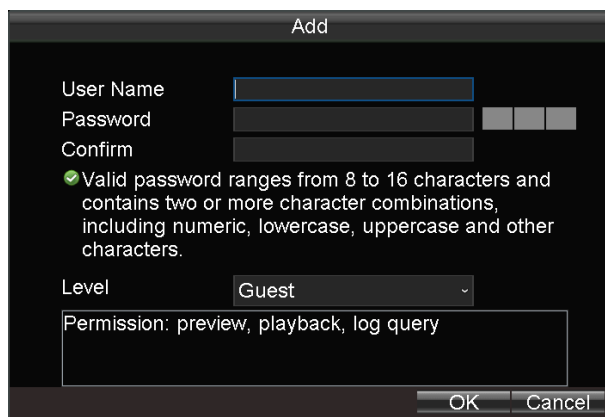

Figure 2. 4 Add User

3. Enter the information of the new user, including **User Name**, **Password** and **Confirm** password.

! STRONG PASSWORD RECOMMENDED—We highly recommend you create a strong password of your own choosing (Using a minimum of 8 characters, including at least three of the following categories: upper case letters, lower case letters, numbers, and special characters.) in order to increase the security of your product. And we recommend you reset your password regularly, especially in the high security system, resetting the password monthly or weekly can better protect your product.

4. Select the user level from the drop-down list.
 - **Operator:** The operator has permissions of Preview, Playback, Backup, and Log Search.
 - **Guest:** The Guest has permission of Preview, Playback, and Log Search.
5. Click the **OK** button to save the settings and go back to the User Management interface.
6. You can click the **Delete** button to delete the selected user and click the **Modify** button to modify the user information.

2.4 Display Settings

Purpose:

You can set the system time, select the CVBS output standard, enable the password, configure the DST settings, etc.

Steps:

1. Enter the Display Settings interface.

Menu > Other Settings > Display



The system language is set as English by default, and is not editable.

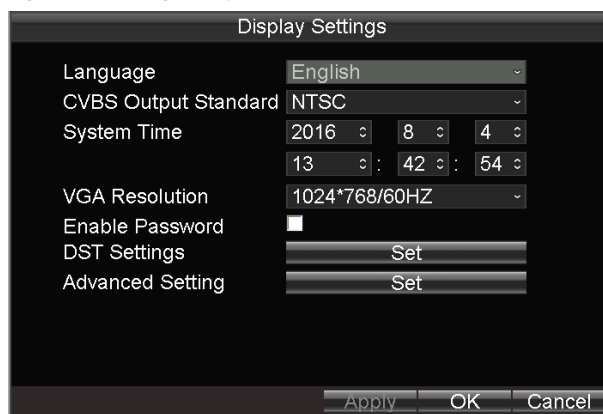

Figure 2. 5 Display Settings

2. Select the **CVBS Output Standard** to **NTSC** or **PAL** according to the actual video input standard.
3. Set the system time. You can click the **DIRECTION** keys on the remote control to positioning the cursor (**Left/Right**) and adjust the date or time (**Up/Down**).
4. Set the **VGA Resolution** in drop-down list.
5. Check the checkbox of **Enable Password** enable the password authentication before operations.
6. Click the **Set** button of DST Settings, and you can configure the DST (Daylight Saving Time) for the system. Perform the following steps to configure the DST settings.
 - 1) Check the checkbox of **Enable DST**.
 - 2) Set the start time and end time for the DST period.
 - 3) Select the DST bias from the drop-down list.
 - 4) Click **Apply** to save the settings and click **OK** to exit.

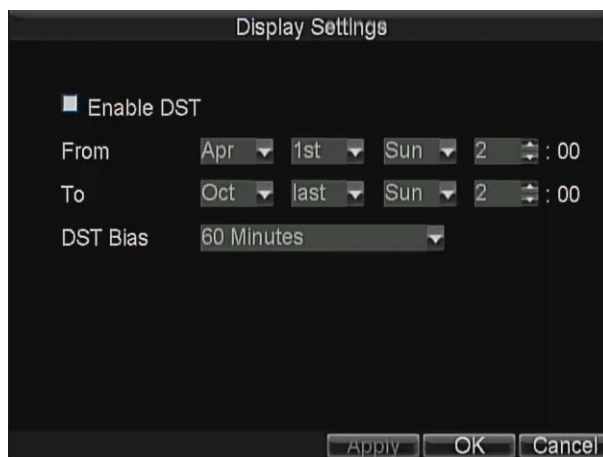

Figure 2. 6 DST Settings

7. Click the **Set** button of **Advanced Settings**, and you can configure the advanced parameters for display.
 - **Device Name:** Enter the system name as desired in the text field.
 - **Device No.:** Edit the device No. for remote control. The device No. ranges from 1 to 255. The default device No. is 255.



It is recommended not to modify the **Device No.** Otherwise, you need to input the Device No. on the remote control every time you use it.

- **CVBS Brightness:** Adjust the video output brightness.
- **Menu Transparency:** The transparency proportion of the menu displayed on the live view interface. You can set it as 1:3, 1:1, 3:1 or Non-transparent.



- The smaller the proportion value is, the more transparent the menu is.
- When the Not Transparent is selected, only the menu is displayed on the interface.

- **Operation Timeout:** If no operations are done during the selected time, the live view interface will be displayed automatically.

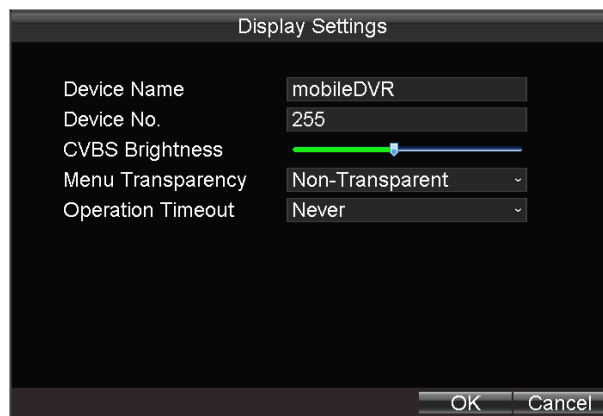

Figure 2. 7 Advanced Settings

8. Click **Apply** to save the settings and click **OK** to exit.

2.5 Camera Settings

Purpose:

You can configure the camera name, OSD (On Screen Display) settings, etc.



The settings of OSD, standing for On Screen Display, include the display of camera name, date and week and the corresponding position information.

Steps:

1. Enter the Camera Settings interface.

Menu >Other Settings > Camera



Figure 2. 8 Camera Settings

2. Select the camera from the drop-down list.
3. Enter the camera name as desired in the text field.
4. Check the checkboxes to **Display Camera Name**, **Display Date** or **Display Week** on the live view interface of selected camera.
5. Select the date format and time format according to the actual needs, and then select the **OSD Property**.
6. Click the **OSD Position** button and use the **F2** key and **Direction** keys on remote control to adjust the **OSD Position**.
7. Click the **Set** button of **More Setting**, and you can configure the video parameters, mask area, motion detection, etc.

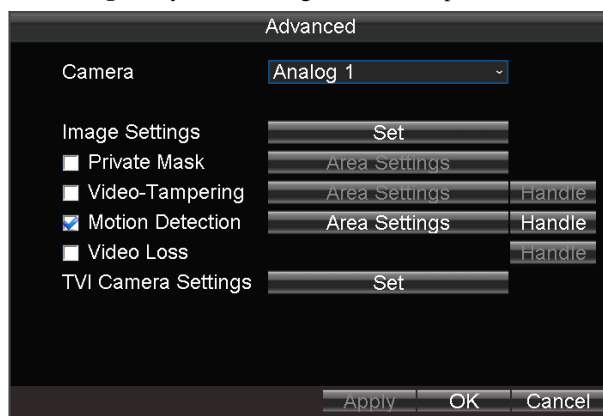

Figure 2. 9 More Setting

➤ **Image Settings**

Perform the following steps to adjust the video parameters, including Brightness, Contrast, Saturation and Hue.

- 1) Click the **Set** button of Image Settings to enter the Image Settings interface.
- 2) Select the parameter item, press **Enter** key on the remote control, and use the **Direction** keys to adjust the value of the selected item.
- 3) You can click **Default** to restore the default video parameters.
- 4) Click **OK** to save the new settings.



Figure 2. 10 Image Settings Interface

➤ Private Mask

The privacy mask can be set to prevent some certain spots in the surveillance area from being viewed or recorded. Perform the following steps to set a privacy mask:

- 1) Check the checkbox of **Mask** to enable the privacy mask function.
- 2) Click the **Area Settings** button to set the mask area on the live view interface.
- 3) Press the **Edit** key on the remote control and a red block appears on the screen.
- 4) Press the **Direction** keys on the remote control to adjust the position of the red block.
- 5) Press the **Enter** key on the remote control to save the position of the red block.
- 6) Press the **Direction** keys on the remote control to adjust the size of the block.
- 7) Press the **Enter** key on the remote control to save the size of the block.
- 8) You can press the **A** key on the remote control to clear all the mask areas.



- Up to 4 mask areas can be configured for each channel.
- The mask area information of one channel cannot be copied to another one.
- You cannot view the image of the mask area either from the live view interface or record files.
- The screen is divided into 22*18 blocks in PAL format and 22*15 blocks in NTSC format.

➤ Video-Tampering Detection

The video-tampering alarm is triggered when the camera is covered and the monitoring area cannot be viewed. Linkage actions including audible warning, alarm output, etc., can be set to handle it. For details, see *11.2.3 Configuring Video-Tampering Alarm*.

➤ Motion Detection

A motion detection alarm is triggered when the client software detects motion within its defined area. Linkage actions including audible warning, alarm output, etc., can be set to handle it. For details, see *3.2 Configuring Motion Detection Record*.

➤ Video Loss Detection

When the device cannot receive video signal from the front-end devices, the video loss alarm will be triggered. Linkage actions including audible warning, alarm output, etc., can be set to handle it. For details, see *11.2.4 Configuring Video Loss Alarm*.

➤ TVI Camera Settings: You can configure the **Mirror** type, **Brightness**, **Saturation**, **Day/Night Switch**, **Color to B/W Sensitivity**, and **B/W to Color Sensitivity** of connected TVI camera.

8. Optionally, you can select the camera and click **Copy** to copy the current settings to the selected camera.
9. Click **Apply** to save the new settings and click **OK** to exit.

2.6 Preview Settings

Purpose:

You can configure the dwell time of live view window, set the camera order, enable/disable the audio preview, etc.

Steps:

1. Enter the Preview Settings interface.

Menu > Other Settings > Preview

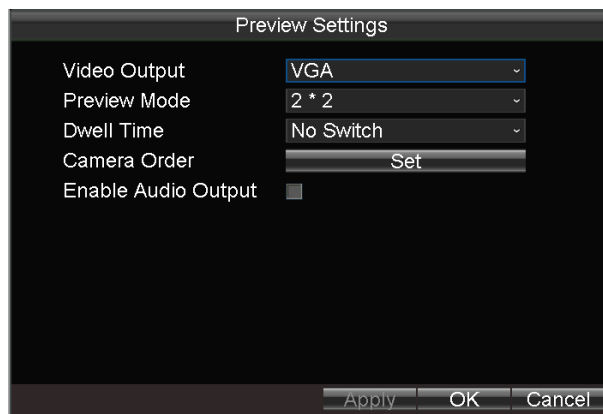

Figure 2. 11 Preview Settings

2. Select the **Video Output** from the drop-down list according to the actual needs.
3. Select the preview mode, dwell time for live view, and then enable/disable the audio output.
 - **Preview Mode:** select the window division mode for live view.
 - **Dwell Time:** the switch interval of the live view screen. The screen will be switched to the next one after the selected dwell time.
 - **Enable Audio Output:** Enables/disables audio output for the selected video output.
4. Click the **Set** button to set the camera order.

Perform the following steps to set the camera order for display:

- 1) Press **Direction** keys on the remote control to select the display window.
- 2) Press **Enter** key on the remote control to enter the edit mode.
- 3) Press **Direction** keys on the remote control to select the camera for display.



The character “X” means no camera will be displayed on the selected window.

- 4) Press **Enter** key on the remote control to confirm the settings.
- 5) Click **OK** to save the new settings and exit.

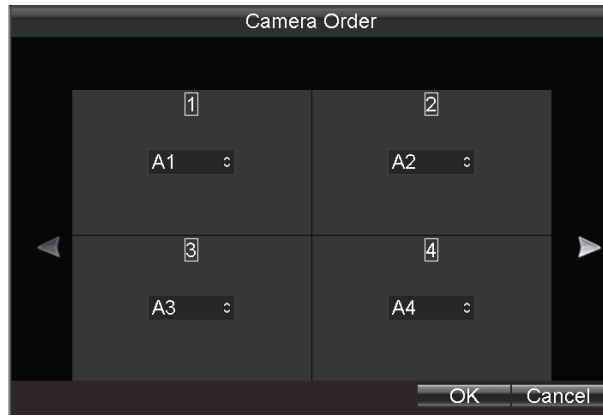

Figure 2. 12 Camera Order

5. Click the **Apply** button to save the new settings and click **OK** to exit.

Chapter 3 Record Settings

3.1 Configuring Encoding Parameters

3.1.1 Formatting Storage Device

Before you start:

Install at least one HDD/SSD or SD card on the mobile DVR for video data storage.

Steps:

1. Enter the storage management interface.

Menu > Storage

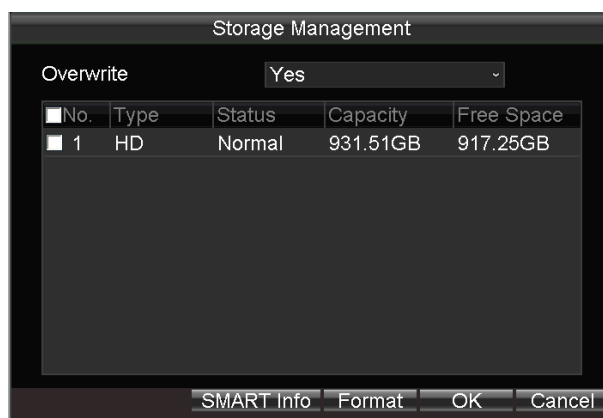

Figure 3. 1 Hard Disk Management

2. Check the checkbox of the storage device to format.



- If the storage device is installed correctly and formatted, the status is displayed as normal or sleeping.
- The overwriting function is enabled by default. If the overwriting function is disabled, the recording will stop when the storage device is full.

3.1.2 Configuring Record Settings

Purpose:

You can configure the transmission stream type, the resolution, frame rate, etc.

Steps:

1. Enter the Record Settings interface.

Menu > Basic Settings > Record



Figure 3. 2 Record Settings

2. Select the camera from the drop-down list.
3. Configure the following settings:
 - **Encoding Parameters**
 - Main Stream (Normal): used for schedule recording;
 - Main Stream (Event): used for event recording;
 - Sub-Stream: used for network transmission.
 - **Stream Type**
 - Video and Video & Audio are selectable.
 - **Resolution**
 - Select the resolution for the selected camera and stream type. 1080p, 720p, WD1, and 4CIF are selectable.
 - **Bitrate Type**
 - Variable and Constant are selectable.
 - The video quality is configurable when you select Variable to the bitrate type; and the video quality is set as Medium by default and cannot be edited when you select Constant to the bitrate type.
 - **Video Quality**
 - If you select Variable to the bitrate type, you can set the video quality as Highest, Higher, Medium, Low, Lower and Lowest.
 - **Frame Rate**
 - Frame rate refers to the frequency of the image frame after compression. With other parameters constant, reduce the video frame rate, and you can lower the maximum bitrate to some extent.
 - **Max. Bitrate(Kbps)**
 - Select the fixed value provided by the system or customize the maximum bitrate as desired.
4. Click the **Set** button of **Schedule** to enter the record schedule interface.
 - 1) Check the check box of **Enable Schedule** to enable the record schedule settings.
 - 2) Select a day from the drop-down list for settings.
 - 3) Check the checkbox of **All-Day** to enable all-day recording, and then select the recording **Type** from the drop-down list.
 - Or you can uncheck the checkbox of **All-Day**, customize the time period for recording, and select the recording type for each time period.
 - 4) Click **OK** to save the new settings and exit.

You can view the recording status on the Record Status interface (Menu > Status > Record).



- 5 recording types are selectable: **Normal, Motion Detection, Alarm, Motion | Alarm and Motion & Alarm.**
- Up to 8 time periods can be set for each day and each of the time periods cannot be overlapped.

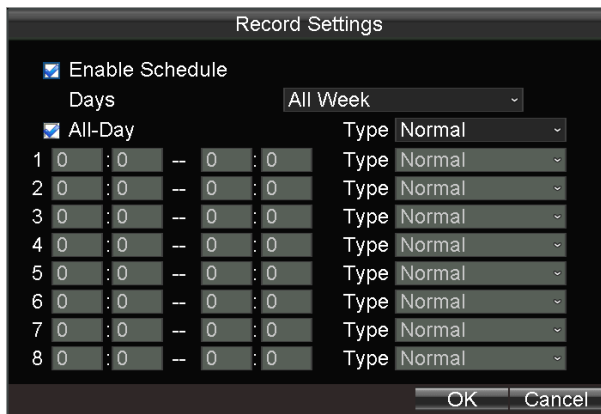

Figure 3. 3 Record Schedule Settings

5. Click the **Set** button of **More Settings** to configure the pre-record and post-record time.
 - **Pre-Record:** Normally used for the event (motion or alarm) triggered record, when you want to record before the event happens. For example, when an alarm occurs at 10:00, if the pre-record time is set as 5 seconds, the camera records the alarm at 9:59:55.
 - **Post-Record:** After the event finished, the video can also be recorded for a certain time. For example, when an alarm ends at 11:00, if the post-record time is set as 5 seconds, the camera records till 11:00:05.
6. Optionally, you can select the camera and click **Copy** to copy the current settings to the selected camera.
7. Click **Apply** to save the settings and click **OK** to exit.

3.2 Configuring Motion Detection Record

Purpose:

In the motion detection record, once a motion event occurs, the device starts to record and multiple linkage actions will be triggered.

Steps:

1. Enter the Advanced Camera Settings interface.
Menu > Other Settings > Camera > Set (More Setting)

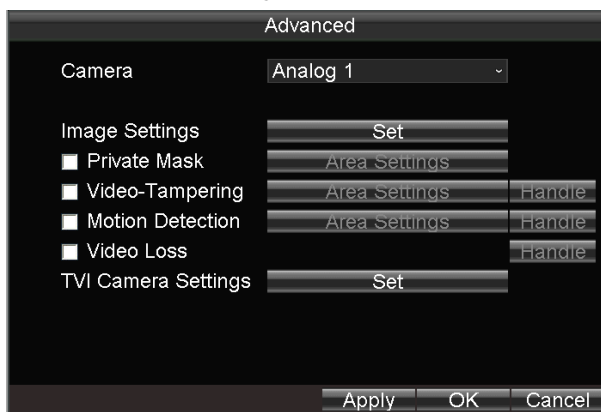

Figure 3. 4 Motion Detection Settings

2. Check the checkbox of **Motion Detection** to enable the motion detection function.

3. Click the **Area Settings** button to set the area for motion detection.
 Perform the following steps to set a specified area for motion detection:
 - 1) Press the **Edit** key on the remote control and a red block appears on the screen.
 - 2) Press the **Direction** keys on the remote control to adjust the position of the red block.
 - 3) Press the **Enter** key on the remote control to save the position of the red block.
 - 4) Press the **Direction** keys on the remote control to adjust the size of the block.
 - 5) Press the **Enter** key on the remote control to save the size of the block.
 - 6) Press the **Menu** key on the remote control to set the detection sensitivity. You can set the level as 1~6 or off. Click **OK** to save the settings.
 - 7) You can press the **A** key on the remote control to clear all the mask areas.
 - 8) Press the **Enter** key on the remote control to save the settings and then press **Esc** key to exit.
4. Click the **Handle** button of Motion Detection, and you can set the arming schedule and alarm linkage actions.
 Perform the following steps to set the arming schedule and alarm triggered linkage actions:
 - 1) Select the day from the drop-down list, and set the arming schedule for the alarm linkage actions.
 - 2) Optionally, you can copy the current settings to other days in the week.
 - 3) Check the checkboxes to enable the corresponding linkage actions.
 - **Full Screen Monitoring**
 When an alarm is triggered, the local monitor displays the video image from the alarming channel configured for full screen monitoring.
 - **Audible Warning:**
 Trigger an audible *beep* when an alarm is detected.
 - **Trigger Alarm Output:**
 Trigger an alarm output when an alarm is detected. For details of alarm output settings, see *11.2.2 Configuring Alarm Output*.
 - 4) Click the **Set** button of **Triggered Camera** to select the channel to be triggered.
 - 5) Click **Apply** to save the new settings and click **OK** to exit.

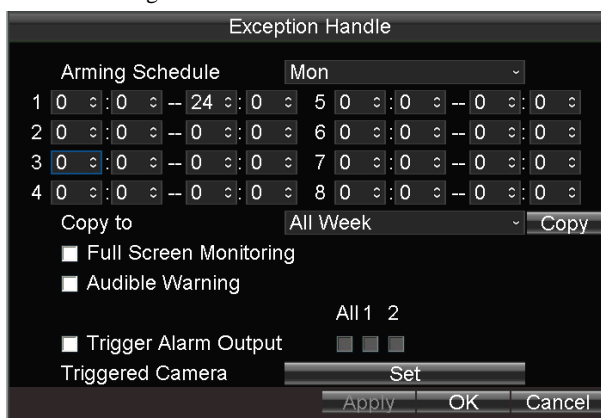

Figure 3. 5 Linkage Actions of Motion Detection

5. Click **Apply** to save the new settings and click **OK** to exit.
6. Enter the Record Settings interface, and select Motion as the record type to set the arming schedule of motion detection record. For details, refer to *3.1.2 Configuring Record Settings*.

3.3 Configuring Alarm Triggered Record

Purpose:

Follow the procedure to configure alarm triggered recording.

Steps:

1. Enter the Alarm Input settings interface.

Menu > Other Settings > Alarm In

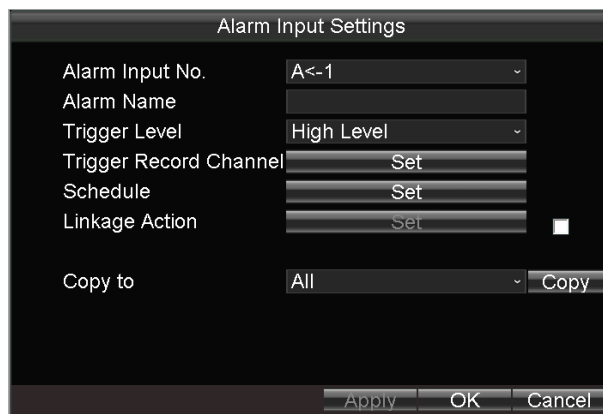

Figure 3. 6 Alarm Input Settings

2. Click the **Set** button of **Trigger Record Channel** to select the alarm triggered recording channel(s). For other alarm input settings, see *11.2.1 Configuring Alarm Input*.
3. Click the **Apply** button to save the settings and click **OK** to exit.
4. After configuring alarm input, enter the Record Settings interface to set alarm triggered record. For details, refer to *3.1.2 Configuring Record Settings*.

Chapter 4 Playback

4.1 Playing Back General Video

Purpose:

General video includes normal, motion detection, alarm, motion and alarm, and motion or alarm video.

4.1.1 Playback by Camera and Time

Steps:

1. Enter Video Search interface.

Menu > Video Search

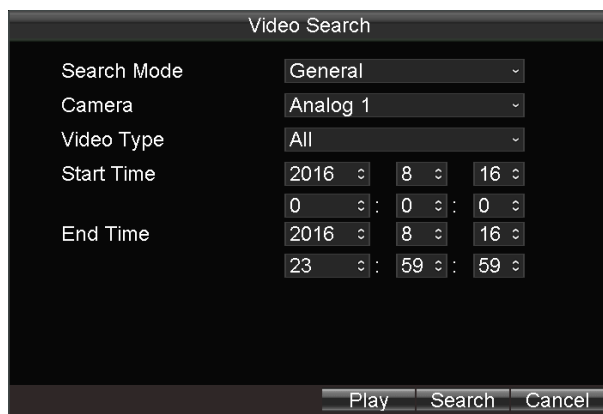

Figure 4. 1 Video Search

2. Select **Search Mode** as **General**.
3. Specify **Camera**, **Start Time**, and **End Time** to play back.
4. Click **Play** to start playback.
 - Press the **Up/Down** keys on the remote control to adjust speed up/speed down.
 - Press **Left/Right** keys on the remote control to jump forward/reverse for 30 seconds.

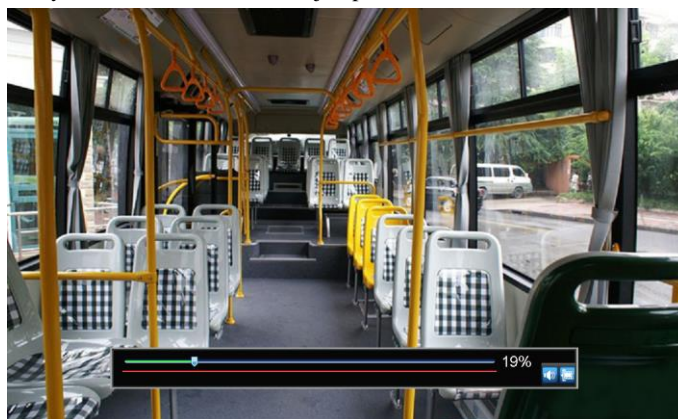



Figure 4. 2 Playback

Table 4. 1 Playback Control Panel Description

Button	Description
	Mute/Audio on
	Start/End clipping.

4.1.2 Playback by Video

Steps:

1. Enter Video Search interface.
Menu > Video Search

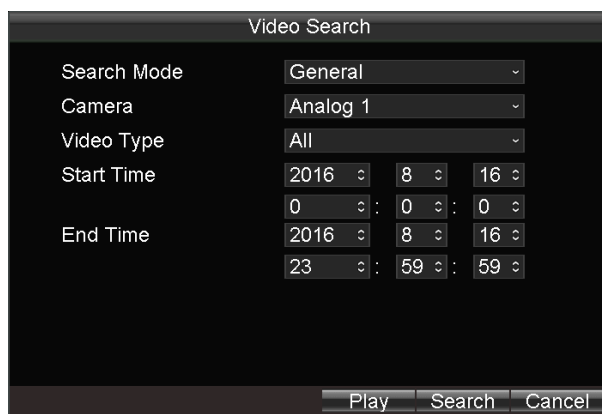

Figure 4. 3 Video Search

2. Select **Search Mode** as **General**.
3. Specify **Camera**, **Video Type**, **Start Time**, and **End Time** to search.
4. Click **Search**. And then search result will be listed.



When more than 4000 record files are found, the top 4000 items have the priority to be played back.

Search Results			
Ch...	Start Time	End Time	Size
■ A1	08-16-2016 09:57:08	09:57:20	836 KB
■ A1	08-16-2016 09:57:23	09:57:52	1,211 KB
■ A1	08-16-2016 09:58:11	09:58:34	1,573 KB
■ A1	08-16-2016 09:58:40	10:01:10	5,851 KB
■ A1	08-16-2016 10:01:47	10:02:03	1,396 KB
■ A1	08-16-2016 10:02:10	10:02:29	970 KB
■ A1	08-16-2016 10:02:36	10:03:05	1,387 KB
■ A1	08-16-2016 10:03:12	10:03:44	1,496 KB
■ A1	08-16-2016 10:04:44	10:05:07	1,609 KB
■ A1	08-16-2016 10:05:22	10:05:37	1,134 KB
■ A1	08-16-2016 10:05:45	10:05:58	780 KB
Total Size: 0KB			
<input type="button" value="Play"/> <input type="button" value="Export"/> <input type="button" value="Cancel"/>			

Figure 4. 4 Search Results

- Click to select a video and click **Play** to start playback the video.

4.2 Playing Back Event Video

Purpose:

Five event types are provided, including alarm input, manual alarm, speeding alarm, G-sensor event, and sensor-in event. For the five events, when an event happens, all the cameras whose normal recording enabled will be triggered to record the event video.



Alarm input video is triggered by alarm input. Manual alarm is triggered by alarm terminal.

Steps:

- Enter Video Search interface.

Menu > Video Search

Video Search	
Search Mode	Event
Event Type	Alarm Input
Alarm No.	All
Start Time	2016 : 9 : 19
End Time	2016 : 9 : 19 : 23 : 59 : 59
Search Cancel	

Figure 4. 5 Video Search

- Select **Search Mode** as **Event**.
- Specify **Event Type** and other search conditions.
- Click **Search** and then search results will be listed.
- Select the **Pre-Play** and **Post-Play** time.
 - Pre-play:** the time you set to play back before the video. For example, if the recorded video starts at 10:00:00 and the pre-play time is 30 seconds, the video starts at 9:59:30 during playback.
 - Post-play:** the time you set to play back after the video. For example, if the recorded video starts at 10:00:00 and the post-play time is 30 seconds, the video ends at 10:00:30 during playback.
- Click to select an event, click **Play** to select camera to play back. After cameras are selected, click **OK** to start playback.

Chapter 5 Video Backup

Purpose:

You can back up the general videos.

Steps:

1. Enter the Video Search interface.

Menu > Video Search

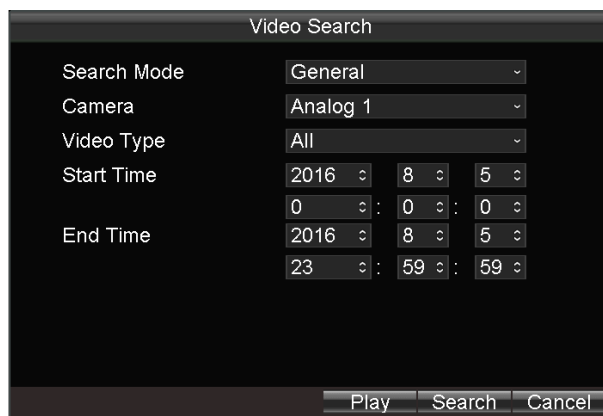

Figure 5. 1 Video Search Interface

2. Select the **Search Mode** as **General**.
3. Select the **Camera** and **Video Type**, and specify the **Start Time** and **End Time** for search.
4. Click the **Search** to display search result.
5. Click the **Search** button, and the record files will be displayed on a list.
6. Check the checkboxes of videos and click the **Export** button to start exporting.

Chapter 6 PTZ Controls

6.1 Configuring PTZ Settings

Purpose:

Follow the procedure to set the parameters for PTZ. The configuring of the PTZ parameters should be done before you control the PTZ camera.

Before you start:

Connect the RS-485 cables of PTZ camera to device **EXT.DEV** interface.

Steps:

1. Enter the PTZ Settings interface.

Menu > Other Settings > PTZ

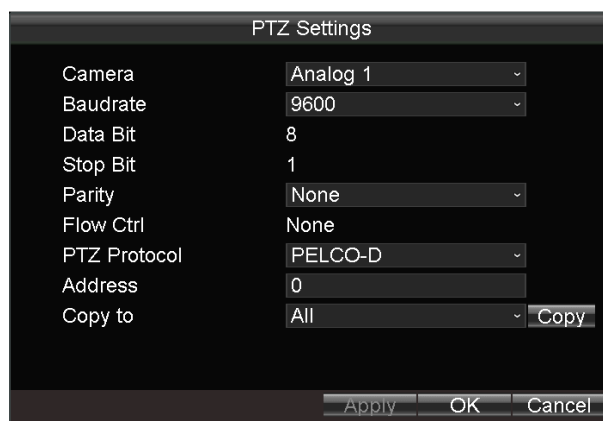

Figure 6. 1 PTZ Settings

2. Choose the camera for PTZ setting in the **Camera** dropdown list.
3. Enter the parameters of the PTZ camera.



All the parameters should be exactly the same as the PTZ camera's parameters.

4. Click **OK** button to save the settings.

6.2 PTZ Control Panel

Right-click a PTZ camera and click **PTZ** on the popup right-click menu to enter the PTZ Control interface.

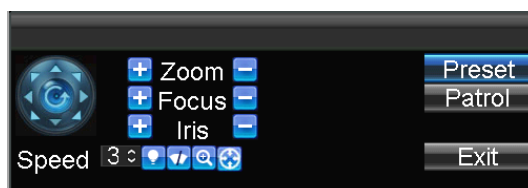









Figure 6. 2 PTZ Control Panel

Table 6. 1 Description of PTZ Control Panel

Icon	Description	Icon	Description	Icon	Description
	Direction button and the auto-cycle button		Zoom+, Focus+, Iris+		Zoom-, Focus-, Iris-
	Moving speed		Light on/off		Wiper on/off
	3D-Zoom		Image Centralization		

Chapter 7 Wireless Network Settings

7.1 Dialing Settings

Before you start:

Install a 3G/4G SIM card on the device.



Dialing function is only supported by DS-MP7508/GW, DS-MP7508/GW/WI, and DS-MP7508/GLF/WI series.

Steps:

1. Enter the 3G/4G Dialing Settings interface.

Menu > Basic Settings > Dial

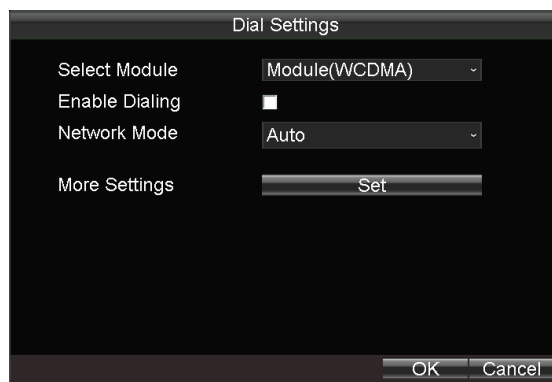

Figure 7. 1 Dialing Settings

2. Check the checkbox of **Enable Dialing** to enable the dialing function of the device.
3. Select **Network Mode** as **Auto**, **Auto-Search and Auto-Switch**, or **3G Only** in the dropdown list.
 - **Auto:** the work mode is set as the detected stronger signal.
 - **Auto-Search and Auto-Switch:** As long as 3G signal is detected, even if it is weak, the work mode is 3G mode.
 - **3G Only:** the network mode is set as 3G mode, that is 2G mode is not available.
 - **4G Only:** the network mode is set as 4G mode, that is 3G mode is not available.
4. To configure the VPDN (Virtual Private Dialup Network) settings, you can click the **Set** button of **More Settings**, input the access point name (APN), dialing number, username and password, select the authentication type, and then click **OK** to save the settings.



Please contact the local operator and consult the network parameters of the VPDN.

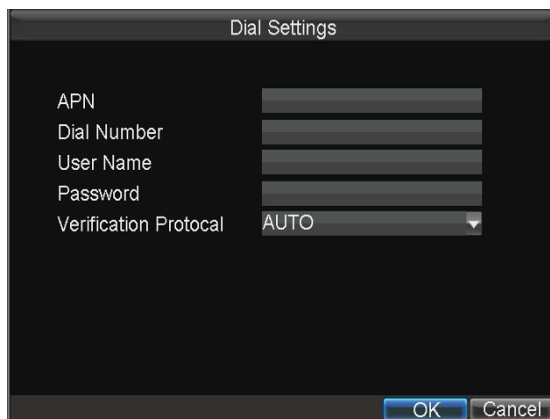

Figure 7.2 Private Network Settings

- Click **OK** and reboot the device to activate the new settings.
You can view the dialing status on the Dialing Status interface (Menu > Status > Dial).

7.2 Wi-Fi Settings

Purpose:

You can connect the device to the Wi-Fi networks and transmit the data via the Wi-Fi.



Wi-Fi function is only supported by DS-MP7508/GW/WI and DS-MP7508/GLF/WI series.

Steps:

- Enter the Wi-Fi Settings interface.
Menu > Basic Settings > WiFi

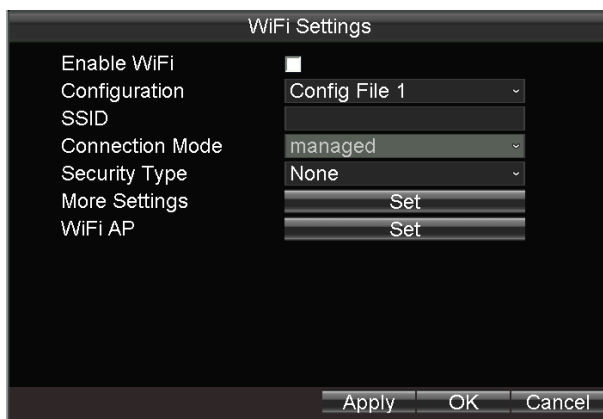

Figure 7.3 Wi-Fi Settings

- Check the checkbox of **Enable WiFi** to enable the Wi-Fi settings.
- Select the **Configuration** file, and set the network **SSID** (Service Set Identifier), **Security Type**, **Encryption Type**, and **Key**.



5 configuration files are available and only one SSID can be set for each file.

- Click the **Set** button of **More Settings**, and you can set the IP address and DNS server for Wi-Fi network.

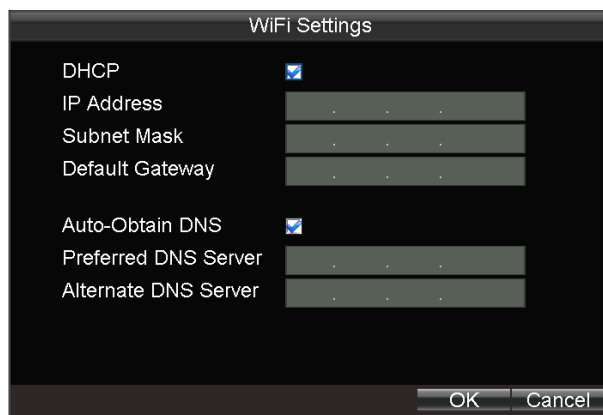

Figure 7. 4 IP & DNS Settings for Wi-Fi



Check the checkbox of **DHCP** and **Auto-Obtain DNS** to obtain IP address and DNS server for Wi-Fi network automatically.

5. Click the **Set** button of **WiFi AP**, and you can configure the settings of Wi-Fi access point.
 - **Enable WiFi AP**: once enabled, the device can work as a wireless router.
 - **Enable WiFi Broadcast**: once enabled, other devices are able to detect the SSID of the device.
 - **Enable WiFi Hotspot**: enable it to share the device's internet connection. Other devices can access to internet via joining the hotspot.



Figure 7. 5 Wi-Fi Access Point Settings

6. Click **Apply** to save the new settings and click **OK** to exit.
You can view the Wi-Fi status on the Wi-Fi Status interface (Menu > Status > WiFi). Click the **Query** button to search the available access points of Wi-Fi network, including SSID, Security Type and Signal Strength.

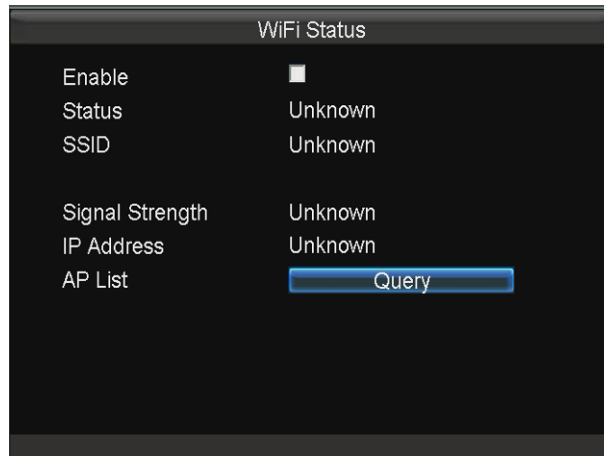

Figure 7. 6 Wi-Fi Status Interface

Chapter 8 Storage

Steps:

1. Enter Storage management interface.
Menu > Storage
- To keep writing data into storage device even when it is full, you can select **Overwrite** as **Yes** to enable overwrite function for all storage device, or select it as **No** to disable it. Overwrite is turned on by default.
- You can view the SMART Info of a storage device by checking its checkbox and click **SMART Info** button.

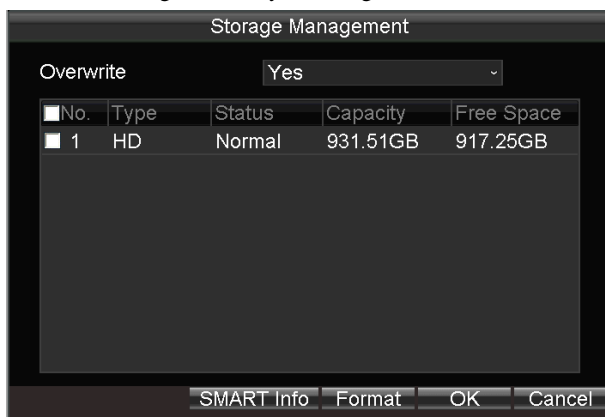

Figure 8. 1 Storage Management

Chapter 9 Platform Settings

Purpose:

The Mobile DVR can be remotely accessed via iVMS platform. Make sure the parameters configured are valid for the platform you select for login.

Steps:

1. Enter the Platform Settings interface.
Menu > Basic Settings > Platform
2. Select Platform iVMS as the current platform from the drop-down list.

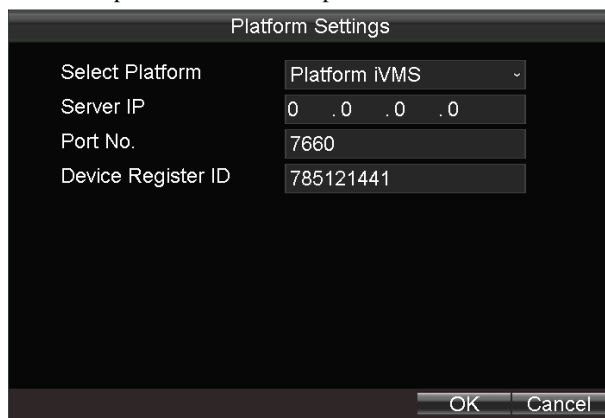

Figure 9. 1 iVMS Platform Settings

3. Configure the following parameters:
 - **Server IP:** Enter the static IP address of iVMS server.
 - **Port No.:** The default value is 7660.



The Device ID is the same as the device serial number. You can use the Device ID when login via iVMS platform.

4. Click **OK** and reboot the device to activate the new settings.
You can view the platform status on the Platform Status interface (Menu > Status > Plat).

Chapter 10 Mobile Specified Functions

10.1 Configuring Startup and Shutdown

Purpose:

You can set the shutdown delay time (Vehicle Ignition Startup and Shutdown) or specify the startup/shutdown time (Timing On/Off) for the mobile DVR.

➤ **For Vehicle Ignition Startup and Shutdown**

Steps:

1. Enter the Start Control interface.
Menu > Basic Settings > Start
2. Select **Start/Shutdown Mode** as **Halt Delay** from the drop-down list.
3. Select the **Delay Time** for device shutdown. The delay time ranges from 0 min to 6 hours.
4. Optionally, check the checkbox of **Voltage Protect** and then select the voltage limit percent. Once the voltage of the device reaches the selected threshold, the device will shut down automatically.
5. Click **OK** to save the new settings and exit.

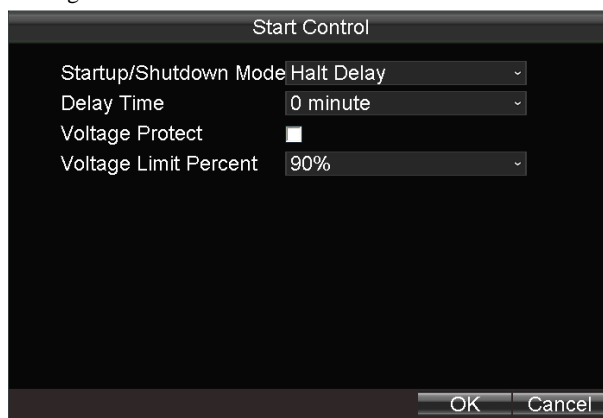

Figure 10. 1 Start Control-Halt Delay

➤ **For Timing On / Off**

Steps:

1. Enter the Start Control interface.
Menu > Basic Settings > Start
2. Select **Start/Shutdown Mode** as **Scheduled Startup/Shutdown** from the drop-down list.
3. Select the day on which you want to start up/shut down the device automatically.
4. Specify the **Time Segment** for the device to start up and shut down.
5. Optionally, you can copy the settings to other days in the week.
6. Click **OK** to save the new settings and exit.



Two periods can be configured for each day. And the time periods can't be overlapped each other.

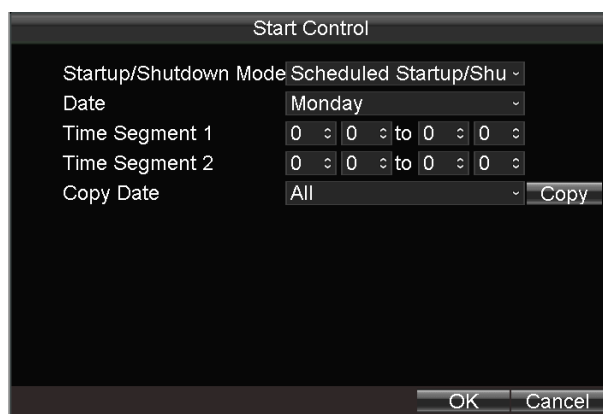

Figure 10. 2 Start Control-Auto Working

10.2 Configuring Satellite Positioning

Purpose:

The built-in GNSS module supports GPS (Global Positioning System), contributing to the device positioning and speed limit alarm.

Steps:

1. Enter the Satellite Positioning Settings interface.

Menu > Basic Settings > Position

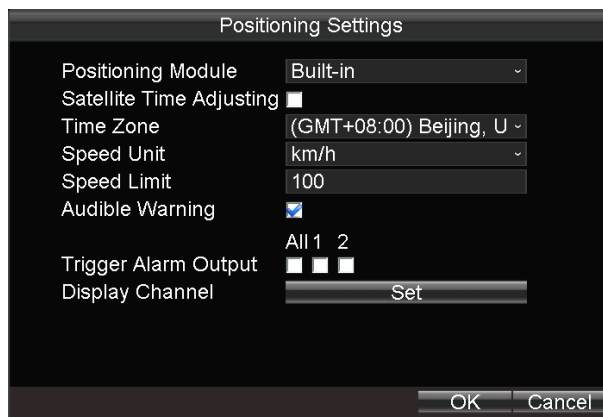

Figure 10. 3 Satellite Positioning Settings

2. Select the mode of the **Positioning Module**. Four modes of positioning module are selectable.
 - **RS-232**: Obtain data from the satellite positioning module connected through RS-232 interface.
 - **RS-485**: Obtain data from the satellite positioning module connected through RS-485 interface.
 - **Built-in**: Obtain data from the satellite positioning module built in the mobile DVR.
 - **Display Terminal**: Obtain data from display terminal.
3. Check the checkbox of **Satellite Time Adjusting** and then select the time zone in which the device locates.
4. Select the **Speed Unit** and input the **Speed Limit** value.
5. Set the linkage actions for speeding alarm, including **Audible Warning** and **Alarm Output**. For details of alarm output settings, see *11.2.2 Configuring Alarm Output*.

6. Click the **Set** button of **Display Channel**, check the checkboxes of display channels, and click **OK** to go back to upper menu. Then the device positioning information will be displayed on the selected channels.
7. Click **OK** to save the new settings and exit.

You can view the device positioning status on the Positioning Status interface (Menu > Status > Position).

10.3 Configuring G-Sensor Alarm

Purpose:

G-Sensor detects and records the acceleration speed information in 3-axial (X, Y, Z) directions.

Before you start:

Connect an external sensor to the device for obtaining and providing the acceleration speed in 3-axial directions.

Steps:

1. Enter the G-Sensor Settings interface.

Menu > Basic Settings > G-Sensor

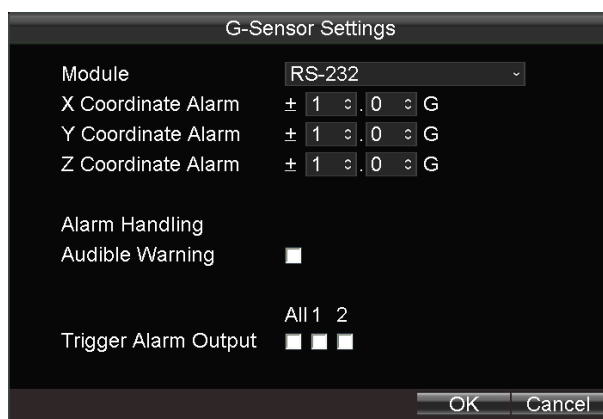

Figure 10. 4 G-Sensor Settings

2. Select the mode of G-sensor **Module**. 2 modes of G-sensor module are selectable.
 - **RS-232:** The G-sensor is connected to the mobile DVR through RS232 interface.
 - **Built-in:** The G-sensor is built in the mobile DVR
3. Set the limit value for acceleration alarm in X, Y and Z directions.



X, Y and Z represent the direction of acceleration and the unit of alarm value is G ($G=9.8 \text{ m/s}^2$).

4. Set the linkage actions for acceleration alarm, including **Audible Warning** and **Alarm Output**. For details of alarm output settings, see *11.2.2 Configuring Alarm Output*.
5. Click **OK** to save the new settings and exit.

You can view the G-sensor status on the G-sensor Status interface (Menu > Status > G-sensor).

10.4 Configuring Sensor-in

Purpose:

Sensor-in detects and records the driving information of the vehicle, including pedal braking, turning left/right, reversing, etc.

Steps:

1. Enter the Sensor-In Settings interface.

Menu > Basic Settings > Sensor-In

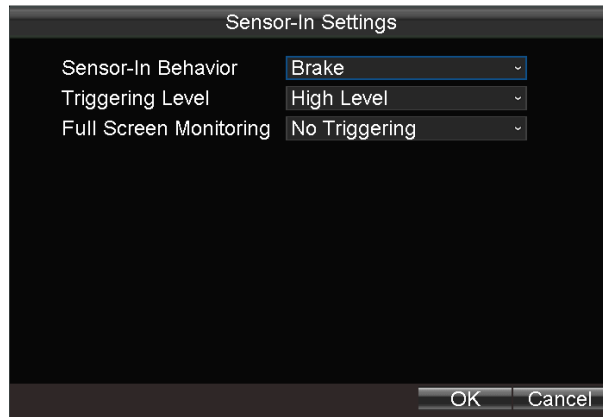

Figure 10. 5 Sensor-In Settings

2. Select the **Sensor-in Behavior** to configure.
3. Sensor-In is triggered by high or low level. Select the **Triggering Level** in dropdown list.
4. You can select the **Full Screen Monitoring** channel when sensor-in behavior is triggered.
5. Click **OK** to save the settings.

Chapter 11 Other Functions

11.1 Local Network Settings

Steps:

1. Enter the Local Network Settings interface.

Menu > Basic Settings > Network

Network Settings	
IP Address	192 . 168 . 1 . 64
Subnet Mask	255 . 255 . 255 . 0
Default Gateway	.
Preferred DNS Server	.
Alternate DNS Server	.
Downloading Server IP	.
MAC Address	5f:10:b6:73:ca:2d
Static IP Address	192.168.1.65
NTP	Set

Apply OK Cancel

Figure 11. 1 Local Network Settings

2. Enter the device **IP Address**, **Subnet Mask**, **Default Gateway**, **DNS Server** address and **Downloading Server IP** in the corresponding text fields.



- The IP address of the device should be unique in the network and the default value is 192.168.1.64.
 - The downloading server IP should be set if you want to upload the videos to the designate server.
3. Click the **Set** button of **NTP**, and you can configure the NTP (Network Time Protocol) settings for the device.

Perform the following steps to configure the NTP settings:

- 1) Check the checkbox of **NTP** to enable the NTP settings.
- 2) Enter the **Synchronization Interval**.
- 3) Enter the IP address of **NTP server**.
- 4) Click **OK** to save the new settings and exit.

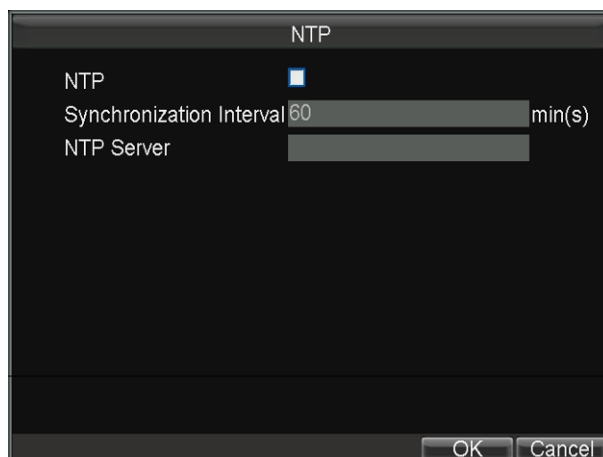

Figure 11. 2 NTP Settings

- Click **Apply** to save the new settings and click **OK** to exit.

11.2 Alarm Settings

11.2.1 Configuring Alarm Input

Purpose:

Configure the settings for alarm input, including trigger level, arming schedule, alarm linkage actions, etc.

Steps:

- Enter the Alarm Input Settings interface.

Menu > Other Settings > Alarm In

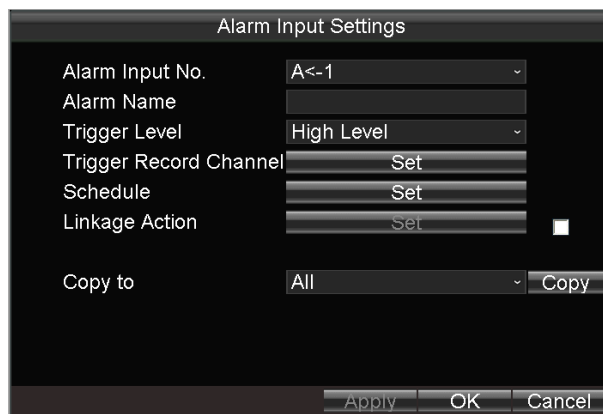

Figure 11. 3 Alarm Input Settings

- Select the **Alarm Input No.**, input the **Alarm Name** as desired in the text field, and then set the **Trigger Level** of the alarm input according to the actual needs.



- Four alarm inputs, which are triggered by high/low level (high level: 6 to 36 VDC; low level: 0 to 5 VDC), are selectable.
- In order to avoid error report caused by voltage fluctuation, no alarm will be triggered by voltage ranging from 5

to 6 VDC.

3. Click the **Set** button of **Trigger Record Channel** to select the alarm triggered recording channel(s). The selected channel(s) will start recording when a connected alarm input occurs.
4. Click the **Set** button of arming **Schedule** to set the arming schedule for alarm inputs. Up to 8 time periods can be set within each day. Optionally, you can click **Copy** to copy the current settings to other days in the week.

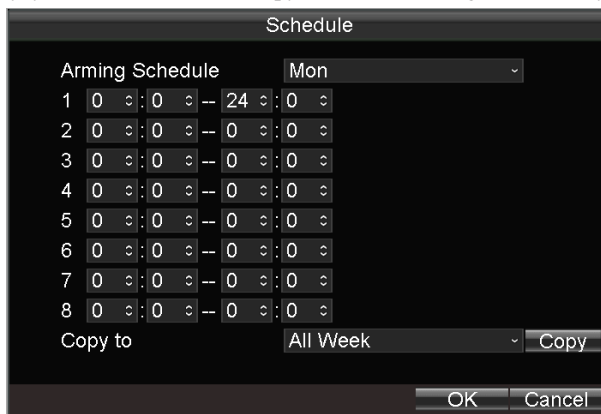

Figure 11.4 Arming Schedule

5. Check the checkbox of **Linkage Action** and click the **Set** button, and you can configure the alarm linkage actions, including **Full Screen Monitoring**, **Audible Warning**, and **Trigger Alarm Output**.

➤ **Full Screen Monitoring**

When an alarm is triggered, the local monitor displays the video image of the triggered recording channel.

➤ **Audible Warning:**

The device sends out a continuous *beep* when an alarm input is detected.

➤ **Trigger Alarm Output:**

Trigger an alarm output when an alarm when an alarm input is detected.



Figure 11.5 Alarm Linkage Action

6. Click **Apply** to save the new settings and click **OK** to exit.

11.2.2 Configuring Alarm Output

Purpose:

You can configure the arming schedule, alarm duration time, alarm name for alarm output.

Steps:

1. Enter the Alarm Output Settings interface.

Menu > Other Settings > Alarm Out

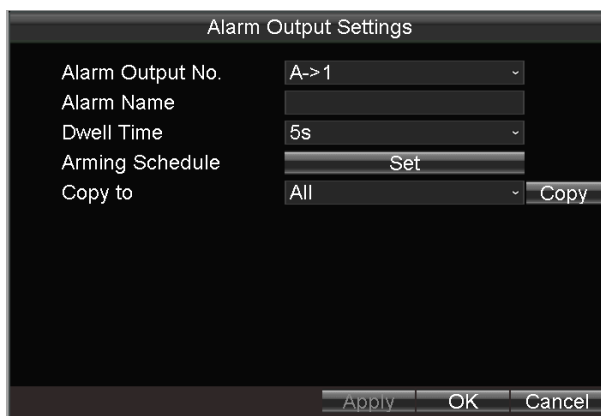

Figure 11. 6 Alarm Output Settings

2. Select the **Alarm Output No.**, input the **Alarm Name** as desired in the text field, and then set the alarm **Dwell Time**.



Two alarm outputs are available: A1 & B1 & C1 and A2 & B2 & C2.

3. Click the **Set** button of **Arming Schedule** to set the arming schedule for alarm outputs. Up to 8 time periods can be set within each day. Optionally, you can click **Copy** to copy the current settings to other days in the week.

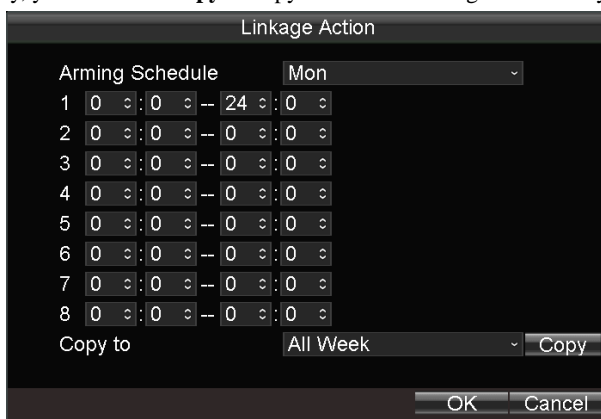

Figure 11. 7 Arming Schedule Settings

4. Click **Apply** to save the new settings and click **OK** to exit.

11.2.3 Configuring Video-Tampering Alarm

Purpose:

A tampering alarm is triggered when the camera is covered and the monitoring area cannot be viewed. Linkage actions including audible warning, alarm output, etc., can be set to handle it.

Steps:

1. Enter the Advanced Camera Settings interface.

Menu > Other Settings > Camera > Set (More Setting)

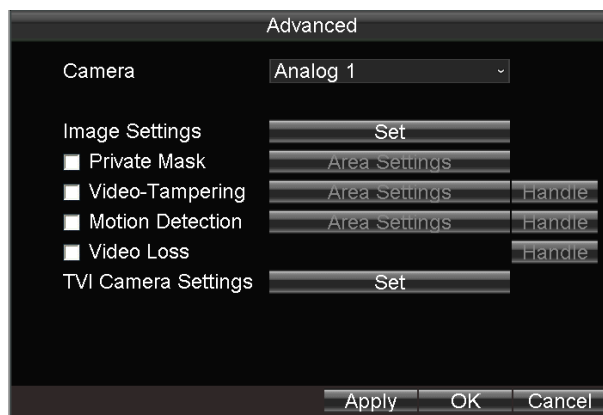

Figure 11. 8 Tamper-Proof Settings

2. Check the checkbox of **Video-Tampering** to enable the video-tampering detection function.
3. Click the **Area Settings** button to set the area for video tampering detection.



The video tampering alarm can be triggered only when the view of the camera is fully covered. The regional video tampering alarm function is reserved.

Perform the following steps to set a specified area for video tampering detection:

- 1) Press the **Edit** key on the remote control and a red block appears on the screen.
 - 2) Press the **Direction** keys on the remote control to adjust the position of the red block.
 - 3) Press the **Enter** key on the remote control to save the position of the red block.
 - 4) Press the **Direction** keys on the remote control to adjust the size of the block.
 - 5) Press the **Enter** key on the remote control to save the size of the block.
 - 6) Press the **Menu** key on the remote control to set the detection sensitivity. You can set the level as Low, Medium or High. Click **OK** to save the settings.
 - 7) You can press the **A** key on the remote control to clear all the mask areas.
 - 8) Press the **Enter** key on the remote control to save the settings and then press **Esc** key to exit.
4. Click the **Handle** button of Tamper-proof, and you can set the **Arming Schedule** and alarm **Linkage Actions** for video tampering alarm.

Perform the following steps to set the arming schedule and alarm triggered linkage actions:

- 1) Select the day from the drop-down list, and set the arming schedule for the alarm linkage actions.
- 2) Optionally, you can copy the current settings to other days in the week.
- 3) Check the checkboxes to enable the corresponding linkage actions.
 - **Full Screen Monitoring**
When an alarm is triggered, the local monitor displays the video image of the current camera.
 - **Audible Warning:**
The device sends out a continuous *beep* when an alarm input is detected.
 - **Trigger Alarm Output:**
Trigger an alarm output when an alarm is detected.
- 4) Click **Apply** to save the new settings and click **OK** to exit.

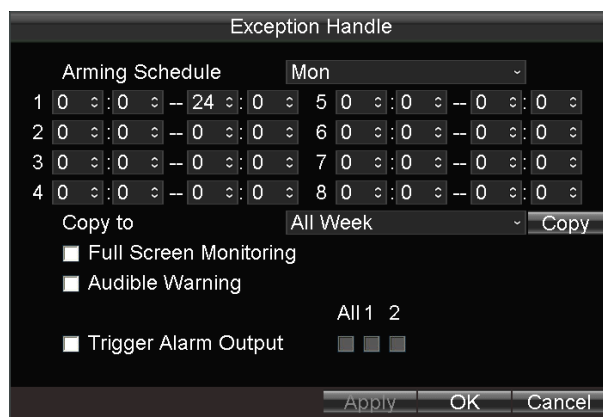

Figure 11. 9 Linkage Action of Tamper-proof

5. Click **Apply** to save the new settings and click **OK** to exit.

11.2.4 Configuring Video Loss Alarm

Purpose:

When the device cannot receive video signal from the front-end devices, the video loss alarm will be triggered. Linkage actions including audible warning, alarm output, etc., can be set to handle it.

Steps:

1. Enter the Advanced Camera Settings interface.
Menu > Other Settings> Camera > Set (More Setting)

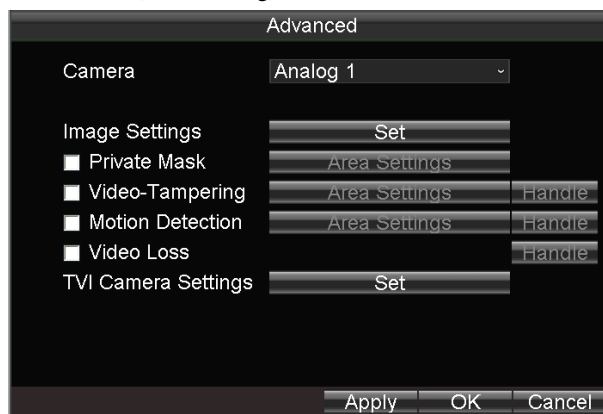

Figure 11. 10 Video Loss Settings

2. Check the checkbox of **Video Loss** to enable the video loss detection settings.
3. Click the **Handle** button of Video Loss Detection, and you can set the **Arming Schedule** and alarm linkage actions for video loss alarm. For details of arming schedule settings and linkage action settings, see step 4 in *11.2.3 Configuring Video-Tampering Alarm*.

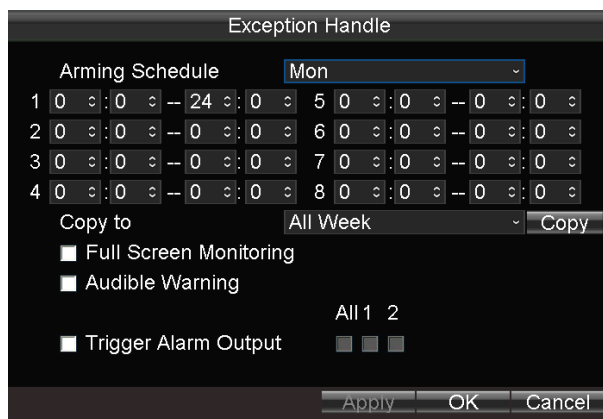

Figure 11. 11 Linkage Action of Video Loss

4. Click **Apply** to save the new settings and click **OK** to exit.

11.2.5 Handling Exceptions

Purpose:

Exception Settings refer to the handling methods of various exceptions, e.g.

- **HDD Full:** The HDD is full.
- **HDD Error:** Writing HDD error, unformatted HDD, etc.
- **Network Disconnected:** Network cable is disconnected.
- **IP Conflicted:** Duplicated IP address.
- **Illegal Login:** Incorrect user id or password.
- **Video Exception:** frame rate is too low.
- **Video Input/Output Standard Mismatch:** I/O video standards do not match.
- **Abnormal Recording:** No space for saving recorded files.

Steps:

1. Enter the Exception interface.
Menu > Other Settings > Exception



Figure 11. 12 Exception

2. Select the **Exception Type** and set the alarm linkage actions, including **Audible Warning** and **Alarm Output**.
3. Click **Apply** to save the new settings and click **OK** to exit.

11.2.6 Configuring Alarm Terminal

Steps:

1. Enter the Alarm Terminal interface.

Menu > Other Settings > Alarm Terminal



Figure 11. 13 Alarm Terminal

2. Check the checkbox of **Enable Alarm Terminal** to enable the alarm terminal settings.
3. Edit the **Terminal Name** if needed.
4. Select the **Trigger Alarm Output**.
5. Select the alarm **Trigger Record Channel**. When the connected alarm terminal triggers alarm, and the selected Trigger Record Channel enables normal recording, then a manual alarm event will be recorded.
6. Click **Apply** to save the new settings and click **OK** to exit.



- The alarm terminal function requires for the cooperation of status display terminal DS-1530HMI. For details, see the user manual of DS-1530HMI.
- The RS-232 serial port should be used in the way of transparent channel and the baud rate should be set as 9600.

11.3 Firewall Settings

Purpose:

The mobile DVR provides software-based firewall to protect the device against the threats from the public network. A white list can be set, and only the trusted IP addresses on the white list can access the device via the network.



- The IP address of the platform server to add the device is set as the trusted IP address.
- Up to 16 IP addresses can be added on the white list.

Steps:

1. Enter the Firewall Settings interface.

Menu > Other Settings > Firewall



Figure 11. 14 Firewall Settings

2. Optionally, you can select **Enable SSH Service**, thus to effectively prevent information leakage during remote management.
3. Click the **Add** button to enter the Add IP Address dialog box, input the trusted IP address, and click **OK**.

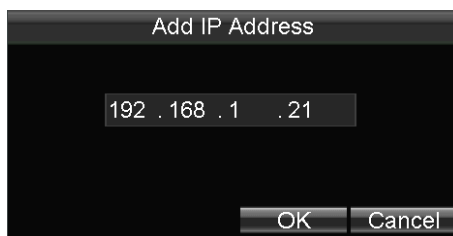

Figure 11. 15 Add IP Address

4. The trusted IP address will be added on the white list.



Figure 11. 16 White List Settings



The configured white list will be cleared after you reboot the device.

5. To delete the trusted IP address, you can select it on the white list and then click the **Delete** button. You can also click the **Clean All** button to clear all the trusted IP address on the white list.

11.4 Serial Port Settings

Purpose:

Two types of serial ports are provided: RS-232 and RS-485.

The RS-232 port can be used in two ways:

- **Console:** Connect a PC to the DVR through the PC serial port. DVR parameters can be configured by using software such as HyperTerminal. The serial port parameters must be the same as of the device when connecting with the PC serial port.
- **Transparent Channel:** Connect a serial device directly to the device. The serial device will be controlled remotely by the PC through the network and the protocol of the serial device.

The RS-485 port can be used for transparent channel only.

Steps:

1. Enter the Serial Port Settings interface to configure the parameters.

Menu > Basic Settings > Serial Port

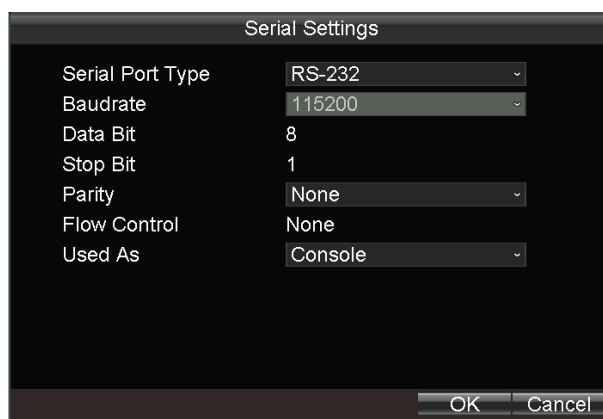

Figure 11. 17 Serial Port Settings Interface

2. Select **Serial Port Type** and configure the parameters, including baudrate, parity, and usage.
3. If a **Serial Port Box** is connected to the device, click **Set** to configure the serial port box parameters.



Figure 11. 18 SPBOX Set

4. Select the **Serial Port Type** in the dropdown list and configure other parameters, including baud rate, parity and usage.
5. Click **OK** to save the settings and go back to upper menu.
6. Click **OK** to save the settings.

Chapter 12 Device Maintenance

12.1 Checking Status

The status of recording, dialing, platform, satellite positioning, G-Sensor, alarm, and WiFi can be checked in the Status interface (Menu > Status).

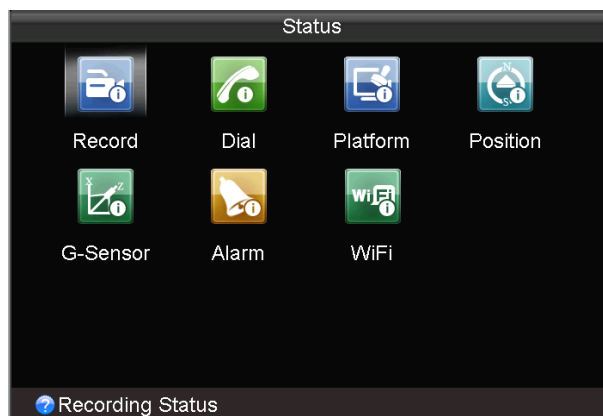

Figure 12. 1 Status Interface

12.2 Management and Maintenance

12.2.1 Upgrading the System

Purpose:

The mobile DVR can be upgraded by local USB device or remote FTP server.

➤ **Upgrading by local USB flash disk**

Before you start:

Connect the USB device, on which the upgrade firmware is stored, to the mobile DVR.



The upgrade firmware should be stored in the root directory of the USB device.

Steps:

1. Enter the Upgrade interface and select USB Upgrade as the upgrade type.
Menu > Maintenance > Upgrade

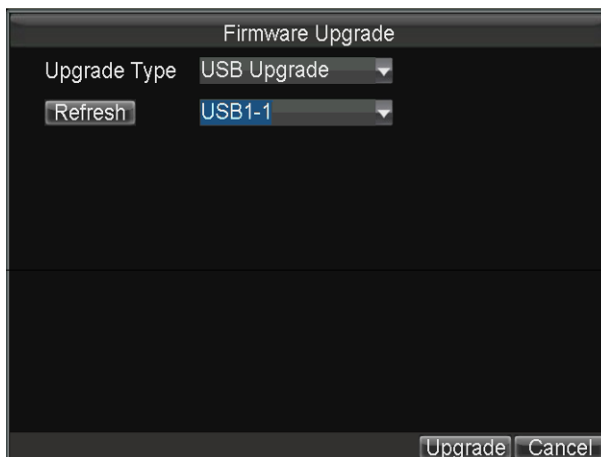

Figure 12. 2 Upgrade Interface

2. Click **Refresh** to refresh the latest information of the connected USB device.
3. Click **Upgrade** to start upgrading and reboot the device to activate the new settings.

➤ **Upgrading by remote FTP server**

Before you start:

Ensure the network connection of the PC (running FTP server) and the DVR is valid and correct. Run the FTP server on the PC and copy the firmware into the corresponding directory of your PC.



Refer to the user manual of the FTP server to set the FTP server on your PC and put the firmware file into the directory as required.

Steps:

1. Enter the Upgrade interface and select **FTP Upgrade** as the upgrade type.

Menu > Maintenance > Upgrade

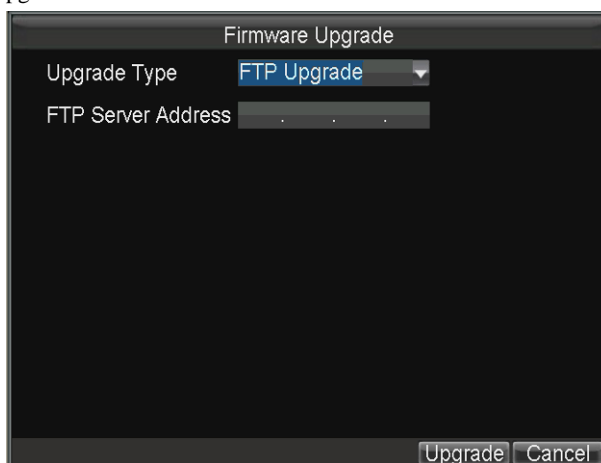

Figure 12. 3 Upgrade Interface

2. Enter the **FTP Server Address** in the text field.
3. Click **Upgrade** to start upgrading and reboot the device to activate the new settings.

12.2.2 Searching & Exporting Log files

Purpose:

The operation, alarm, exception and information of the device can be stored in log files, which can be viewed and exported at any time.

Steps:

1. Enter the Log Search interface.

Menu > Maintenance > Log Search

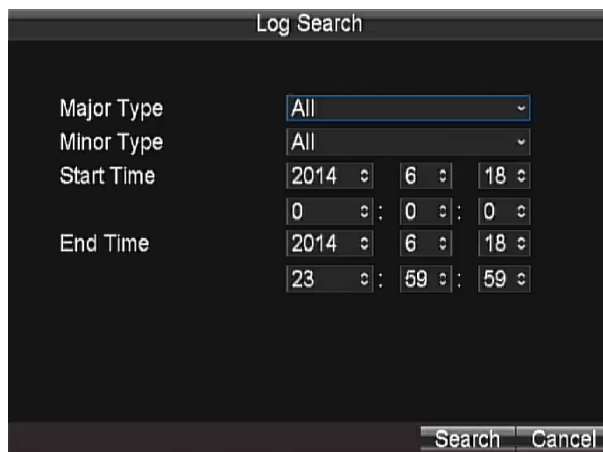

Figure 12. 4 Log Search Interface

2. Select the **Major Type** of the logs from the drop-down list, including **Alarm, Exception, Operation, and Information**. You can also select **All** as the Major Type to search all the logs.
3. Select the **Minor Type** of the logs under the selected major type.
4. Specify the **Start Time** and **End Time** for the log search.



- Press **Left/Right** keys on the remote control to positioning the cursor.
 - Press **Up/Down** keys on the remote control to adjust the date and time.
5. Click the **Search** button. The logs matching the search conditions will be displayed on a list.

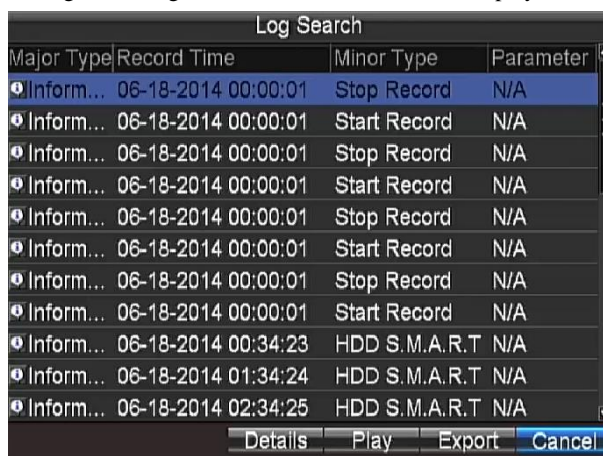

Figure 12. 5 Log Search Results

6. Select the log item, and then click **Details** to view the detailed information of the selected log.

Select the log item, and then click **Play** to play the related record files (If there is any record file related).
 Connect the USB device to the mobile DVR, and then click **Export** to export the log file to the USB device for backup.



- Press **Up/Down** keys on the remote control to positioning the cursor on the list.
- Press **Left/Right** keys on the remote control to select the **Play**, **Export** or **Cancel** buttons.
- Press **Enter** key on the remote control to select the log file.

12.2.3 Restoring Default Settings

Steps:

1. Enter the Default interface.
 Menu > Maintenance > Default

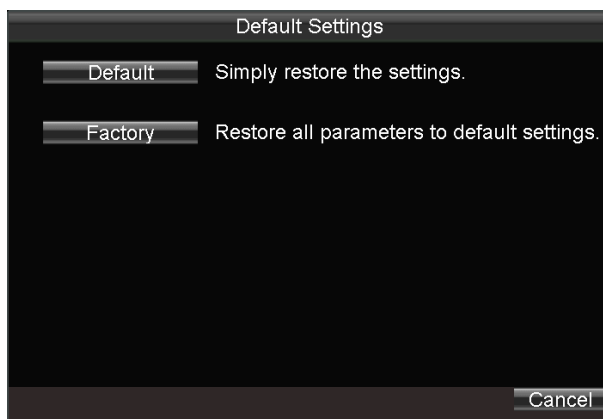

Figure 12. 6 Restore Default Settings

2. Select the restoring type from the following two options.
 - **Default:** Restore all parameters, except the network (including IP address, subnet mask, gateway, MTU, NIC working mode, default route, server port, etc.) and user account parameters, to the factory default settings.
 - **Factory:** Restore all parameters to the factory default settings.
3. Click the **OK** button to start restoring default settings.

12.2.4 Importing/Exporting Configuration Files

Purpose:

The configuration files of the mobile DVR can be exported to local device for backup; and the configuration files of one device can be imported to multiple devices if they are to be configured with the same parameters.

Before you start:

Connect a USB device to the mobile DVR.

Steps:

1. Enter the Import/Export Configuration Files interface.
 Menu > Maintenance > Configuration

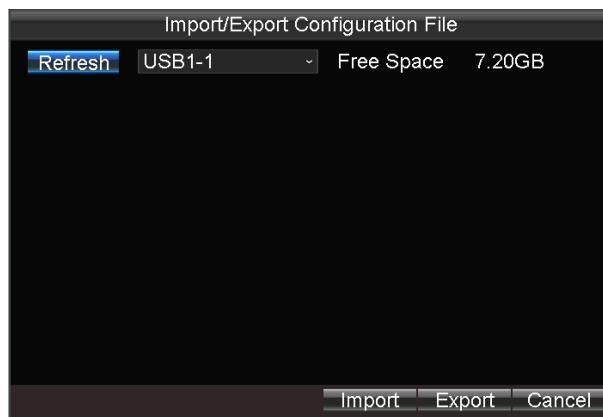

Figure 12. 7 Import/Export Configuration Files

2. Click the **Export** button to export configuration files to the USB device.
3. To import the configuration file, connect a USB device on which the configuration file is stored to the mobile DVR, and then click the **Import** button. Reboot the device to activate the new settings after the importing process is complete.



The configuration file should be stored on the root directory of the USB device.

12.2.5 Viewing System Information

Steps:

1. Enter the System Information interface.

Menu>Maintenance>Information

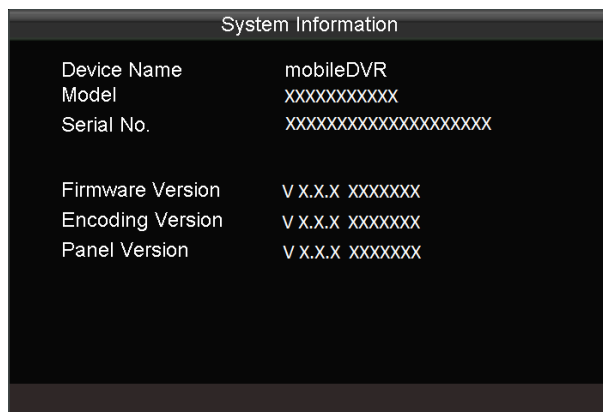

Figure 12. 8 System Information

2. You can view the device name, model, serial No. , firmware version, encoding version and panel version.

12.2.6 Backup Device

Purpose:

You can view the status and the free space/capacity of the connected USB backup device. And you can also format the

backup device if needed.

Steps:

1. Enter the Backup Device interface.

Menu > Maintenance > Storage



Figure 12. 9 Backup Device Interface

2. Select the backup device from the drop-down list. You can view the status and the free space/capacity of the backup device.
3. Click **Format**, and you can format the selected USB backup device.

12.2.7 Rebooting DVR

You can go to the Reboot interface (Menu > Maintenance > Reboot) to reboot the DVR.

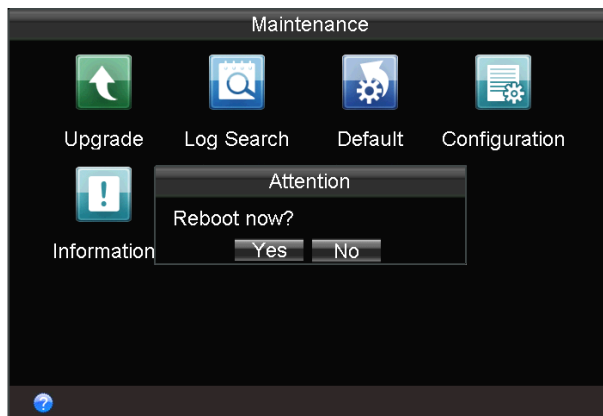

Figure 12. 10 Reboot Interface

Chapter 13 Appendix

13.1 Glossary

- **3G/4G:** 3G/4G refers to the 3rd/4th-generation telecommunication technology which is the high speed transmission of the cell data. The 3G/4G service can transmit sound and other data simultaneously and the bitrate is up to hundreds kbps.
- **DHCP:** DHCP is the acronym of Dynamic Host Configuration Protocol, and it is one of the TCP/IP protocol stacks, it is used to assign the dynamic IP address to the host on the network.
- **Dual Stream:** Dual stream is a technology used to record high resolution video locally while transmitting a lower resolution stream over the network.
- **GNSS:** A satellite navigation system is a system of satellites that provide autonomous geo-spatial positioning with global coverage. It allows small electronic receivers to determine their location (longitude, latitude, and altitude) to high precision (within a few meters) using time signals transmitted along a line of sight by radio from satellites. The signals also allow the electronic receivers to calculate the current local time to high precision, which allows time synchronization. A satellite navigation system with global coverage may be termed GNSS (Global Navigation Satellite System).
- **GPS:** GPS (Global Positioning System) is a space-based global navigation satellite system that provides location and time information in all weather and anywhere on or near the earth, where there is an unobstructed line of sight to 4 or more GPS satellite.
- **G-Sensor:** G-sensor (Gravity-sensor) can sense the change of the accelerated force, such as the shaking, free falling and lifting. And those changes of the accelerated force can be sensed by the G-sensor in a means of electrical signals, and then link certain action according to the changes of the electrical signals. When applied in the hard disk protection, G-Sensor can check the current status of the hard disk in case of the affection of the R/W function by the sudden change of the accelerated force.
- **NTP:** NTP is Network Time Protocol, and it is a protocol used to synchronize the computer time.
- **Sensor-In:** Sensor-In is a built-in module on the mobile DVR used to record the movement information of the vehicle, such as the braking, left-turning and right0turning and so on. The information can be used for analysis of an accident.
- **Transparent Channel:** Transparent channel is a mechanism which analyzes the IP datagram and sends it by the serial interface. It extends the control distance of the serial devices and for the user, only the point to point transmission is seen and the actual transmission is ignored.
- **VPDN:** Virtual Private Dial-up Network is a network that uses primarily public telecommunication infrastructure, such as the internet, to provide remote office or travelling users' access to a central organization network, such as the ISP private network, financial network and so on.
- **Wi-Fi:** Wi-Fi is a mechanism of the wireless connecting electronic devices. A device enabled with Wi-Fi such as PC, video game console, can connect to the internet via a wireless network access point.

13.2 FAQ

- **Why does my DVR make a beeping sound after booting?**

The possible reasons for the warning beep on the device are as follows:

- a) There is no hard disk installed in the device.
- b) The hard disk is not initialized.
- c) Hard disk error

To cancel the beeping sound and use the device without any hard disks, enter the Exception Settings interface. For detailed information, see *11.2.5 Handling Exceptions*.

- **DVR fails to start up after connecting the power.**

Possible reasons:

- a) Incorrect voltage input (9 to 32 VDC) and power consumption ($\geq 50W$).
- b) The power connections are incorrect and please refer to *1.2 Rear Panel*.
- c) The motherboard or power functions abnormally. In case of hardware failure, please contact the supplier of the product.

- **Fail to connect 3G/4G.**

Possible reasons for 3G/4G connection failure are as follows:

- a) Dialing is not enabled.
- b) APN, dial number, user name and password should be set for 3G/4G VPDN private network.
- c) No 3G/4G antenna connected. When both the master/slave antennas are connected, locate them vertically with above 20cm distance from each other.
- d) SIM card is out of service or 3G/4G service is not opened.

- **Fail to connect to Wi-Fi.**

Please check the following settings:

- a) The SSID, encryption type or password are entered incorrectly.
- b) AP (access point) or router works abnormally.
- c) No Wi-Fi antenna connected or the antenna is not vertically located.

- **The DVR cannot be accessed via platform (iVMS) after successful connection to 3G/4G or Wi-Fi.**

Possible reasons:

- a) The parameters (e.g., server IP, device registered ID, etc.) of the platform are configured incorrectly.
- b) The platform works abnormally.

- **Fail to obtain satellite positioning information.**

Possible reasons:

- a) The satellite positioning antenna is not placed outdoor.
- b) There is no satellite positioning module (built-in or external) available for the DVR.
- c) The Position Module are configured incorrectly (please see *10.2 Configuring Satellite Positioning*).

- **Why does the device seem unresponsive when operating with the IR remote control?**

Please read *1.3 IR Remote Control Introduction*

The mobile DVR can be controlled via IR remote control and mouse.

, and check:

- a) The batteries are installed correctly, making sure that the polarities of the batteries are not reversed.
- b) The batteries are fresh and are not out of power.
- c) The remote sensor is not covered or blocked by other object.
- d) There are no fluorescent lamps in use nearby.

- **No backup device is detected when exporting recorded files?**

Possible reasons:

- a) There is no backup device connected with the DVR.
- b) The DVR and your backup device are not compatible.
- c) Initialize the backup device before using.
- d) The backup device is damaged.



First Choice for Security Professionals