



Network Traffic Camera (for Smart Monitoring)

User Manual

©2020 Hangzhou Hikvision Digital Technology Co., Ltd. All rights reserved.

About this Manual

The Manual includes instructions for using and managing the Product. Pictures, charts, images and all other information hereinafter are for description and explanation only. The information contained in the Manual is subject to change, without notice, due to firmware updates or other reasons. Please find the latest version of this Manual at the Hikvision website (<https://www.hikvision.com/>).

Please use this Manual with the guidance and assistance of professionals trained in supporting the Product.

Trademarks

HIKVISION and other Hikvision's trademarks and logos are the properties of Hikvision in various jurisdictions.

Other trademarks and logos mentioned are the properties of their respective owners.

Disclaimer

TO THE MAXIMUM EXTENT PERMITTED BY APPLICABLE LAW, THIS MANUAL AND THE PRODUCT DESCRIBED, WITH ITS HARDWARE, SOFTWARE AND FIRMWARE, ARE PROVIDED "AS IS" AND "WITH ALL FAULTS AND ERRORS". HIKVISION MAKES NO WARRANTIES, EXPRESS OR IMPLIED, INCLUDING WITHOUT LIMITATION, MERCHANTABILITY, SATISFACTORY QUALITY, OR FITNESS FOR A PARTICULAR PURPOSE. THE USE OF THE PRODUCT BY YOU IS AT YOUR OWN RISK. IN NO EVENT WILL HIKVISION BE LIABLE TO YOU FOR ANY SPECIAL, CONSEQUENTIAL, INCIDENTAL, OR INDIRECT DAMAGES, INCLUDING, AMONG OTHERS, DAMAGES FOR LOSS OF BUSINESS PROFITS, BUSINESS INTERRUPTION, OR LOSS OF DATA, CORRUPTION OF SYSTEMS, OR LOSS OF DOCUMENTATION, WHETHER BASED ON BREACH OF CONTRACT, TORT (INCLUDING NEGLIGENCE), PRODUCT LIABILITY, OR OTHERWISE, IN CONNECTION WITH THE USE OF THE PRODUCT, EVEN IF HIKVISION HAS BEEN ADVISED OF THE POSSIBILITY OF SUCH DAMAGES OR LOSS.

YOU ACKNOWLEDGE THAT THE NATURE OF THE INTERNET PROVIDES FOR INHERENT SECURITY RISKS, AND HIKVISION SHALL NOT TAKE ANY RESPONSIBILITIES FOR ABNORMAL OPERATION, PRIVACY LEAKAGE OR OTHER DAMAGES RESULTING FROM CYBER-ATTACK, HACKER ATTACK, VIRUS INFECTION, OR OTHER INTERNET SECURITY RISKS; HOWEVER, HIKVISION WILL PROVIDE TIMELY TECHNICAL SUPPORT IF REQUIRED.

YOU AGREE TO USE THIS PRODUCT IN COMPLIANCE WITH ALL APPLICABLE LAWS, AND YOU ARE SOLELY RESPONSIBLE FOR ENSURING THAT YOUR USE CONFORMS TO THE APPLICABLE LAW. ESPECIALLY, YOU ARE RESPONSIBLE, FOR USING THIS PRODUCT IN A MANNER THAT DOES NOT INFRINGE ON THE RIGHTS OF THIRD PARTIES, INCLUDING WITHOUT LIMITATION, RIGHTS OF PUBLICITY, INTELLECTUAL PROPERTY RIGHTS, OR DATA PROTECTION AND OTHER PRIVACY RIGHTS. YOU SHALL NOT USE THIS PRODUCT FOR ANY PROHIBITED END-USES, INCLUDING THE DEVELOPMENT OR PRODUCTION OF WEAPONS OF MASS DESTRUCTION, THE DEVELOPMENT OR PRODUCTION OF CHEMICAL OR BIOLOGICAL WEAPONS, ANY ACTIVITIES IN THE CONTEXT RELATED TO ANY NUCLEAR EXPLOSIVE OR UNSAFE NUCLEAR FUEL-CYCLE, OR IN SUPPORT OF HUMAN RIGHTS ABUSES.

IN THE EVENT OF ANY CONFLICTS BETWEEN THIS MANUAL AND THE APPLICABLE LAW, THE LATER PREVAILS.

Regulatory Information

FCC Information

Please take attention that changes or modification not expressly approved by the party responsible for compliance could void the user's authority to operate the equipment.

FCC compliance: This equipment has been tested and found to comply with the limits for a Class A digital device, pursuant to part 15 of the FCC Rules. These limits are designed to provide reasonable protection against harmful interference when the equipment is operated in a commercial environment. This equipment generates, uses, and can radiate radio frequency energy and, if not installed and used in accordance with the instruction manual, may cause harmful interference to radio communications. Operation of this equipment in a residential area is likely to cause harmful interference in which case the user will be required to correct the interference at his own expense.

FCC Conditions

This device complies with part 15 of the FCC Rules. Operation is subject to the following two conditions:

1. This device may not cause harmful interference.
2. This device must accept any interference received, including interference that may cause undesired operation.

EU Conformity Statement

 This product and - if applicable - the supplied accessories too are marked with "CE" and comply therefore with the applicable harmonized European standards listed under the EMC Directive 2014/30/EU, the LVD Directive 2014/35/EU, the RoHS Directive 2011/65/EU.

 2012/19/EU (WEEE directive): Products marked with this symbol cannot be disposed of as unsorted municipal waste in the European Union. For proper recycling, return this product to your local supplier upon the purchase of equivalent new equipment, or dispose of it at designated collection points. For more information see: www.recyclethis.info



 2006/66/EC (battery directive): This product contains a battery that cannot be disposed of as unsorted municipal waste in the European Union. See the product documentation for specific battery information. The battery is marked with this symbol, which may include lettering to indicate cadmium (Cd), lead (Pb), or mercury (Hg). For proper recycling, return the battery to your supplier or to a designated collection point. For more information see: www.recyclethis.info

Industry Canada ICES-003 Compliance

This device meets the CAN ICES-3 (A)/NMB-3(A) standards requirements.

Symbol Conventions

The symbols that may be found in this document are defined as follows.

Symbol	Description
 NOTE	Provides additional information to emphasize or supplement important points of the main text.
 WARNING	Indicates a potentially hazardous situation, which if not avoided, could result in equipment damage, data loss, performance degradation, or unexpected results.
 DANGER	Indicates a hazard with a high level of risk, which if not avoided, will result in death or serious injury.

Safety Instructions

Laws and Regulations	Use of the product must be in strict compliance with the local laws and regulations. Please shut down the device in prohibited area.
Power Supply	<ul style="list-style-type: none"> ● Use of the product must be in strict compliance with the local electrical safety regulations. ● Use the power adapter provided by qualified manufacturer. Refer to the product specification for detailed power requirements. ● It is recommended to provide independent power adapter for each device as adapter overload may cause over-heating or a fire hazard. ● Make sure that the power has been disconnected before you wire, install, or disassemble the device. ● DO NOT directly touch exposed contacts and components once the device is powered up to avoid electric shock. ● DO NOT use damaged power supply devices (e.g., cable, power adapter, etc.) to avoid electric shock, fire hazard, and explosion. ● DO NOT directly cut the power supply to shut down the device. Please shut down the device normally and then unplug the power cord to avoid data loss. ● DO NOT block the power supply equipment to plug and unplug conveniently. ● Make sure the power supply has been disconnected if the power adapter is idle. ● Make sure the device is connected to the ground firmly.

<p>Transportation, Use, and Storage</p>	<ul style="list-style-type: none"> ● To avoid heat accumulation, good ventilation is required for a proper operating environment. ● Store the device in dry, well-ventilated, corrosive-gas-free, no direct sunlight, and no heating source environment. ● Avoid fire, water, and explosive environment when using the device. ● Avoid lightning strike for device installation. Install a lightning arrester if necessary. ● Keep the device away from magnetic interference. ● Avoid device installation on vibratory surface or places, and avoid equipment installation on vibratory surface or places subject to shock (ignorance may cause device damage). ● DO NOT touch the heat dissipation component to avoid burns. ● DO NOT contact the device shell immediately. If necessary, contact it 30 minutes later after cutting off the power. ● The device is only suitable for installation in the area above 2m to use. ● DO NOT expose the device to extremely hot, cold, or humidity environments. For temperature and humidity requirements, see device specification.
<p>Maintenance</p>	<ul style="list-style-type: none"> ● If smoke, odor, or noise arises from the device, immediately turn off the power, unplug the power cable, and contact the service center. ● If the device is abnormal, contact the store you purchased it or the nearest service center. DO NOT disassemble or modify the device in any way (For the problems caused by unauthorized modification or maintenance, the company shall not take any responsibility). ● Keep all wrappers after unpacking them for future use. In case of any failure occurred, you need to return the device to the factory with the original wrapper. Transportation without the original wrapper may result in damage to the device and the company shall not take any responsibility.
<p>Network</p>	<ul style="list-style-type: none"> ● Please enforce the protection for the personal information and the data security as the device may be confronted with the network security problems when it is connected to the Internet. Please contact us when the device might exist network security risks. ● Please understand that you have the responsibility to configure all the passwords and other security settings about the device, and keep your user name and password.
<p>Data</p>	<p>DO NOT disconnect the power during formatting, uploading, and downloading. Or files may be damaged.</p>

TABLE OF CONTENTS

Chapter 1 Network Connection	7
1.1 Wiring over the LAN	7
1.2 Activate the Camera	8
1.2.1 Activation via Web Browser	8
1.2.2 Activation via SADP Software	9
Chapter 2 Login.....	11
Chapter 3 Live View	12
3.1 Live View Page	12
3.2 Start Live View	13
3.3 Record and Capture Pictures Manually	14
3.4 View Live Traffic Statistics	14
3.4.1 Scene Shot Area	14
3.4.2 Traffic Statistics	16
Chapter 4 Picture Search	17
Chapter 5 Local Configuration	18
Chapter 6 System Configuration	20
6.1 View Device Information	20
6.2 Set Installation Parameters	20
6.3 Set Serial Ports	21
6.4 Set Network Parameters	21
6.5 Set Port	23
6.6 Set HTTPS	24
6.7 Set Time	25
6.8 Set Service	27
6.9 Set EHome Protocol	28
6.10 Set Wiegand Parameters.....	28
Chapter 7 Encoding and Storage Configuration	30
7.1 Set Video Encoding	30
7.2 Set Image Encoding	32
7.3 Set ROI	32
7.4 Set Record Schedule	33
7.5 Set Storage Management	35
7.6 Set FTP	36
7.7 Set Cloud Storage	38
7.8 Set Upload Protocol	39
Chapter 8 Text Overlay Configuration.....	41
8.1 Set Capture Overlay	41
8.2 Set OSD Settings	43
Chapter 9 Capture Parameters Configuration	45
9.1 Set License Plate Parameters	45
9.2 Set Flash Light Parameters	45

9.3 Set Vehicle Feature	46
Chapter 10 Image Parameters Configuration.....	48
10.1 Set General Parameters	48
10.2 Set Video	49
10.3 Set Picture	51
10.4 Set ICR.....	51
Chapter 11 Entrances and Exits Configuration.....	53
11.1 Set White-Black List	53
11.2 Set Entrance and Exit	56
Chapter 12 Application Mode Configuration	59
12.1 Smart Mode	59
12.2 License Plate Recognition System	60
Chapter 13 Exception.....	64
Chapter 14 Maintenance	65
14.1 Device Status	65
14.2 User Management.....	65
14.2.1 Add a User	66
14.2.2 Modify a User	67
14.2.3 Delete a User	68
14.3 Log Search	68
14.4 Reboot the Camera.....	68
14.5 Restore Default Settings.....	69
14.6 Export Debug File	69
14.7 Export Configuration File	69
14.8 Import Configuration File.....	70
14.9 Upgrade the System.....	70

Chapter 1 Network Connection

NOTE

- You shall acknowledge that the use of the product with Internet access might be under network security risks. For avoidance of any network attacks and information leakage, please strengthen your own protection. If the product does not work properly, please contact with your dealer or the nearest service center.
- To ensure the network security of the camera, we recommend you to have the camera assessed and maintained termly. You can contact us if you need such service.

Purpose:

To view and configure the camera via a LAN, you need to connect the camera in the same subnet with your computer, and install the SADP to search and change the IP address of the camera.

1.1 Wiring over the LAN

The following figures show the two ways of cable connection of the camera and computer.

Purpose:

- To test the camera, you can directly connect the camera to the computer with a network cable.
- Set camera over the LAN via a switch or a router.

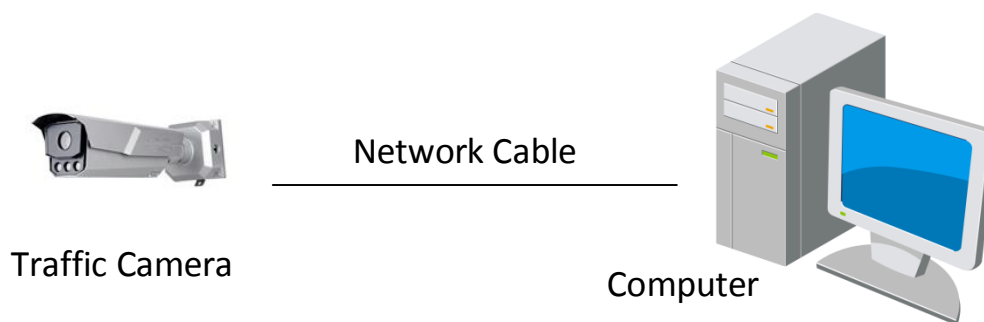

Figure 1-1 Connecting Directly

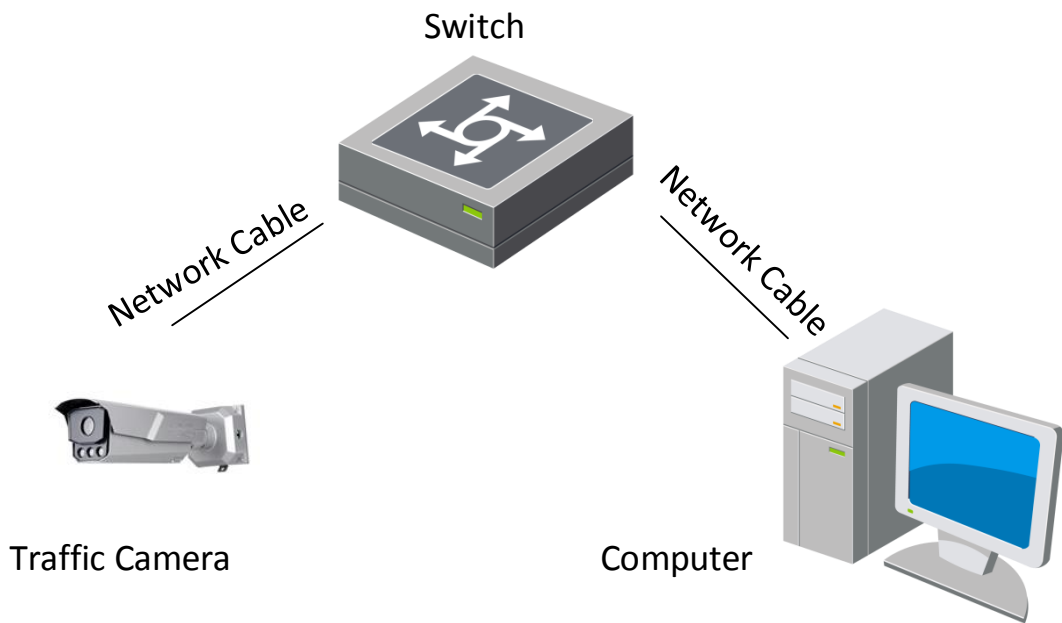

Figure 1-2 Connecting via a Switch or a Router

1.2 Activate the Camera

You are required to activate the camera first by setting a strong password for it before you can use the camera.

Activation via Web Browser and Activation via SADP Software are supported.

1.2.1 Activation via Web Browser

Step 1 Power on the camera, and connect the camera to the network.

Step 2 Input the IP address into the address bar of the web browser, and press Enter to enter the activation interface.

The screenshot shows a web browser window titled 'Activate'. It contains the following fields and text:

- User Name:** admin
- Password:** An empty text input field with a strength indicator below it.
- Confirm Password:** An empty text input field.
- Instructions:** Valid password range [8-16]. You can use a combination of numbers, lowercase, uppercase and special character for your password with at least two kinds of them contained.
- Buttons:** An 'OK' button is located at the bottom right of the form.

Figure 1-3 Activation Interface (Web)

Step 3 Create a password and input the password into the password field.



WARNING

STRONG PASSWORD RECOMMENDED– We highly recommend you create a strong password of your own choosing (using a minimum of 8 characters, including upper case letters, lower case letters, numbers, and special characters) in order to increase the security of your product. And we recommend you reset your password regularly, especially in the high security system, resetting the password monthly or weekly can better protect your product.

Step 4 Confirm the password.

Step 5 Click **OK** to save the password and enter the live view interface.

1.2.2 Activation via SADP Software

SADP software is used for detecting the online device, activating the camera, and resetting the password.

Get the SADP software from the official website, and install the SADP according to the prompts.

Step 1 Run the SADP software to search the online devices.

Step 2 Check the device status from the device list, and select the inactive device.

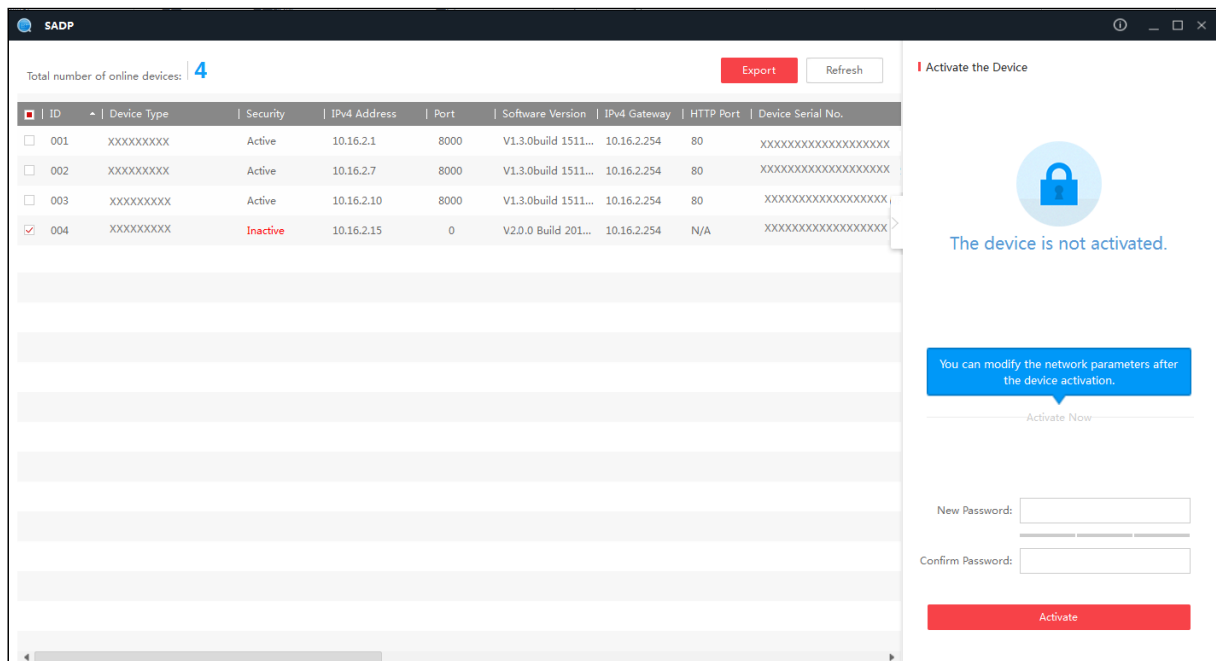

Figure 1-4 SADP Interface

Step 3 Create a password and input the password in the password field, and confirm it.

Step 4 Click **Activate** to activate the device.



WARNING

STRONG PASSWORD RECOMMENDED– We highly recommend you create a strong password of your own choosing (using a minimum of 8 characters, including upper case letters, lower case letters, numbers, and special characters) in order to increase the security of your product. And we recommend you reset your password regularly, especially in the high security system, resetting the password monthly or weekly can better protect your product.

Step 5 Change the device IP address to the same subnet with your computer by either modifying the IP address manually.

Modify Network Parameters

Enable DHCP

Device Serial No.: XXXXXXXXXXXXX

IP Address: 10.16.2.15

Port: 0

Subnet Mask: 255.255.255.0

Gateway: 10.16.2.254

IPv6 Address:

IPv6 Gateway:

IPv6 Prefix Length: 0

HTTP Port: 0

Security Verification

Admin Password: ●●●●●●

Modify

[Forgot Password](#)

Figure 1-5 Create Password

Step 6 Input the password and click **Modify** to activate your IP address modification.

Chapter 2 Login

Step 1 Open the web browser.

Step 2 In the browser address bar, input the IP address of the camera, and press the **Enter** key to enter the login interface.

Step 3 Input **User Name** and **Password**.

Step 4 Click **Login**.

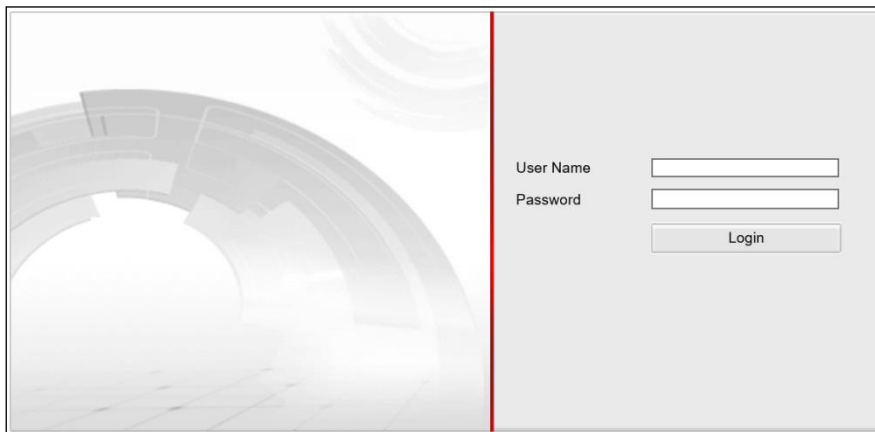

Figure 2-1 Login

Step 5 Install the plug-in before viewing the live video and operating the camera. Follow the installation prompts to install the plug-in.

 **NOTE**

You may have to close the web browser to install the plug-in. Please reopen the web browser and log in again after installing the plug-in.

Chapter 3 Live View

3.1 Live View Page

Purpose:

The live view page allows you to view the real-time video and capture images.

Log in the camera to enter the live view page, or you can click **Live View** on the menu bar of the main page to enter the live view page.

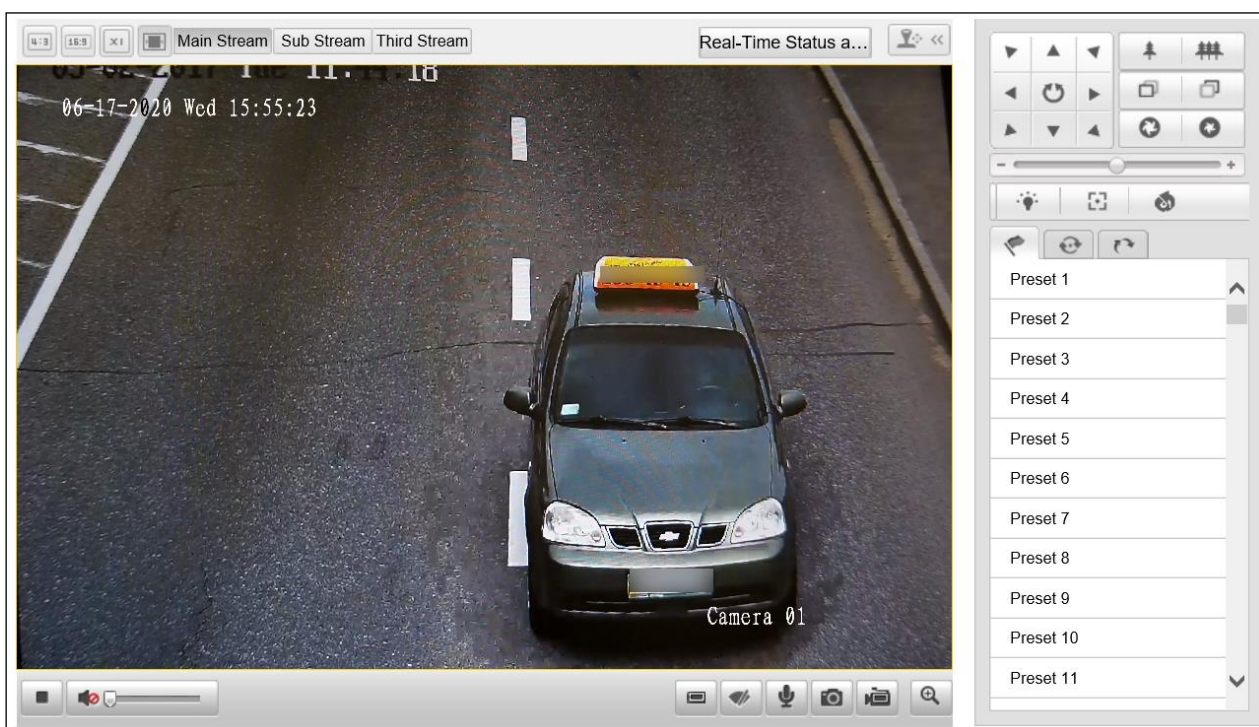























Figure 3-1 Live View Page

Refer to the following table for the description of the icons on the live view page.



Table 3-1 Descriptions of Live View Icons

Icon	Description
	Start/Stop live view.
	The window size is 4:3.
	The window size is 16:9.
	The original window size.
	Self-adaptive window size.
Main Stream	Live view with the main stream. If the network is in good condition, select main stream.
Sub Stream	Live view with the sub stream.
Third Stream	Live view with the third stream.
	Start/Stop audio and adjust the volume.
	Enable regional focus.
	Wiper.
	Enable/Disable two-way audio.
	Manually capture the picture.
	Manually start/stop recording.
	Turn on/off digital zoom function.
Live Traffic Statistics	Enter the Live Traffic Statistics page.
	Zoom out/in. Click  , the lens zooms in. Click  , the lens zooms out.
	Focus near/far. Click  , the lens focus far and the items far away gets clear. Click  , the lens focus near and the items nearby gets clear.
	When the image is too dark, click  to open the iris. When the image is too bright, click  to close the iris.

3.2 Start Live View

On the live view page, click “” on the toolbar to start the live view of the camera.

3.3 Record and Capture Pictures Manually

On the live view page, click “” on the toolbar to capture the live pictures or click “” to start recording. The saving paths of the captured pictures and recorded videos can be set on the **Configuration > Local Configuration** page.

 **NOTE**

The captured image will be saved as JPEG file in your computer.

3.4 View Live Traffic Statistics

Click **Real-Time Status and Traffic Flow Statistics** on the upper right of the live view window.

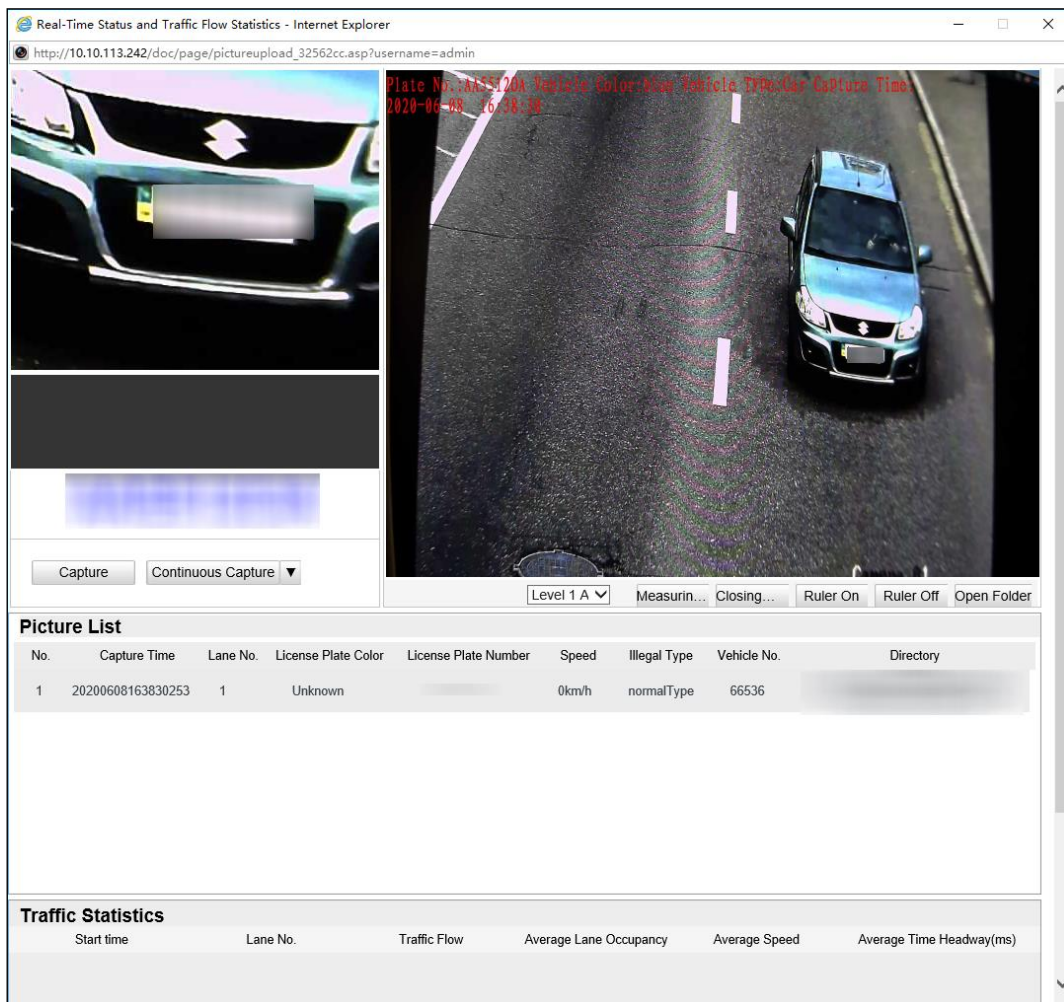

Figure 3-2 Live Traffic Statistics

3.4.1 Scene Shot Area

- Arm the camera.

- **Level 1 Arming:** The camera is allowed to connect to only one data storage device for image, video and information uploading. It is recommended when you develop products, that is, if you use SDK, level 1 arming is the only option.
- **Level 2 Arming:** The camera is allowed to connect to three data storage devices for image and information uploading, such as PC, platform and terminal server.
- **Disarming:** The camera is not allowed to connect to any data storage devices.



Level 2 Arming is recommended for debugging. Because when the device is running, Level 1 Arming cannot be activated.

- **Measuring License Plate:** Measure the pixel of the captured license plate. You can click **Closing Measurement** to disable the function.
- **Ruler On:** Enable ruler to measure the length of the captured license plate. You can click **Ruler Off** to disable the function.
- **Open Folder:** Open the folder that saves the captured pictures.
- **Capture:** Click **Capture** to capture the picture, and the captured pictures will be listed in the Picture List.

Picture List					
No.	Capture Time	Lane No.	License Plate No.	Vehicle No.	Directory

Figure 3-3 Picture List

Table 3-2 Description of Picture List Parameters

Item	Description
No.	Picture No.
Capture Time	The time of capturing the picture with millisecond precision. For example, 20150915111054738 means the picture is captured at 11:10:54:738, on September 15 th , in 2015.
Lane No.	The lane where the vehicle is captured.
License Plate Number	The license plate number of the vehicle.
Vehicle No.	The vehicle counting No. ranging from 1 to 65535. It will overwrite if it reaches the max. value.
Directory	The file path of the saved picture.

- **Continuous Capture:** Click **Continuous Capture** to capture pictures continuously, and click “▼” to set continuous capture parameters including **Lane No.**, **Waiting Time**, **Capture Times**, and **Continuous Capture Interval**.

Figure 3-4 Set Continuous Capture Parameters

- **Lane No.:** The lane where the vehicle is captured.
- **Waiting Time:** Delay time from capture order had been delivered to vehicle to vehicle has been actually captured.
- **Capture Times:** Number of captured pictures.
- **Continuous Capture Interval:** The time interval of the continuous pictures captured.

3.4.2 Traffic Statistics

Purpose:

The traffic statistics allows you to view the real-time traffic flow status.

Before you start:

Step 1 Go to **Configuration > Device Configuration> System Configuration> Traffic Parameters.**

Step 2 Check **Enable**, and set **Traffic Statistics Interval.**

Click **Real-Time Status and Traffic Flow Statistics > Traffic Statistics**, you can view the corresponding information.

Traffic Statistics					
Start time	Lane No.	Traffic Flow	Average Lane Occupancy	Average Speed	Average Time Headway(ms)

Figure 3-5 View Traffic Statistics

Chapter 4 Picture Search

Purpose:

The captured picture of all types, including normal, overspeed, wrong-way driving, etc., can be searched from this page. You can also export the pictures to the PC local directory.

Before you start:

Please insert a TF card with up to 128 GB storage in the camera for picture storage. Picture cannot be searched if there is no TF card.

Step 1 Click **Picture** on the menu bar to enter picture searching page.

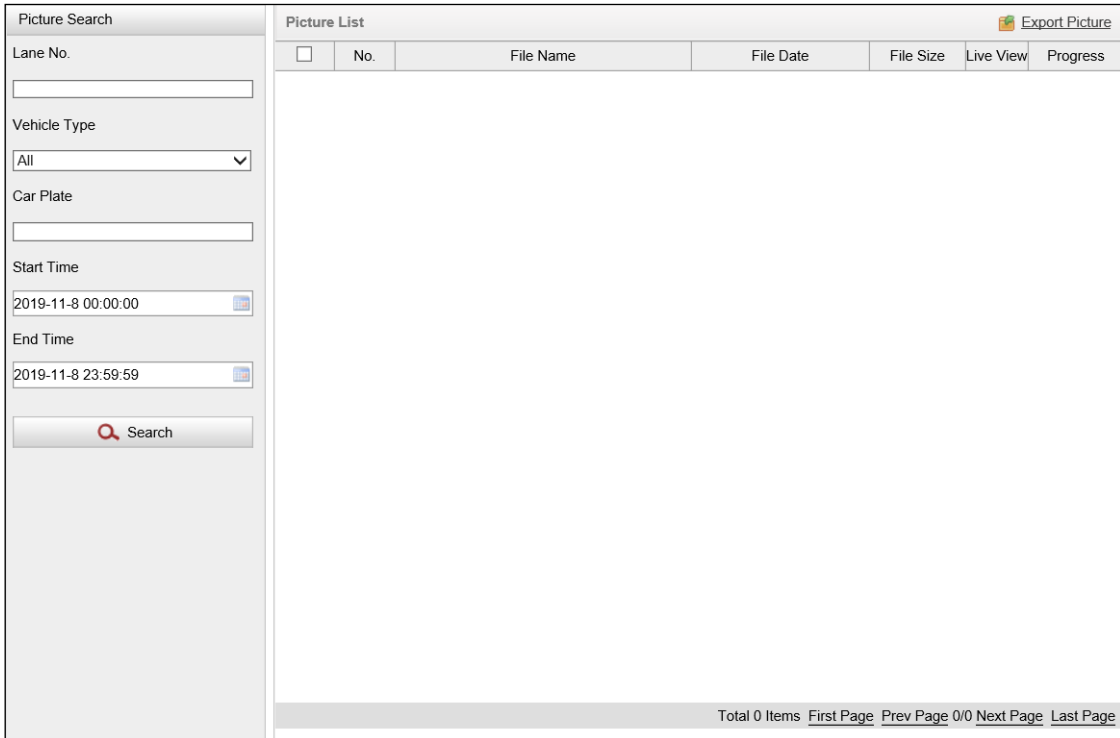

The screenshot displays the 'Picture Search' interface. On the left, there is a 'Picture Search' panel with the following fields: 'Lane No.' (text input), 'Vehicle Type' (dropdown menu set to 'All'), 'Car Plate' (text input), 'Start Time' (date/time picker set to '2019-11-8 00:00:00'), and 'End Time' (date/time picker set to '2019-11-8 23:59:59'). A 'Search' button is located below these fields. On the right, there is a 'Picture List' table with columns: 'No.', 'File Name', 'File Date', 'File Size', 'Live View', and 'Progress'. The table is currently empty. At the bottom right of the interface, there is a status bar that reads 'Total 0 Items' and navigation links: 'First Page', 'Prev Page 0/0', 'Next Page', and 'Last Page'. An 'Export Picture' button is located in the top right corner of the interface.

Figure 4-1 Search Picture

Step 2 Set the picture search conditions, including **Lane No.**, **Vehicle Type**, **Car Plate**, **Start Time**, and **End Time**.

Step 3 Click **Search** to search pictures. The matched pictures will be displayed in **Picture List**.

Step 4 Click **Export Picture** to export the pictures to your PC.

Chapter 5 Local Configuration

Purpose:

The local configuration refers to the parameters of the live view, record files and captured pictures. The record files and captured pictures are the ones you record and capture using the web browser and thus the saving paths of them are on the PC running the browser.

Step 1 Go to **Configuration > Local Configuration**.

Step 2 Configure the following settings:

- **Live View Parameters:** Set the protocol type and live view performance.
 - **Protocol:** TCP and UDP are selectable.
 - **TCP:** Ensures complete delivery of streaming data and better video quality, yet the real-time transmission will be affected.
 - **UDP:** Provides real-time audio and video streams.
 - **Live View Performance:** Set the live view performance to Least Delay, Balanced, Best Fluency.
 - **Rule Information:** It refers to the rules on your local browser, select enable to display the colored marks when the motion detection, face detection, or intrusion detection is triggered. E.g., enabled as the rules are, and the face detection is enabled as well, when a face is detected, it will be marked with a green rectangle on the live view.
 - **POS Information:** Enable the function, POS information of the detected target is dynamically displayed near the target in the live image.
 - The POS information of different functions is different. For example, ID and waitingtime for Queue Management, height for People Counting, etc.



NOTE

Feature Information is only available for certain camera models.

Live View Parameters			
Protocol Type	<input checked="" type="radio"/> TCP	<input type="radio"/> UDP	
Live View Performance	<input type="radio"/> Real-time	<input type="radio"/> Balanced	<input checked="" type="radio"/> Fluent
Rules	<input type="radio"/> Enable	<input checked="" type="radio"/> Disable	
Pos Info	<input type="radio"/> Enable	<input checked="" type="radio"/> Disable	

Figure 5-1 Live View Parameters

- **Record File Settings:** Set the saving path of the recorded video files. Valid for the record files you recorded with the web browser.

- **Record File Size:** Select the packed size of the manually recorded and downloaded video files. After the selection, the maximum record file size is the value you selected.
- **Save record files to:** Set the saving path for the manually recorded video files.
- **Picture and Clip Settings:** Set the saving paths of the captured pictures and clipped video files. Valid for the pictures you capture with the web browser.
 - **Save snapshots in live view to:** Set the saving path of the manually captured pictures in live view mode.
 - **Save download pictures to:** Set the saving path of the download pictures.
 - **Save scene picture to:** Set the saving path of the scene pictures.



You can click **Browse** to change the directory for saving the clips and pictures.

Step 3 Click **Save** to save the settings.

Chapter 6 System Configuration

Purpose:

You can configure the parameters on this page, including device information, serial ports, network parameters, time configuration, service, etc.

6.1 View Device Information

Go to **Configuration > Device Configuration > System Configuration > Device Information**.

- Device Name and Device No. can be changed as desired.
- Other information of the camera, such as Model, Serial No., Firmware Version, Encoding Version, Hardware Version, Number of Channels, Number of Alarm Input, Number of Alarm Output, and Smart Module Status are displayed for your reference. And the information cannot be edited in this menu.
- Algorithms Library Version information can be viewed but cannot be edited in this menu.

6.2 Set Installation Parameters

You can set the installation parameters of the camera.

Step 1 Go to **Configuration > Device Configuration > System Configuration > Installation Parameters**.

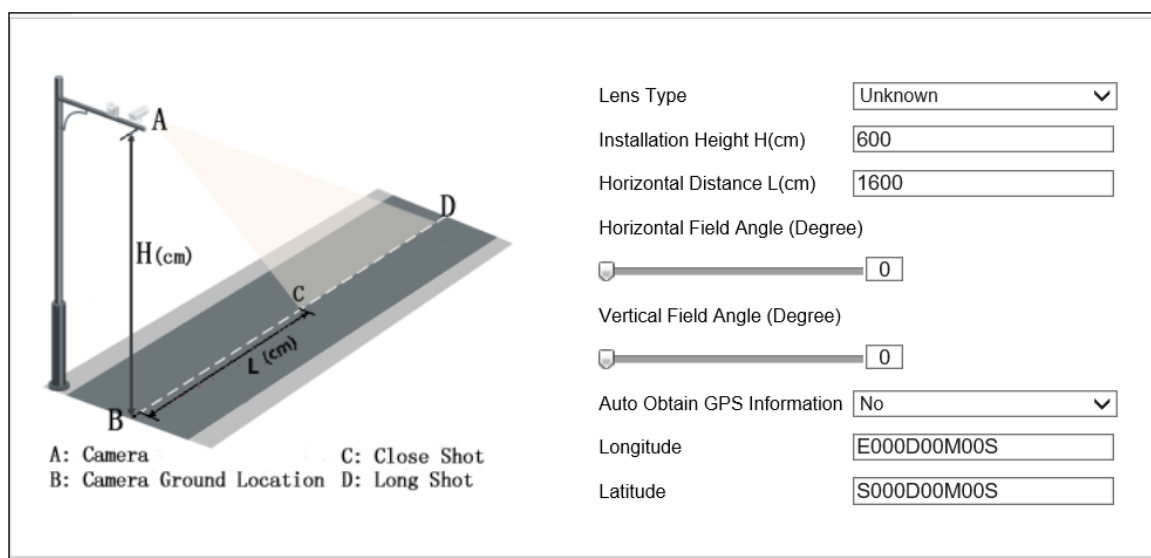

Figure 6-1 Installation Parameters

Step 2 Set the installation parameters according to the actual conditions.

Step 3 Click **Save** to save the settings.

6.3 Set Serial Ports

Purpose:

Configure the RS-485 parameters and RS-232 parameters in this page.

- The RS-485 ports are used to input signals related to traffic control, such as RS-485 radar and vehicle detector. The number of available RS-485 ports can be different according to different camera models.
- The RS-232 port can be used in two ways:
 - **Parameters Configuration:** Connect a computer to the camera through the serial port. Device parameters can be configured by using software such as HyperTerminal. The serial port parameters must be the same as the serial port parameters of the camera.
 - **Transparent Channel:** Connect a serial device directly to the camera. The serial device will be controlled remotely by the computer through the network.

Step 1 Go to **Configuration > Device Configuration > System Configuration > Serial Ports**.

RS-485 Parameters						
RS-485 No.	Baud Rate	Data Bit	Stop Bit	Parity	Flow Ctrl	Working Mode
1	38400	8	1	None	None	Application Mode Trigger

RS-232 Parameters	
Baud Rate	115200 bps
Data Bit	8
Stop Bit	1
Parity	None
Flow Ctrl	None
Work Mode	Console

[Advanced Settings](#)

Figure 6-2 Serial Ports Settings

Step 2 Configure the RS-485 and RS-232 parameters.

Step 3 Click **Save** to save the settings.

6.4 Set Network Parameters

Purpose:

Network parameters settings must be properly configured before you operate the camera over network. The camera supports both the IPv4 and IPv6. Both versions can be configured simultaneously without conflicting to each other, and at least one IP version should be configured.

Step 1 Go to **Configuration > Device Configuration > System Configuration > TCP/IP**.

Figure 6-3 TCP/IP Settings

Step 2 Configure the basic network settings, including the NIC Type, IPv4 or IPv6 Address, IPv4 or IPv6 Subnet Mask, IPv4 or IPv6 Default Gateway, IPv6 mode, Mac Address, MTU settings and Multicast Address.

- ANPR IP Address/Domain: ANPR listening IP address. Picture can be transferred from camera to server by setting ANPR IP address/domain and ANPR port in ANPR protocol.
- ANPR Port: ANPR listening port. Picture can be transferred from camera to server by setting ANPR IP address and ANPR port in ANPR protocol.
- Listening Host IP Address/Domain: Picture can be transferred from camera to server by setting listening host IP address/domain and listening host port.
- Listening Host Port: Picture can be transferred from camera to server by setting listening host IP address and listening host port.

 **NOTE**

- ANPR listening will be prior listening when ANPR listening and listening are both set.
- If you want to set Listening as prior listening, check Picture Uploading Listening, and set ANPR listening and listening.

Step 3 Configure the DNS server. Enter the preferred DNS server.

Step 4 DNS (Domain Name System) is a network system used to translate names into IP address.

Step 5 Click **Save** to save the above settings.

 **NOTE**

- The valid value range of MTU is 1280 to 1500.
- The Multicast sends a stream to the multicast group address and allows multiple clients to acquire the stream at the same time by requesting a copy from the multicast group address. Before utilizing this function, you have to enable the Multicast function of your router.
- A reboot is required for the settings to take effect.

6.5 Set Port

Purpose:

Configure the HTTP port, RTSP port, SDK port information to connect corresponding client.

Step 1 Go to **Configuration > Device Configuration > System Configuration > Port**.

HTTP Port	<input type="text" value="80"/>
<input checked="" type="checkbox"/> RTSP Port	
RTSP Port	<input type="text" value="554"/>
SDK Port	<input type="text" value="8000"/>
<input checked="" type="checkbox"/> SADP Port	

Figure 6-4 Port Configuration

Step 2 Configure the following parameters.

- **HTTP Port:** The default port number is 80, and it can be changed to any port No. ranges from 1 to 65536 which is not occupied, except 21 (FTP port) and 23 (Telnet port).
- **RTSP Port:** The default port number is 554 and it can be changed to any port No. ranges from 1 to 65536 which is not occupied, except 21 (FTP port) and 23 (Telnet port).

- **SDK Port:** The default server port number is 8000, and it can be changed to any port No. ranges from 2000 to 65535 which is not occupied.
- **SADP Port:** You can visit device via SADP by checking SADP port.

Step 3 Click **Save** to save the settings.

6.6 Set HTTPS

Purpose:

HTTPS provides authentication of the web site and associated web server that one is communicating with, which protects against Man-in-the-middle attacks. Perform the following steps to set the port number of https.

Example

If you set the port number as 443 and the IP address is 192.168.1.64, you may access the device by inputting `https://192.168.1.64:443` via the web browser.



NOTE

The HTTPS port can be only configured through the web browser.

Step 1 Go to **Configuration > Device Configuration > System Configuration > HTTPS**.

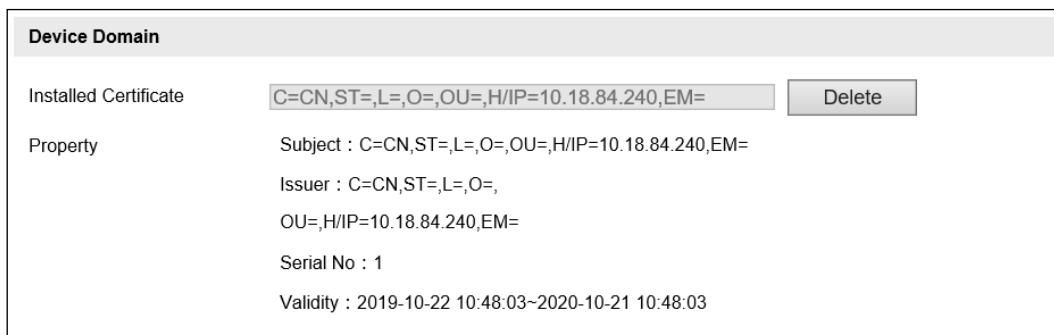

Figure 6-5 HTTPS Configuration

Step 2 Create and install the certificate.

- **OPTION 1:** Create private certificate.
 - 1) Click Create private certificate.
 - 2) Click Create and the following message box pops up as below.

The screenshot shows a 'Create' dialog box with the following fields and a tooltip:

- Country: Wrong country code, like CN.
- Domain Name/IP Address:
- Validity (Day):
- Password:
- State:
- District:
- Organization:
- Unit:
- Email:

Buttons: OK, Cancel

Figure 6-6 Create Private Certificate

- 3) Enter the parameters.
 - 4) Click **OK** to save the settings.
- **OPTION 2:** Signed certificate is available. Start the installation directly.
 - 1) Click Signed certificate is available. Start the installation directly.
 - 2) Click View to find the saving path of the certificate.
 - 3) Click **Install** to install the certificate.
 - **OPTION 3:** Create the certificate request first and continue the installation.
 - 1) Click Create the certificate request first and continue the installation.
 - 2) Click Create to create the certificate request.
 - 3) Click Download to download the certificate request and submit it to the trusted certificate authority for signature.
 - 4) After receiving the signed valid certificate, click View to find the saving path of the certificate and click Install to install it.
 - 5) (Optional) Click Delete to delete the certificate.
 - 6) There will be the certificate information after you successfully create and install the certificate.

6.7 Set Time

You can follow the instructions in this section to configure the time synchronization and DST settings.

- Time Settings

Step 1 Go to **Configuration > Device Configuration > System Configuration > Time**.

Step 2 Select the time zone of your region.

Step 3 You can adjust time manually. Or you can enable NTP (National Time Protocol) to synchronize time of your camera to the configured NTP server.

- Manual Synchronization

Step 1 Select **Synchronization Mode** as **Manual Synchronization**.

Step 2 Check Device Time. The grayed out device time shows the current camera time.

Step 3 Click “” to set the system time from the pop-up calendar.

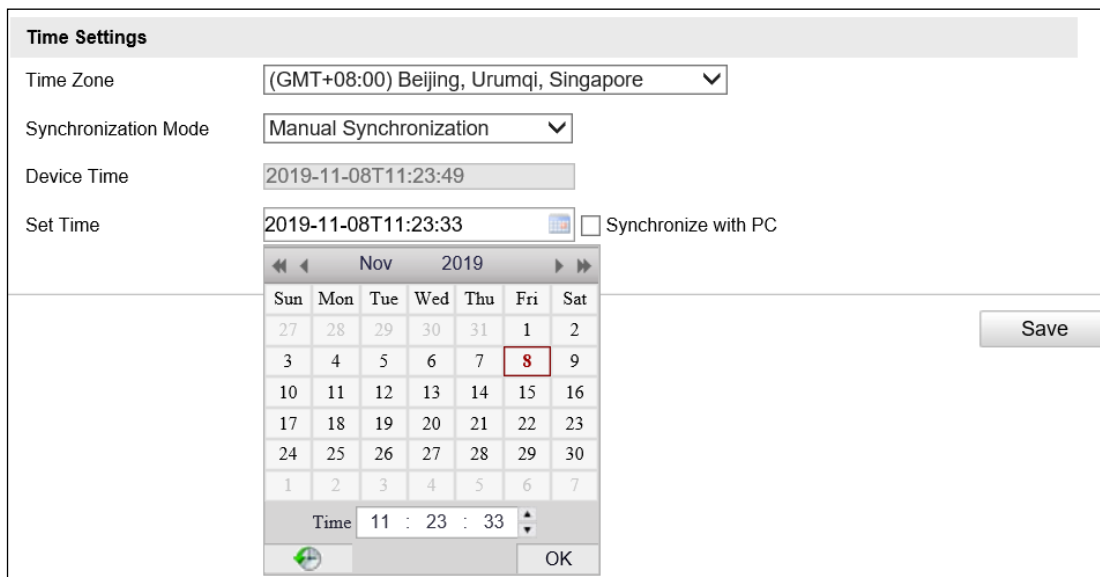

Figure 6-7 Manual Synchronization

Step 4 (Optional) you can also check **Synchronize with PC**. The camera time is synchronized with the time of your computer.

Step 5 Click **Save** to save the settings.

- NTP Synchronization

Step 1 Select Synchronization Mode as NTP Synchronization.

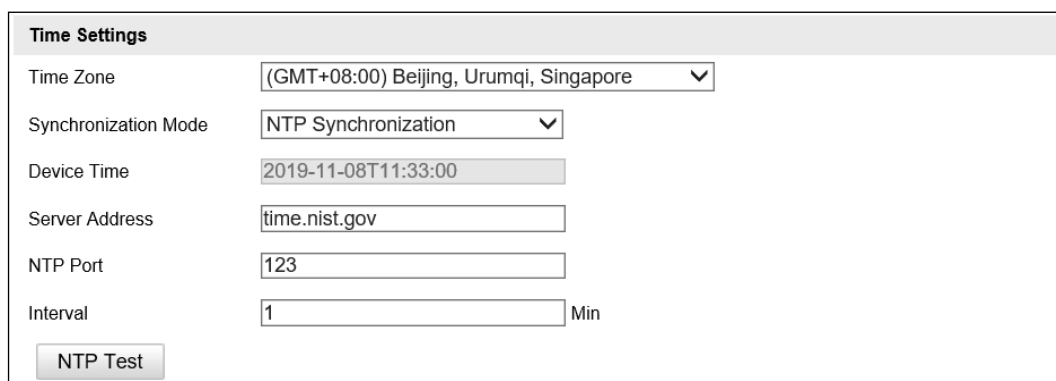

Figure 6-8 NTP Synchronization

Step 2 Configure the following settings:

- **Server Address:** IP address of NTP server.
- **NTP Port:** Port of NTP server.
- **Interval:** The time interval between the two synchronizing actions with NTP server.

 **NOTE**

If the camera is connected to a public network, you should use a NTP server that has a time synchronization function, such as the server at the National Time Center (IP Address: 210.72.145.44). If the camera is set in a customized network, NTP software can be used to establish a NTP server for time synchronization.

Step 3 Click **Save** to save the settings.

- Configuring DST (Daylight Saving Time)

Step 1 Go to **Configuration > Device Configuration > System Configuration > DST**.

Step 2 Check **Enable DST**.

Step 3 Set Start Time, End Time, and DST Bias.

Step 4 Click **Save** to save the settings.

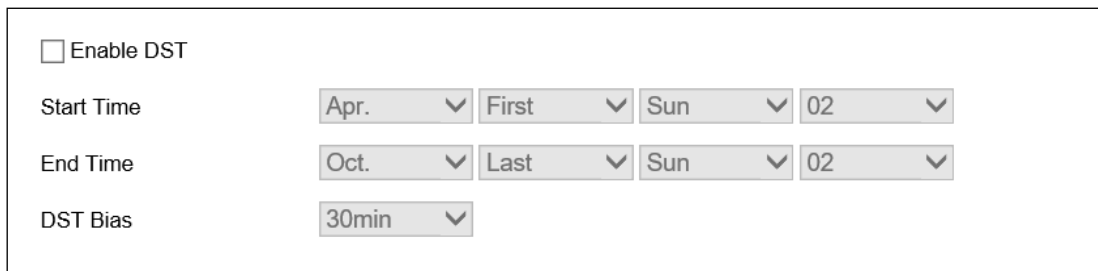

The screenshot shows the DST Settings configuration interface. It includes a checkbox for 'Enable DST' which is currently unchecked. Below this are three rows of dropdown menus: 'Start Time' (Apr., First, Sun, 02), 'End Time' (Oct., Last, Sun, 02), and 'DST Bias' (30min).

Figure 6-9 DST Settings

6.8 Set Service

Step 1 Go to **Configuration > Device Configuration > System Configuration > Service**.

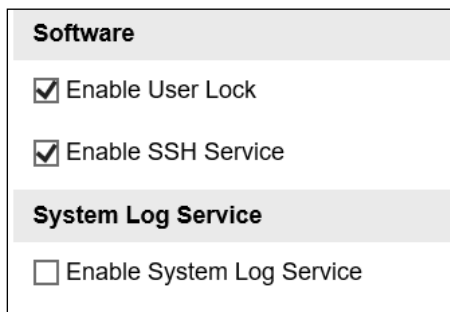

The screenshot shows the Service Configuration interface. It is divided into two sections: 'Software' and 'System Log Service'. Under 'Software', there are two checked checkboxes: 'Enable User Lock' and 'Enable SSH Service'. Under 'System Log Service', there is one unchecked checkbox: 'Enable System Log Service'.

Figure 6-10 Service Configuration

Step 2 Check **Enable User Lock** to enable user lock. If you enter wrong password for 7 times, the account will be locked for half hour.

Step 3 (Optional) Check **Enable SSH service**.

Step 4 (Optional) Check **Enable System Log Service**, to upload system log to log audit system.

Step 5 Click **Save** to save the settings.

6.9 Set EHome Protocol

Step 1 Go to **Configuration > Device Configuration > System Configuration> EHOME**.

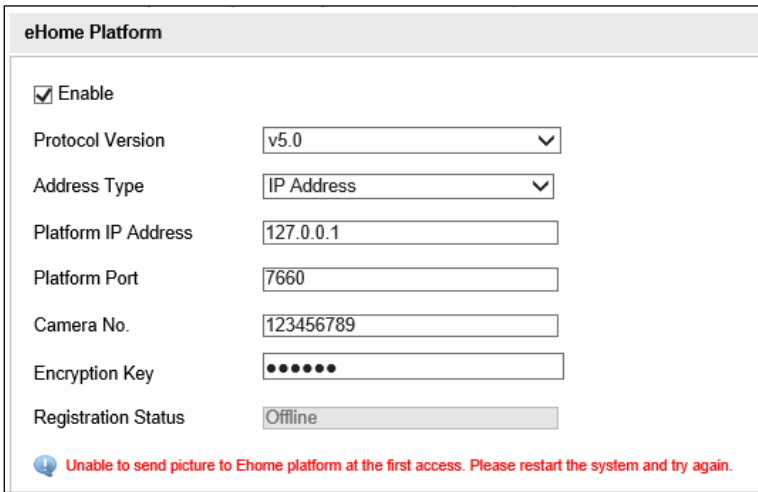

eHome Platform	
<input checked="" type="checkbox"/> Enable	
Protocol Version	v5.0
Address Type	IP Address
Platform IP Address	127.0.0.1
Platform Port	7660
Camera No.	123456789
Encryption Key	•••••
Registration Status	Offline

Unable to send picture to Ehome platform at the first access. Please restart the system and try again.

Figure 6-11 EHome Configuration

Step 2 Check **Enable**.

Step 3 Select **Protocol Version**.

Step 4 Select **Address Type**.

Step 5 Set corresponding EHome platform parameters.

- **Platform IP Address:** IP address of EHome platform.
- **Platform Port:** Port of EHome platform.
- **Camera No.:** No. of visited camera.

Step 6 Enter **Encryption Key**.

Step 7 Click **Save**.

6.10 Set Wiegand Parameters

Purpose:

You can configure Wiegand parameters to send card No. to communicate with the access control system.

Step 1 Go to **Configuration > Device Configuration > System Configuration> Wiegand Parameters.**

Step 2 Check **Enable.**

Step 3 Select **Communicate Direction.**

Step 4 Select **Wiegand Mode.**

Step 5 Click **Save.**



Only license plate recognition system supports Wiegand function.

Chapter 7 Encoding and Storage Configuration

Purpose:

You can configure the encoding and storage related parameters from this page, including video encoding, image encoding, ROI, record schedule, redundant storage, FTP, and cloud storage.

7.1 Set Video Encoding

For certain camera models, you can configure parameters for available video streams, for example, the main stream, the sub-stream, etc. And you can also customize additional video streams for further needs.

- On **Video** page, set-up available video streams.
- On **Custom Video** page, add extra video streams

Step 1 Go to **Configuration > Device Configuration > Encoding and Storage > Video Encoding**.

Main Stream Parameters	
Stream Type	Video Audio
Bitrate	4096Kbps
Frame Rate	25
Resolution	2688*1520
SVC	OFF
Advanced Settings	
Sub Stream Parameters	
Stream Type	Video Stream
Bitrate	2048Kbps
Frame Rate	25
Resolution	1920*1080P
SVC	OFF
Advanced Settings	
Third Stream Parameters	
Stream Type	Video Stream
Bitrate	4096Kbps
Frame Rate	25
Resolution	1280*720P
SVC	OFF
Advanced Settings	

Figure 7-1 Video Settings

Step 2 Select the Stream Type. Supported stream types are listed in the drop-down list.

 **NOTE**

The main stream is usually for recording and live view with good bandwidth, and the sub-stream can be used for live view when the bandwidth is limited.

Step 3 You can customize the following parameters for the selected stream type.

- **Stream Type:** Select the stream type to video stream, or video & audio composite stream. The audio signal will be recorded only when the **Video Type** is **Video Audio**.
- **Bitrate:** Select the bitrate of the video.
- **Frame Rate:** Set the frame rate. The frame rate is to describe the frequency at which the video stream is updated and it is measured by frames per second (fps). A higher frame rate is advantageous when there is movement in the video stream, as it maintains image quality throughout.
- **Resolution:** Select the resolution of the video output.
- **SVC:** Scalable Video Coding is an extension of the H.264/ MJPEG and H.265 standard. Select OFF/ON to disable/enable the SVC function. Select Auto and the device will automatically extract frames from the original video when the network bandwidth is insufficient.
- **Bitrate Type:** Select the bitrate type to constant or variable.
- **Video Quality:** When bitrate type is selected as Variable, 6 levels of video quality are selectable.
- **Max. Bitrate:** Set the max. bitrate from 32 to 16384 Kbps. The higher value corresponds to the higher video quality, but the better bandwidth is required.

 **NOTE**

The maximum limit of the max. bitrate value varies according to different camera platforms. For certain cameras, the maximum limit is 8192 Kbps or 12288 Kbps.

- **Profile:** When you select H.264 or H.265 as video encoding, you can set the profile. Selectable profiles vary according to camera models.
- **I Frame Interval:** Set I Frame Interval as default.
- **Video Encoding:** The camera supports multiple video encodings types, such as H.264, H.265, and MJPEG. Supported encoding type for different stream types may differ. H.265 is a new encoding technology. Compared with H.264, it reduces the transmission bitrate under the same resolution, frame rate and image quality.

 **NOTE**

- Selectable video encoding types may vary according to different camera modes.
- Upgrade your video player to the latest version if live view or playback does not work properly due to compatibility.

Step 4 Click **Save** to save the settings.



The video parameters vary according to different camera models. Refer to the actual display page for camera functions.

7.2 Set Image Encoding

Step 1 Go to **Configuration > Device Configuration > Encoding and Storage > Image Encoding**.

Capture Resolution	1920*1080
JPEG Picture Size	512

Figure 7-2 Image Encoding

Step 2 Select Capture Resolution.

Step 3 Enter JPEG Picture Size. The captured pictures are saved as JPEG files, and JPEG Picture Size refers to max. size of each captured picture.

Step 4 Click **Save** to save the settings.

7.3 Set ROI

Purpose:

ROI (Region of Interest) encoding helps to discriminate the ROI and background information in video compression, which means, the technology assigns more encoding resource to the region of interest, thus to increase the quality of the ROI whereas the background information is less focused.



ROI function varies according to different camera models.

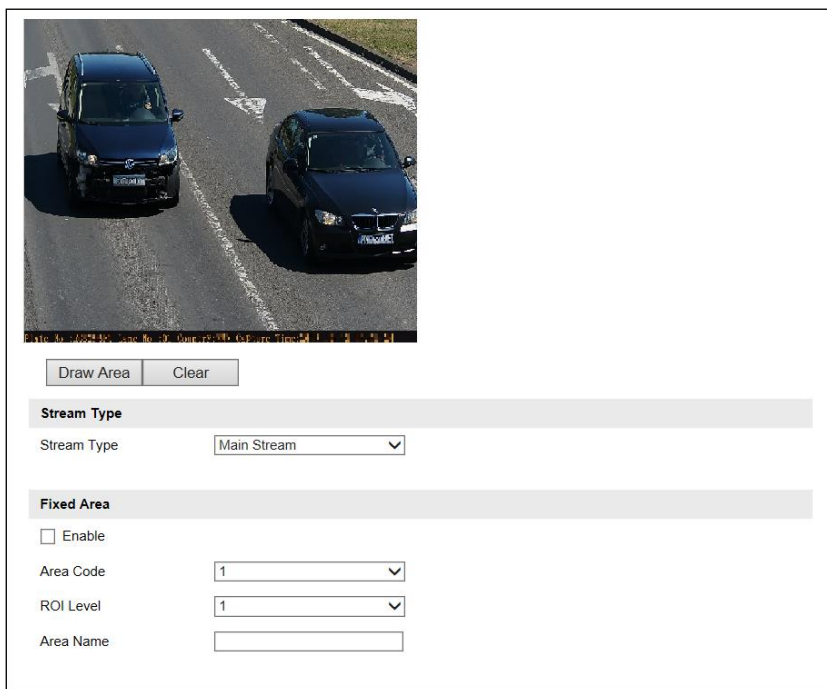

Figure 7-3 Region of Interest Settings

Step 2 Enter the ROI settings interface: **Configuration > Device Configuration > Encoding and Storage > ROI**.

Step 3 Select the Stream Type for ROI.

Step 4 Check the checkbox of Enable under Fixed Area.

Step 5 Set Fixed Area for ROI.

- 1) Select the Area Code from the drop-down list.
- 2) Check the **Enable** checkbox to enable ROI function for the chosen region.
- 3) Click **Draw Area**. Click and drag the mouse on the view screen to draw a red rectangle as the ROI region. You can click **Clear** to cancel former drawing. Click **Stop Drawing** when you finish.
- 4) Select the ROI level.
- 5) Enter a region name for the chosen region.
- 6) Click **Save** the save the settings of ROI settings for chosen fixed area.
- 7) Repeat steps (1) to (6) to setup other fixed area.

NOTE

ROI level means the image quality enhancing level. The larger the value is, the better the image quality would be.

7.4 Set Record Schedule

Purpose:

You can follow the instructions to configure the scheduled recording. By default, the record files of scheduled recording are stored in the TF card.

Steps:

Step 1 Go to **Configuration > Device Configuration > Encoding and Storage > Record Schedule.**

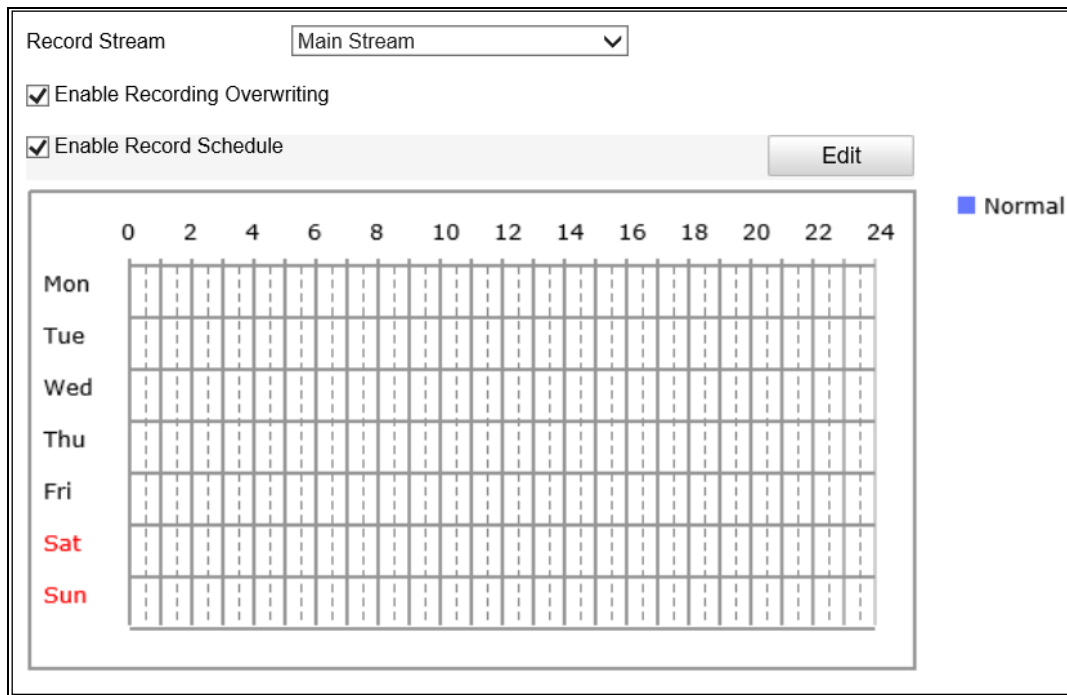

Figure 7-4 Record Schedule Configuration

Step 2 Select Record Stream.

Step 3 (Optional) Check **Enable Recording Overwriting.**

- If you enable the function, when the storage space is full, the former record files will be overwritten.
- If you disable the function, when the storage space is full, the notice that the space is full will be reminded.

Step 4 Check **Enable Record Schedule.**

Step 5 Click **Edit** to edit the record schedule.

Edit Schedule

Mon Tue Wed Thu Fri Sat Sun

All Day Customize

Normal

Period	Start Time	End Time	Record Type
1	00:00	00:00	Normal
2	00:00	00:00	Normal
3	00:00	00:00	Normal
4	00:00	00:00	Normal

Copy to Week Select All

Mon Tue Wed Thu Fri Sat Sun

Copy OK Cancel

Figure 7-5 Edit Record Schedule

Step 6 Select the day to set the record schedule.

Step 7 Set all-day record or segment record.

- If you want to configure the all-day recording, check the **All Day** checkbox.
- If you want to record in different time sections, check the **Customize** checkbox. Set the **Start Time** and **End Time**.

 **NOTE**

- The time of each segment cannot be overlapped. Up to 4 segments can be configured.
- The default record type is Normal and you cannot edit it.

Step 8 Check **Select All** and click **Copy** to copy settings of this day to the whole week. You can also check any of the checkboxes before the date and click **Copy**.

Step 9 Click **OK** to save the settings and exit from the interface.

Step 10 Click **Save** to save the settings.

7.5 Set Storage Management

Purpose:

You can manage the storage, view the TF card information, format the TF card, etc.

Step 1 Go to **Configuration > Device Configuration > Encoding and Storage > Redundant Storage**.

Device List							Format
<input type="checkbox"/>	HDD No.	Capacity	Free Space	Status	Type	Property	Progress
<input checked="" type="checkbox"/> Auto-Initialize Redundant Storage							
<input checked="" type="checkbox"/> Auto-Upload Data in Redundant Storage							
HDD Quota							
Picture Capability	<input type="text" value="0"/>					MB	
Video Capability	<input type="text" value="0"/>					MB	
Capture Quota Ratio	<input type="text" value="100"/>					%	
Video Quota Ratio	<input type="text" value="0"/>					%	

Figure 7-6 Redundant Storage Configuration

Step 2 View the HDD information such as Capacity, Free Space, Status, etc.

Step 3 (Optional) Check the HDD and click **Format** to format it.

Step 4 (Optional) Check **Auto-Initialize Redundant Storage**. Then the TF card in the redundant storage can be formatted automatically. The storage is used for store captured pictures, traffic violation video, and log.

Step 5 (Optional) Check **Auto-Upload Data in Redundant Storage**.

Step 6 Configure the HDD Quota.

- 1) Enter the Capture Quota Ratio.
- 2) Enter the Video Quota Ratio.

NOTE

- The edited quota parameters will take effect after formatting the HDD.
- The Capture Quota Ratio ranges from 0 to 100%.
- The sum of Capture Quota Ratio and Video Quota Ratio should be 100%.

7.6 Set FTP

Purpose:

You can configure the FTP server related information to enable the uploading of the captured pictures to the FTP server.

NOTE

We have three ways to storage data (priority ranking from prior to less prior): FTP, SDK arming and local memory card storage. If FTP is enabled, the SDK arming and local memory card storage are invalid. If SDK arming is enabled, memory card storage is invalid.

Step 1 Go to Configuration > Device Configuration > Encoding and Storage > FTP.

Upload to FTP

Upload Additional Information to FTP

Enable FTP Enable One ▼

Figure 7-7 FTP Configurations

Step 2 Check **Upload Additional Information to FTP** to enable the uploading function.

If **Upload Additional Information to FTP** is enabled, the additional information of passed vehicle will be uploaded to FTP in binary form. If it is disabled, only captured pictures will be uploaded to FTP.

Step 3 Select the FTP uploading mode.

- **Disable:** No data will be uploaded to FTP.
- **Enable One:** Data can be uploaded to one FTP server.

1) Select Enable One.

Upload to FTP

Upload Additional Information to FTP

Enable FTP Enable One ▼

FTP1

Server Address	<input type="text" value="0.0.0.0"/>	Directory Structure	Save in Root Dire ▼
Port	<input type="text" value="21"/>	Parent Directory	None ▼
User Name	<input type="text"/>	Level 2 Directory	None ▼
Password	<input type="text"/>	Level 3 Directory	None ▼
Confirm	<input type="text"/>	Level 4 Directory	None ▼

Not Upload Plate Close-up

Figure 7-8 Upload to One FTP Server

- 2) Configure the FTP server parameters, including **Server Address**, **Port**, **User Name**, and **Password**.
- 3) Select the **Directory Structure** to save the files. **Save in Root Directory**, **Save in Parent Directory**, and **Save in Level 2/3/4 Directory** are selectable.
- 4) Select the content in different directories. For the **Parent Directory**, you can select **Device Name**, **Device No.**, and **Device IP Address**. For the **Level 2/3/4 Directory**, you can select **Camera Name**, **Camera No.**, **Device IP Address**, etc.
- 5) (Optional) Check **Not Upload Plate Close-up**, the close-up of the license plate will not be uploaded to the FTP server.

Step 4 Configure the **Name Rule**.

- 1) Select the **Separator**.
- 2) Select the **Elements** of each name.

Name Rule		Separator:
No.	Name	Elements
1	Name1	Device IP Address
2	Name2	Time
3	Name3	Vehicle Speed
4	Name4	None
5	Name5	None
6	Name6	None
7	Name7	None
8	Name8	None
9	Name9	None
10	Name10	None
11	Name11	None
12	Name12	None
13	Name13	None
14	Name14	None
15	Name15	None

Figure 7-9 Name Rule Configuration

Step 5 Configure the **OSD Information** to set file name as required.

OSD Information	
Location	<input type="text"/>
Intersection No.	<input type="text"/>
Device No.	<input type="text"/>
Checkpoint 1	<input type="text"/>
Direction No.	<input type="text"/>
Direction	<input type="text"/>

Figure 7-10 OSD Information

Step 6 Click **Save** to save the settings.

7.7 Set Cloud Storage

Purpose:

When device storage is constrained by storage space, you can enable Cloud Storage to store captured pictures of vehicles and license plates to the cloud.

Step 1 Go to **Configuration > Device Configuration > Encoding and Storage > Cloud Storage**.

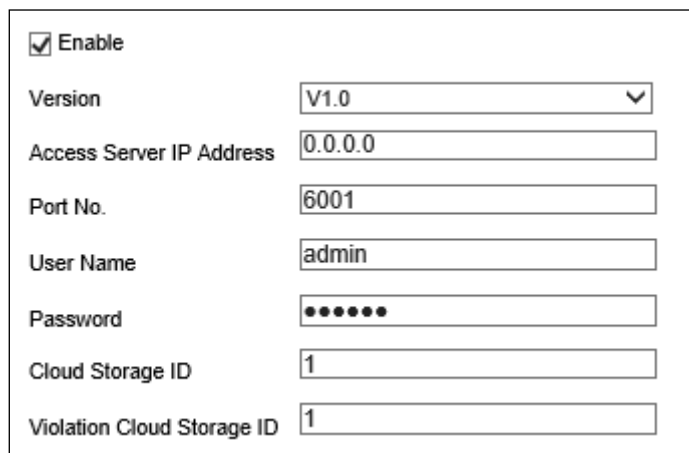

Figure 7-11 Cloud Storage

Step 2 Check **Enable** to enable cloud storage.

Step 3 Set the corresponding parameters.

- **Access Server IP Address** and **Port No.:** Enter the IP address and port No. of the cloud storage server.
- **User Name** and **Password:** The user name and password for logging in to the cloud storage server.
- **Cloud Storage ID** and **Violation Cloud Storage ID:** Storage area No. of pictures uploaded by the storage device on the cloud storage server side.

Step 4 Click **Save**.

7.8 Set Upload Protocol

Purpose:

The device supports multiple upload protocols.

Step 1 Go to **Configuration > Device Configuration > Encoding and Storage > Upload Protocol**.

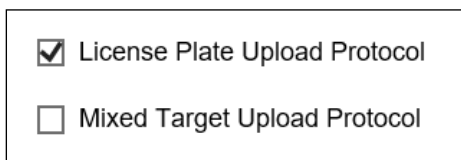

Figure 7-12 Upload Protocol

Step 2 Check the upload content according to actual demands.

- **License Plate Upload Protocol:** Uploads license plate information.
- **Mixed Target Upload Protocol:** Uploads the mixed target information.

Step 3 Click **Save**.



NOTE

Upload protocol function may vary with different models. Please refer to actual device.

Chapter 8 Text Overlay Configuration

Purpose:

Configure the OSD on the captured pictures and videos.

8.1 Set Capture Overlay

Purpose:

You can configure the overlay information of the captured picture.

Steps:

Step 1 Go to **Configuration > Device Configuration > Text Overlay > Capture Overlay Configuration**.

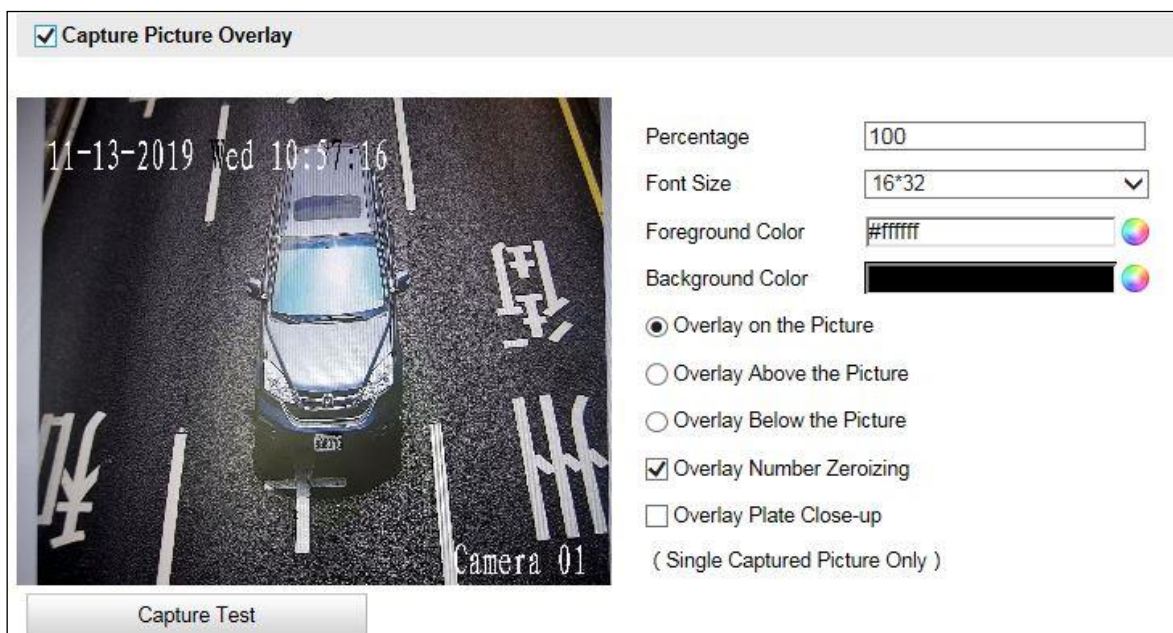

Figure 8-1 Single Picture Overlay

Step 2 Check Capture Picture Overlay.

Step 3 Configure the parameters below.

- **Percentage:** the percentage of the information overlaid on the picture.
- **Font Size:** the font size of the overlay information.
- **Foreground Color:** the foreground color of the overlay information.
- **Background Color:** the background color of the overlay information.

Step 4 Set the overlay text position.

- **Overlay on Picture:** Display the information on the picture.



Figure 8-2 Overlay on Picture

- **Overlay Above the Picture:** Display the information on the top.



Figure 8-3 Overlay Above the Picture

- **Overlay Below the Picture:** Display the information on the bottom.







Figure 8-4 Overlay Below the Picture

Step 5 (Optional) Check **Overlay Number Zeroing**, to zero out the overlaid information.

Step 6 (Optional) Check **Overlay Plate Close-up** on the captured picture.

Step 7 Configure the overlay information.

- 1) Check the overlay information or check **Select All** to display all the overlay information.
- 2) Configure the overlay information.

- **Overlay Information:** You can edit the details of the overlay information type.
- **Overlay Position:** For some information you want to display separately, check the checkbox of the desired items. For the other items, they will be displayed together.
- **Space:** It stands for the length of blank space between the last character of the first item and the first character of the next item.
- **Line Break Characters:** When you add Line Break Characters to an item, the item is displayed as a new paragraph, and the number stands for the scale of space above the paragraph.
-  / : Click  to move the overlay position up. Click  to move the overlay position down.

8.2 Set OSD Settings

Purpose:

You can configure the OSD settings.

Step 1 Go to **Configuration > Device Configuration > Text Overlay > OSD Settings**.

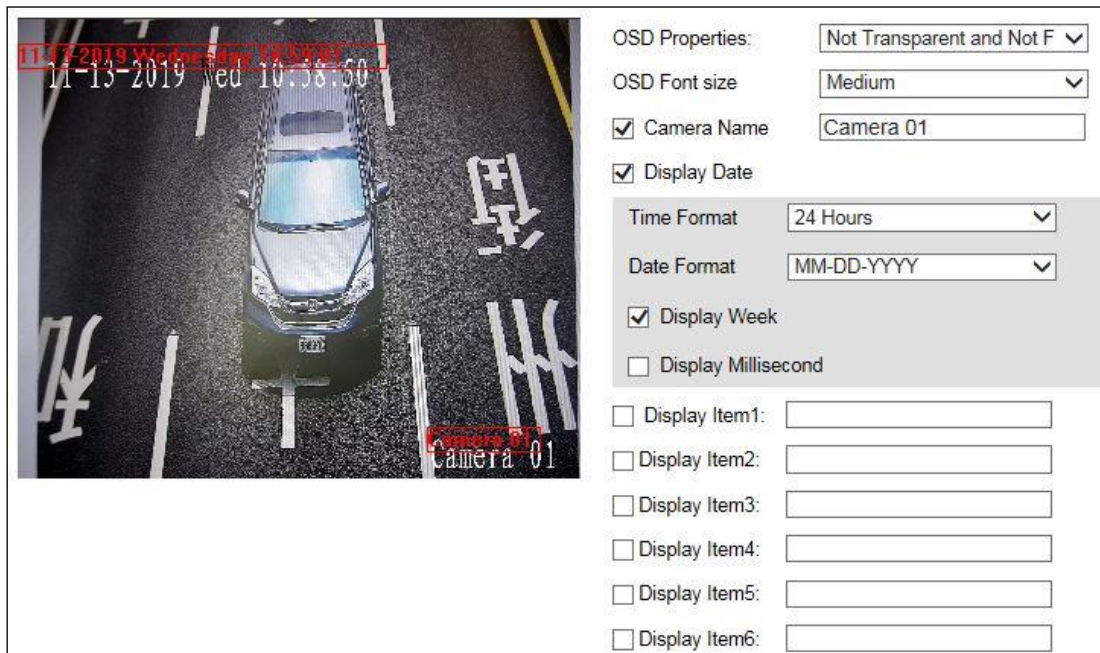

Figure 8-5 Capture Overlay Configuration

Step 2 Configure the corresponding parameters.

- **OSD Attribute:** the OSD information properties overlaid on the picture.
- **OSD Size:** the font size of the overlay information.
- **OSD Color:** the color of the overlay information.
- **Alignment:** Align Right and Align Left are selectable.
- **Display Name:** Check it to display camera name on the picture.
- **Display Date:** Check it to display date information on the picture.
- **Time Format:** 24-hour and 12-hour are selectable.
- **Date Format:** The date format overlaid on the picture.
- **Display Week:** Check it to display week information on the picture.
- **Millisecond:** Check it to display millisecond information on the picture.
- **Display Item:** You can check display item(s) and enter information as need, to overlay them on the picture.

Step 3 Click **Save** to save the settings.

Chapter 9 Capture Parameters Configuration

Purpose:

You can configure capture parameters before capturing, and edit capture parameters when the default capture parameters cannot meet actual needs.

9.1 Set License Plate Parameters

Step 1 Go to **Configuration > Device Configuration > Capture Parameters > License Parameters**.

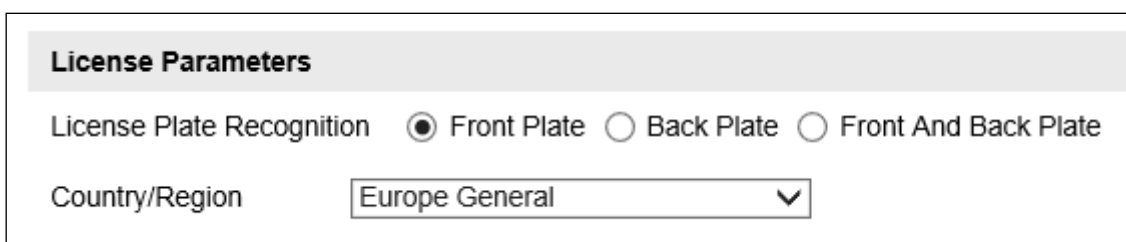

License Parameters

License Plate Recognition Front Plate Back Plate Front And Back Plate

Country/Region

Figure 9-1 License Parameters Configuration

Step 2 Select License Plate Recognition as Front Plate or Back Plate. You should select **Front Plate** when you want to capture license plate number in vehicle head direction, select **Back Plate** when you want to capture license plate number in vehicle tail direction, and select **Front and Back Plate** when you want to capture license plate number in vehicle head and tail direction.

9.2 Set Flash Light Parameters

Step 1 Go to **Configuration > Device Configuration > Capture Parameters > Flash Light Parameters**.

Step 2 Select a tab corresponded with the flash light control port.

NOTE

The camera supports IO:1 and IO: 2. IO:1 is the built-in flash light. IO:2 connects external flash lights.



IO Output Mode	Constant Light Mode	▼
Duty Ratio	35	[0-70]
<input type="checkbox"/>	Control Constant Light by Brightness	
<input checked="" type="checkbox"/>	Control Constant Light by Schedule	
Start Time	00:00	
End Time	23:59	

Figure 9-2 Flash Light Parameters Configuration

Step 3 Select IO Output Mode according to accessed light. **Constant Light Mode** is available.

- 1) Enter Duty Ratio value. It controls the power level of the flash light. 0 means light off, and 70 means full-power. It is recommended that the duty ratio value is less than 40.

 **NOTE**

Duty ratio can only be set in IO:1.

- 2) Set light on/off control mode. The on/off status can be controlled automatically or on schedule.

- **Auto:** Check **Control Constant Light By Brightness**. Set the brightness threshold.
- **Schedule:** Check **Control Constant Light by Schedule**. Set the start time and end time.

Step 4 (Optional) Copy settings of current port to other ports by checking desired port number.

 **NOTE**

Port number may vary from different devices. Please refer to actual device.

Step 5 Click **Save** to save the settings.

9.3 Set Vehicle Feature

Step 1 Go to **Configuration > Device Configuration > Capture Parameters > Vehicle Feature**.

Vehicle Feature

Vehicle Color Recognition

Enable Car Logo Recognition

Enable Body Picture Matting

Target Cutting Ratio

Target Zooming Ratio

Figure 9-3 Vehicle Feature Configuration

Step 2 Check Vehicle Features types. You can check Vehicle Color Recognition, Enable Car Logo Recognition.

Step 3 Set body picture matting parameters.

- 1) Check **Enable Body Picture Matting**.
- 2) Select **Target Cutting Ratio** and **Target Zooming Ratio**.

Step 4 Click **Save** to save the settings.

Chapter 10 Image Parameters Configuration

Purpose:

Configure general parameters, video parameters, picture parameters and ICR on this page.

10.1 Set General Parameters

Purpose:

General parameters refer to the image parameters applying to both video image and capture image, such as saturation, sensitivity, lens type, sharpness, white balance, gamma correction, and brightness enhancement.

Step 1 Go to **Configuration > Device Configuration > Image Parameters > General Parameter**.

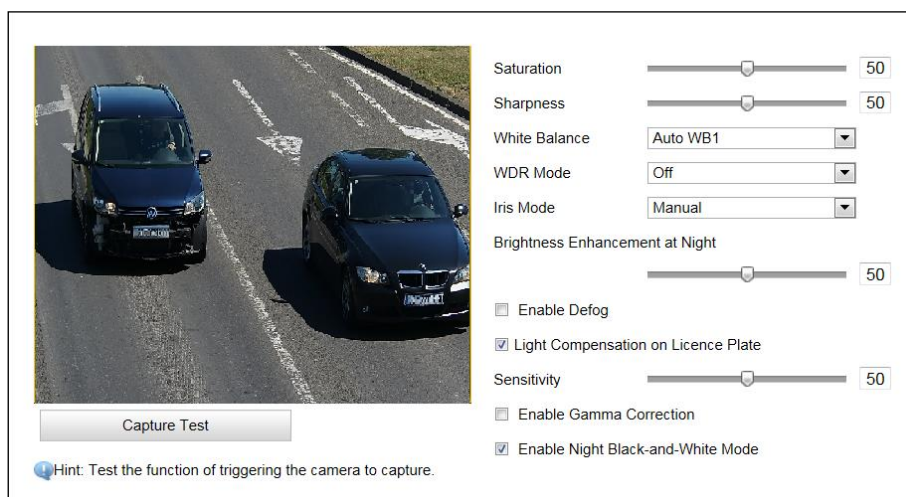

Figure 10-1 General Parameters Configuration

Step 2 Set the image **Saturation**, **Sharpness** and **White balance mode**.

- **Saturation** describes the colorfulness of the image color, which ranges from 0 to 100.
- **Sharpness** describes the edge contrast of the image, which ranges from 1 to 100.
- **White Balance** is the white rendition function of the camera used to adjust the color temperature according to the environment.

Step 3 Select **WDR Mode**. WDR and Off are selectable. Wide Dynamic Range is used when there is a high contrast of the bright area and the dark area of the scene.

Step 4 Select **WDR Switch**. On, Time and Brightness are selectable.

- **Time:** Activate WDR function on schedule. Set the start time and end time.

- **Brightness:** Active WDR function automatically. Set the brightness threshold.
- **WDR Level:** higher level means stronger effect.

Step 5 Select **Iris Mode**. **Auto** and **Manual** are selectable.

Step 6 Adjust **Brightness Enhancement at Night**. It ranges from 0 to 100.

Step 7 (Optional) Check **Enable Defog**. You can enable the defog function when the environment is foggy and the image is misty. It enhances the subtle details so that the image appears clearer.

Step 8 (Optional) Check **Light Compensation on License Plate**. Adjust the sensitivity to 0 to 100 if you enable the function.

Step 9 (Optional) Check **Enable Gamma Correction**, and adjust the correction level from 0 to 100. Gamma correction can enhance picture contrast, but bring noise at the same time.

Step 10 (Optional) Check **Enable Light Compensation Correction** to adjust the license plate brightness automatically if the license plate or scene brightness cannot be adjusted via supplement light. And adjust Correction Level from 0 to 100.

Step 11 (Optional) Check **Enable Black and White Mode at Night**. When ICR is in night mode, you can check **Enable Black and White Mode at Night** to keep the video in black and white mode.

Step 12 (Optional) Click **Capture Test** to test the effects after you complete the adjustment.

Step 13 (Optional) Reboot the device if you enable image rotation. For other parameters, they will take effect in real time.

10.2 Set Video

Purpose:

The camera supports dual-shutter. One shutter for video image and the other one for capture image. You can configure shutter parameters for video image.

Step 1 Go to **Configuration > Device Configuration > Image Parameters > Video**.

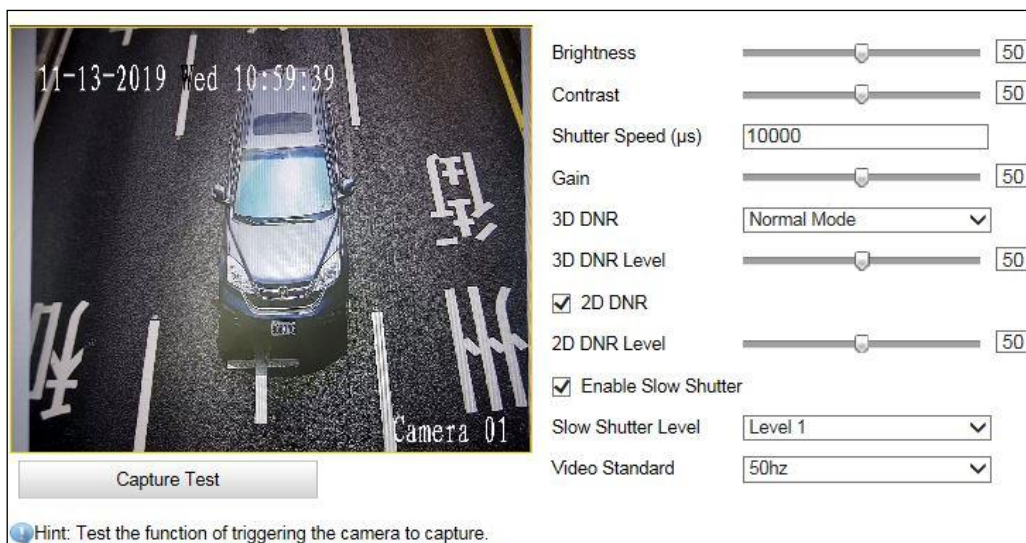

Figure 10-2 Video Image Configuration

Step 2 Adjust **Brightness** [0 to 100].

Step 3 Adjust **Contrast** [0 to 100]. It refers to the color contrast between the brightest part and darkest part.

Step 4 Enter **Shutter Speed** [120 to 40000 μ s]. It refers to the length of time that a camera's shutter remains open.

Step 5 Adjust **Gain** [0 to 100]. It refers to the ratio the output signal and input signal.

Step 6 Select **Hue Range** to adapt the display.

Step 7 Select **3D DNR**. It refers to the brightness noise reduction, saturation noise reduction and original data reduction in the separation of video signals. Comparing with the general 2D digital noise reduction, the 3D digital noise reduction function processes the noise between two frames besides processing the noise in one frame. The noise will be much less and the video will be clearer.

- 1) If you select **Normal Mode**, adjust **3D DNR Level** from 0 to 100.
- 2) If you select **Expert Mode**, adjust **Spatial Intensity** and **Time Intensity** from 0 to 100.

Step 8 (Optional) Check **2D DNR**, and adjust **2D DNR Level** from 0 to 100.

Step 9 (Optional) Check **Slow Shutter** and select slow shutter level.

In slow shutter mode, the shutter speed will automatically decrease in low illumination conditions to maintain clear video images by increasing the exposure time. Higher level means lower shutter speed.

Step 10 Select **Video Standard** to change the P/N value.

Step 11 (Optional) Click **Capture Test** to test the effects.

10.3 Set Picture

Purpose:

The camera supports dual-shutter. One shutter for video image and the other one for captured image. You can configure shutter parameters for captured image.

Step 1 Go to **Configuration > Device Configuration > Image Parameters > Picture**.

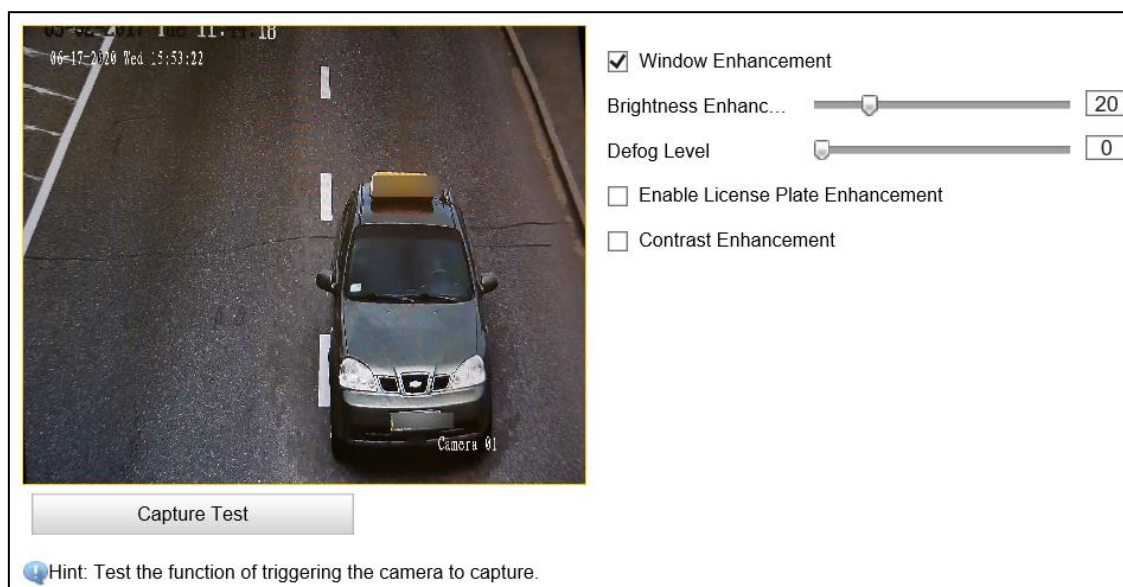

Figure 10-3 Captured Image Configuration

Step 2 Check **Window Enhancement**, and set **Brightness Enhancement Level** and **Defog Level**.

Step 3 Check **Enable License Plate Enhancement**, and set **License Plate Enhancement Level**, **License Plate Contrast Grade**, and **License Plate Background Enhancement**.

Step 4 Check **Contrast Enhancement**.

- 1) Select mode as On, Time, Brightness.
 - **Time:** Activate the function on schedule. Set the start time and end time.
 - **Brightness:** Active the function automatically. Set the brightness threshold.
 - 2) Set enhancement level from 0 to 100. Higher value means stronger effect.
 - 3) Set Halo Suppression Level from 0 to 100. Higher value means stronger effect.

10.4 Set ICR

Purpose:

IR Cut Filter is used to block or reflect infrared wavelengths but pass visible light. This series of cameras support auto switch of ICR to realize the 24-hour surveillance.

 **NOTE**

ICR configuration is not supported by all camera models of this series.

Step 1 Go to **Configuration > Device Configuration > Image Parameters > ICR.**

Step 2 Select **ICR Mode**. Do not Switch, Auto-switch, Manual Switch, and Scheduled Switch are selectable.

- **Do not switch:** The ICR always stays in day mode by default.
- **Auto Switch:** The ICR switches according to the brightness. Adjust **Threshold** from 0 to 100.

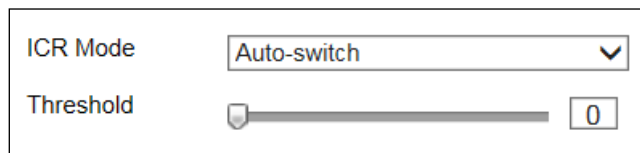

Figure 10-4 Auto-Switch

- **Manual Switch:** If you set the ICR mode as Manual Switch, it offers you an option to select day or night.

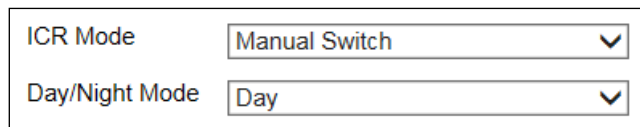
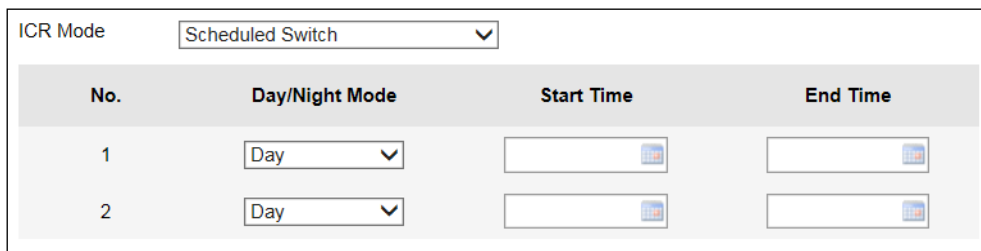

Figure 10-5 Manual Switch

- **Scheduled Switch:** The ICR switches according to the configured time schedule. You can set the Start Time and End Time of Day/Night Mode according to local time.



No.	Day/Night Mode	Start Time	End Time
1	Day		
2	Day		

Figure 10-6 Scheduled Switch

Step 3 Click **Save** to save the settings.

Chapter 11 Entrances and Exits Configuration

11.1 Set White-Black List

Purpose:

You can configure the vehicle whitelist and blacklist, and import, export, add, edit, delete, or search the list.

Before you start:

Make sure the TF card is installed for the camera and can work normally.



NOTE

The whitelist and blacklist function can be used normally only after the TF card is installed and works normally.

Step 1 Go to **Configuration > Device Configuration > Entrances and Exits > White-Black List**.

The screenshot shows a web-based configuration interface for the White-Black List. It features two main sections: 'Search List' and 'Delete List'. The 'Search List' section has a 'Filter by' dropdown set to 'All Types' and a 'Keywords' input field with a 'Search' button. The 'Delete List' section has a 'Delete Type' dropdown set to 'Delete All' and a 'Keywords' input field with a 'Delete' button. Below these sections are four buttons: 'Add', 'Edit', 'Import', and 'Export'. A table with the following columns is displayed: 'No.', 'License Plate No.', 'Belong to', 'Card No.', 'Effective Start Time', and 'Effective End Time'. The table is currently empty. At the bottom of the interface, a status bar indicates 'Total 0 Items' and provides navigation links: 'First Page', 'Prev Page 0/0', 'Next Page', and 'Last Page'.

Figure 11-1 Whitelist and Blacklist Configuration

Step 2 Import whitelist and blacklist to the camera.

- 1) Click **Import** and the window pops up as below.

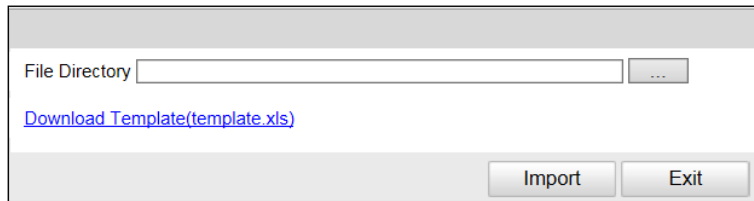

Figure 11-2 Import Whitelist and Blacklist

- 2) Click **Download Template** to download the list template.
- 3) Edit the whitelist and blacklist information according to the template and save it locally.

 **NOTE**

You must edit the whitelist and blacklist information according to the template, or the import will fail.

- 4) Click to select the file directory of the saved list.
- 5) Click **Import** to import the list to the camera.

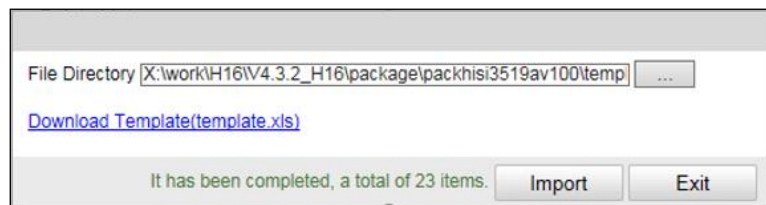

Figure 11-3 Import Completed

 **NOTE**

Up to 10000 items of whitelist and blacklist can be imported once.

- 6) Click **Exit** to return to the Whitelist and Blacklist Configuration page, and you can view the imported vehicle information.

No.	License Plate No.	Belong to	Card No.	Effective Start Time	Effective End Time
1	A12345	Blacklist	abc5555		
2	B12345	Whitelist	abc5554	2014-01-01 01:01:01	2014-02-01 01:01:02

Total 2 Items [First Page](#) [Prev Page](#) 1/1 [Next Page](#) [Last Page](#)

Figure 11-4 Imported Vehicle Information

Step 3 Add whitelist or blacklist vehicle information to the camera.

- 1) Click **Add** and the window pops up as below.

Figure 11-5 Add Whitelist/Blacklist Vehicle Information

- 2) Edit the vehicle information and time.
- 3) Click **OK** to add it and it will be listed on the table.

Step 4 Edit the added whitelist/blacklist vehicle information.

- 1) Select an item from the table and click **Edit**.

Figure 11-6 Edit Whitelist/Blacklist Vehicle Information

- 2) Edit the information.
- 3) Click **OK** to save the settings.

Step 5 Export the whitelist/blacklist list.

- 1) Click **Export**.
- 2) Select the local path to save the list.
- 3) Click **OK** to export the list.

Step 6 Search the whitelist/blacklist vehicle information.

- 1) Configure the search condition and keywords.
 - **License Plate No.:** Enter the complete license plate number in the Keywords text field.

- **Card No.:** Enter the complete card No. in the Keywords text field.
- **Belong to:** Select Whitelist or Blacklist as the keyword.
 - 2) Click **Search** to search the vehicle information and the search result will be listed on the table.

Figure 11-7 Search Vehicle Information

Step 7 Delete the whitelist/blacklist vehicle information.

- 1) Configure the type and keywords.
 - **License Plate No.:** Enter the complete license plate number in the Keywords text field.
 - **Card No.:** Enter the complete card No. in the Keywords text field.

Figure 11-8 Delete Vehicle Information

- 2) Click **Delete** to delete the whitelist/blacklist vehicle information.

11.2 Set Entrance and Exit

Purpose:

You can configure the control mode, relay, vehicle management mode, vehicle information management, and remote barrier gate control for the entrance and exit.

Step 1 Go to **Configuration > Device Configuration > Entrances and Exits > Entrance and Exit.**

Control Mode By Camera ▼

Relay

Relay No.	Relay Function
1	Open ▼
2	Close ▼

Vehicle Information Management

Vehicle Type	Barrier Gate Operation	Alarm Operation
Temporary Vehicle	<input checked="" type="radio"/> No Operation <input type="radio"/> Open Barrier Gate	<input type="checkbox"/> Upload via SDK <input type="checkbox"/> Upload to Alarm Host
Vehicle in Blacklist	<input checked="" type="radio"/> No Operation <input type="radio"/> Open Barrier Gate	<input type="checkbox"/> Upload via SDK <input type="checkbox"/> Upload to Alarm Host
Vehicle in Whitelist	<input checked="" type="radio"/> No Operation <input type="radio"/> Open Barrier Gate	<input type="checkbox"/> Upload via SDK <input type="checkbox"/> Upload to Alarm Host

Remote Control Barrier Gate

Barrier Gate No.	Operation	Barrier Gate Status
1	Close Open Unlock Lock	Check if the rising or falling to position signal of the barrier gate is connected or not.

Save

Figure 11-9 Entrance and Exit Configuration

Step 2 Select **Control Mode**. By Camera is available.

Step 3 Configure **Relay** to control the barrier gate.

You can select **Open**, **Close**, or **N/A** for the relay function. Relay 1 connects 1A and 1B of barrier gate, and Relay 2 connects 2A and 2B of barrier gate.

Step 4 Configure **Vehicle Management Mode**.

Step 5 Configure **Vehicle Information Management**. You can configure the barrier gate operation rules and alarm operations for vehicle of different types.

- 1) Select the **Temporary Vehicle**. **Not Operate** and **Open Gate** are selectable. When you want to choose passing vehicle type, you need to check **Open Gate** after that vehicle type.
- 2) Select the **Alarm Operation**. **Upload via SDK** and **Upload to Alarm Host** are selectable.

- **Upload via SDK**: You can upload the alarm information to platform by SDK.
- **Upload to Alarm Host**: You can upload the alarm information to platform via alarm host.

Step 6 Configure the **Remote Barrier Gate Control**. Click **Close**, **Open**, **Unlock**, or **Lock** to control the barrier gate manually.

Step 7 Click **Save** to save the settings.



Entrance and exit can only apply to License Plate Recognition System Mode.

Chapter 12 Application Mode Configuration

Purpose:

This chapter introduces the parameters configuration under different trigger mode. The supported trigger modes vary according to the camera models.

12.1 Smart Mode

In this mode, target capture and license plate recognition are triggered by internal live video analysis. Smart mode applies to road surveillance.

Step 1 Go to **Configuration > Device Configuration > Application Mode**.

Step 2 Select **Application Mode** as **Smart Mode**.

Step 3 Select **Total Lanes**. Up to 3 lanes are supported.

The screenshot shows the configuration interface for the Smart Mode. At the top, the 'Application Mode' is set to 'Smart Mode'. Below this, the 'Smart Mode Settings' section is visible. It includes a 'Total Lanes' dropdown set to '1', a 'Capture Type' dropdown set to 'Motor Vehicle', and a 'Lane 1' section with 'Lane Direction' set to 'Unknown' and 'Linked Lane No.' set to '1'. To the right of these settings is a live video feed showing a car on a road with lane lines. The video feed also displays the date and time '11-13-2019 Wed 10:53:08' and 'Camera 01'. Below the video feed is a 'Draw Rules Line' button. At the bottom right of the interface are 'Default' and 'Save' buttons.

Figure 12-1 Smart Mode Configuration

Step 4 Select **Capture Type**. **All** and **Motor Vehicle** are selectable.

- **All**: Capture and recognize pedestrian, non-motor vehicle and motor vehicle.
- **Motor Vehicle**: Capture and recognize motor vehicle.

Step 5 Draw rules line.

- 1) Click **Draw Rules line**.

- 2) Adjust the position and length of Lane Line, and Lane Right Border Line according to actual lanes.

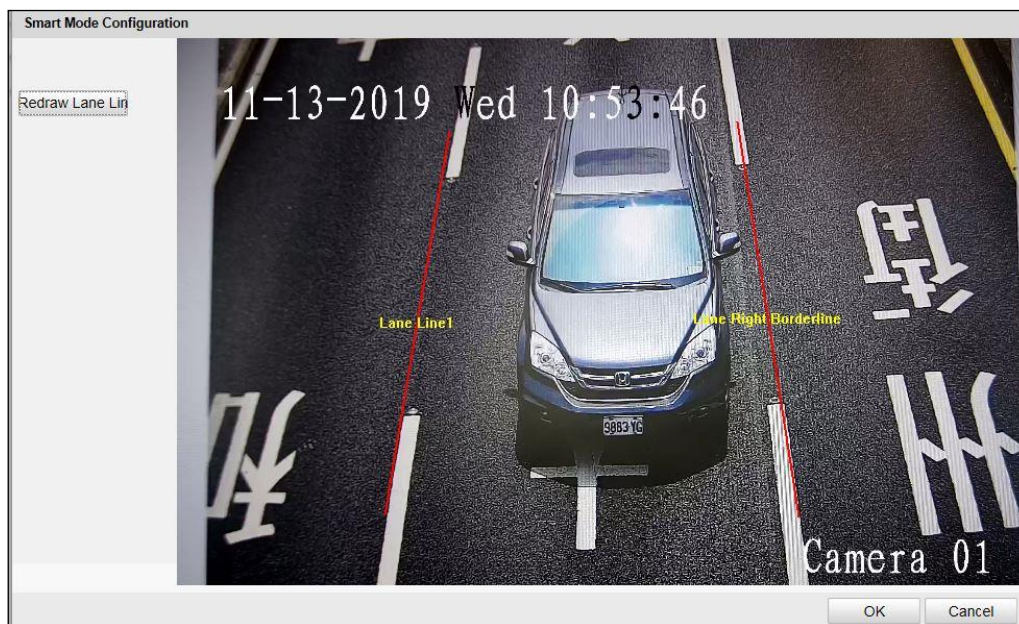

Figure 12-2 Draw LPR Area

- 3) Click **OK** to save the drawing.

Step 6 Set **Lane Direction** and **Linked Lane No.** for lanes.

Step 7 Click **Save**.

12.2 License Plate Recognition System

In this mode, target capture and license plate recognition are triggered by external coil and internal live video analysis. License plate recognition system mode applies to entrance and exit surveillance.

Step 1 Go to **Configuration > Device Configuration > Application Mode**.

Step 2 Select **Application Mode** as **License Plate Recognition System**.

Step 3 Select **Total Lanes**. Only 1 lane is selectable.

Step 4 Select **Trigger Type**. **Video Detection**, **I/O Coil**, and **RS-485** are selectable.

- **Video Detection**

License Plate Recognition System Mode Parameters	
Trigger Type	Video Detection ▼
Picture Mode	Scene Picture ▼
Capture Mode	Strobe Light Mode ▼
Lane 1	
Lane Direction	Unknown ▼
Linked Lane No.	1

Figure 12-3 Video Detection

- 1) Select **Picture Mode**. **Scene Picture** and **Scene Picture + Close-up Picture** are selectable.
- 2) Select **Capture Mode**. **Strobe Light Mode** is selectable.
- 3) Select **Lane Direction**.
- 4) Enter the **Linked Lane No.** ranging from 1 to 99. The lane No. will be overlaid on the captured picture.

● **I/O Coil**

License Plate Recognition System Mode Parameters	
Trigger Type	I/O Coil ▼
Picture Mode	Scene Picture ▼
Lane 1	
Linked Lane No.	1
I/O Trigger Default Status	Falling Edge ▼
Linked I/O No.	IO1 ▼

Figure 12-4 I/O Coil

- 1) Select **Picture Mode**. **Scene Picture** and **Scene Picture + Close-up Picture** are selectable.
- 2) Enter the **Linked Lane No.** ranging from 1 to 99. The lane No. will be overlaid on the captured picture.
- 3) Select **I/O Trigger Default Status**. **Rising Edge** and **Falling Edge** are selectable.
- 4) **Select I/O No.** When the coil detects that there is vehicle passing, a rising or falling edge signal is sent to the linked I/O of the capture unit to trigger capture.

 **NOTE**

The I/O Trigger Default Status and linked I/O No. should be configured according to the actual conditions.

- **RS-485**

License Plate Recognition System Mode Parameters	
Trigger Type	RS-485
Picture Mode	Scene Picture
Lane 1	
Linked Lane No.	1
RS-485 Linked Camera No.	1

Figure 12-5 RS-485

- 1) Select **Picture Mode**. **Scene Picture** and **Scene Picture + Close-up Picture** are selectable.
- 2) Enter the **Linked Lane No.** ranging from 1 to 99. The lane No. will be overlaid on the captured picture.
- 3) Enter **RS-485 Linked Camera No.** ranging from 1 to 16. The No. refers to the RS-485 serial port connected channel No. of the vehicle detector.

Step 5 Draw rules line.

- 1) Click **Draw LPR Area**.
- 2) Check **Lane Line**, **Lane Right limit**, and **Trigger Line**.
- 3) Adjust the position and length of the lines.

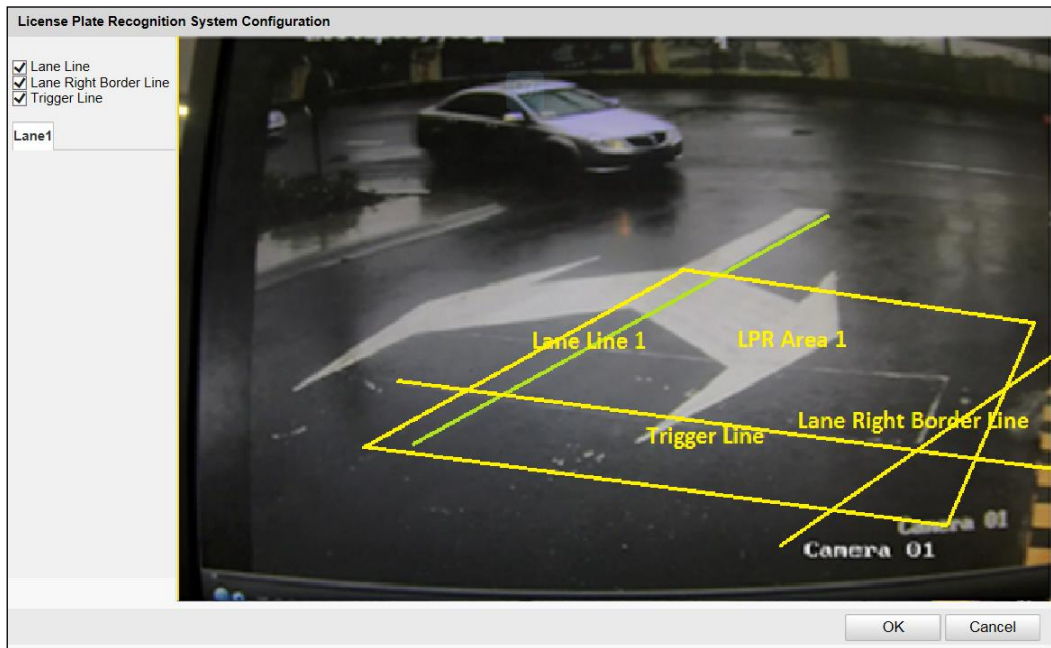

Figure 12-6 Draw Rules Line

4) Click **OK** to save the drawing.

Step 6 (Optional) Click **Get Recommended Value** to get the recommended value of the parameters.

Step 7 Click **Save** to save the settings.

Chapter 13 Exception

Purpose:

The exception type can be HDD error, network disconnected, IP address conflicted, vehicle detector exception, and traffic light detector exception.

Step 1 Go to **Configuration > Device Configuration> Events**.

Step 2 Select the exception type and the corresponding trigger methods.

Enable	Exception Type	Notify Surveillance Center	Trigger Alarm Output	Alarm Duration (s)
<input type="checkbox"/>	HDD Error			
<input type="checkbox"/>	Network Disconnected			
<input type="checkbox"/>	IP Address Conflicted			
<input type="checkbox"/>	Vehicle Detector Exception			
<input type="checkbox"/>	Traffic Light Detector Exception			

Figure 13-1 Exception Settings

- **Notify Surveillance Center:** Send an exception or alarm signal to remote management software when an event occurs.
- **Trigger Alarm Output:** Trigger one or more external alarm outputs when an event occurs.
- **Alarm Duration:** The waiting time for the alarm triggered, and you can set the alarm dwell time from 0 to 180 s.

Step 3 Click **Save** to save the settings.

Chapter 14 Maintenance

14.1 Device Status

Step 1 Go to **Configuration > Device Status**.

Device Status							
Device IP address		10.41.15.200					
Device Status							
Live View Connection	Live View IP Address	Frame Rate	Resolution	Stream Type	Arming Channel	Arming Host Address	Ar
1	10.41.8.167	Full Frame Rate	4096*2160	Main Stream	0		
Check Vehicle Detector Status							

Figure 14-1 Device Status

Step 2 View Device IP Address and Device Status.

- **Device IP Address:** Display the current IP address of the camera.
- **Device Status:** Detailed descriptions are shown in the following table.

Table 14-1 Description of Device Status

Item	Description
Live View Connection	The current number of established live view connection.
Live View IP Address	The IP address of the PC that is viewing the live video.
Arming Channel	The number of channel(s) that armed by arming host(s).
Arming Host Address	The IP address of the host that enables the arming channel.
Arming Level	Arming level 1 and arming level 2 are available. Refer to Section 4.4 for detailed explanation.

14.2 User Management

The admin user should configure the device accounts and user/operator permissions properly, and delete the unnecessary accounts and user/operator permissions.

Go to **Configuration > Device Configuration > User Management**.

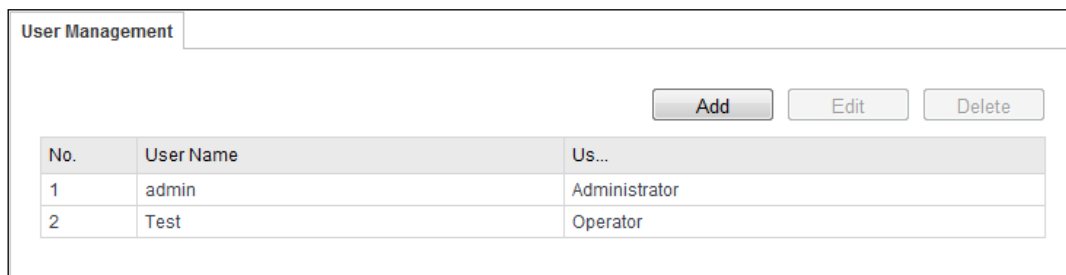

Figure 14-2 User Management

14.2.1 Add a User

The *admin* user has all permissions by default and can create/modify/delete other accounts.

The *admin* user cannot be deleted and you can only change the *admin* password.

Step 1 Click **Add** to add a user.

Step 2 Select **Level**.

Step 3 Enter **User Name** and **Password**.



WARNING

STRONG PASSWORD RECOMMENDED— We highly recommend you create a strong password of your own choosing (using a minimum of 8 characters, including upper case letters, lower case letters, numbers, and special characters) in order to increase the security of your product. And we recommend you reset your password regularly, especially in the high security system, resetting the password monthly or weekly can better protect your product.



NOTE

- Up to 31 user accounts can be created.
- Users of different levels own different permissions. Operator and user are selectable.

Step 4 Confirm the password.

Step 5 Enter **Admin Password**.

Step 6 In the **Basic Permission** field and **Camera Permission** field, you can check or uncheck the permissions for the new user.

Step 7 Click **OK** to add the user.

Add user

User Name

Level

Admin Password

Password

Confirm

Valid password range [8~16]. You can use a combination of numbers, lowercase, uppercase and special character for your password with at least two kinds of them contained.

Basic Permission	Camera Configuration
<input type="checkbox"/> Remote: Parameters Settings	<input checked="" type="checkbox"/> Remote: Live View
<input checked="" type="checkbox"/> Remote: Log Search / Interrogate Working Status	<input type="checkbox"/> Remote: PTZ Control
<input type="checkbox"/> Remote: Upgrade / Format	<input type="checkbox"/> Remote: Manual Record
<input type="checkbox"/> Remote: Two-way Audio	<input checked="" type="checkbox"/> Remote: Search Picture in SD Card
<input type="checkbox"/> Remote: Shutdown / Reboot	
<input type="checkbox"/> Remote: Notify Surveillance Center / Trigger Alarm Output	
<input type="checkbox"/> Remote: Video Output Control	
<input type="checkbox"/> Remote: Serial Port Control	

OK Cancel

Figure 14-3 Add a User

14.2.2 Modify a User

Step 1 Select a user from the list and click **Modify**.

Step 2 Edit the parameters.

Modify user

User Name

Level

Admin Password

Password

Confirm

Valid password range [8~16]. You can use a combination of numbers, lowercase, uppercase and special character for your password with at least two kinds of them contained.

Basic Permission	Camera Configuration
<input checked="" type="checkbox"/> Remote: Parameters Settings	<input checked="" type="checkbox"/> Remote: Live View
<input checked="" type="checkbox"/> Remote: Log Search / Interrogate Working Status	<input type="checkbox"/> Remote: PTZ Control
<input checked="" type="checkbox"/> Remote: Upgrade / Format	<input checked="" type="checkbox"/> Remote: Manual Record
<input checked="" type="checkbox"/> Remote: Two-way Audio	<input checked="" type="checkbox"/> Remote: Search Picture in SD Card
<input checked="" type="checkbox"/> Remote: Shutdown / Reboot	
<input checked="" type="checkbox"/> Remote: Notify Surveillance Center / Trigger Alarm Output	
<input checked="" type="checkbox"/> Remote: Video Output Control	
<input checked="" type="checkbox"/> Remote: Serial Port Control	

OK Cancel

Figure 14-4 Modify Admin

Step 3 Click **OK** to save the settings.

14.2.3 Delete a User

Step 1 Select the user you want to delete and click **Delete**.

Step 2 Click **OK** on the pop-up message box to delete the user.

14.3 Log Search

Purpose:

The operation, alarm, exception and information of the camera can be stored in log files. You can also export the log files on your demand.

Before you start:

Please insert a TF card with up to 128 GB storage in the camera for Log storage. Log cannot be searched if there is no TF card.

Step 1 Click **Log** on the menu bar to enter log searching page.

Time	Major Type	Minor Type	Channel No.	Local/Remote User	Remote Host IP
------	------------	------------	-------------	-------------------	----------------

Figure 14-5 Log Searching

Step 2 Set the log search conditions to specify the search, including **Major Type**, **Minor Type**, **Start Time**, and **End Time**.

Step 3 Click **Search** to search log files. The matched log files will be displayed in the list.

Step 4 To export the log files, click **Save Log** to save the log files in your PC.

14.4 Reboot the Camera

Step 1 Go to **Configuration > Device Configuration > System Maintenance > Reboot**.

Step 2 Click **Reboot** to reboot the camera.



Figure 14-6 Reboot Device

14.5 Restore Default Settings

Step 1 Go to **Configuration > Device Configuration > System Maintenance > Default**.

Step 2 Click **Restore** or **Restore Factory Settings** to restore default settings.

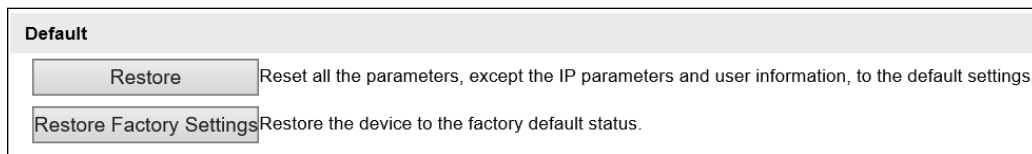

Figure 14-7 Restore Default Settings

14.6 Export Debug File

Step 1 Go to **Configuration > Device Configuration > System Maintenance > Debug File Export**.

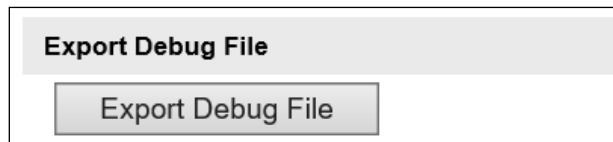

Figure 14-8 Export Debug File

Step 2 Click **Export Debug File** and set the saving path to save the debug file in local storage.

14.7 Export Configuration File

Purpose:

If you have configured a camera and want to use the configured parameters as the example for other cameras, you can export the configuration file to your local PC directory.

Step 1 Go to **Configuration > Device Configuration > System Maintenance > Export Parameters**.

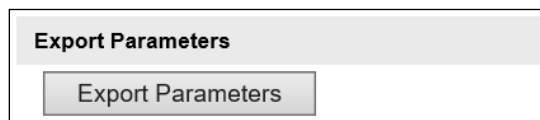

Figure 14-9 Export Parameters

Step 2 Click **Export** and set the saving path to save the configuration file in local storage.

14.8 Import Configuration File

Purpose:

Configuration file is used for the batch configuration of the camera, which can simplify the configuration steps when there are a lot of cameras needing configuration.

Step 1 Go to **Configuration > Device Configuration > System Maintenance > Import Config. File.**

Import Config. File	
Importing Method	Import All
Config. File	<input type="text"/> <input type="button" value="Browse"/> <input type="button" value="Import"/>
Status	

Figure 14-10 Import Config. File

Step 2 Select **Importing Method**. **Import All** and **Partial Import** are selectable.

Step 3 (Optional) For **Partial Import** mode, you should select configuration type(s) to import by checking the corresponding checkbox(s).

Step 4 Click **Browse** to select the saved configuration file.

Step 5 Click **Import** to start importing the configuration file.



NOTE

You need to reboot the camera after importing configuration file.

14.9 Upgrade the System

Step 1 Go to **Configuration > Device Configuration > System Maintenance > Upgrade.**

Upgrade	
Upgrade File	<input type="text"/> <input type="button" value="Browse"/> <input type="button" value="Upgrade"/>
Status	
Note : The upgrading process will take 1-10 minutes. Do not power off.	

Figure 14-11 Remote Upgrade

Step 2 Click **Browse** to select the local upgrade file.

Step 3 Click **Upgrade** to start remote upgrade.

Step 4 (Optional) Click **Configuration > System Configuration > Device Information**, if upgrading succeed, Smart Module Status will display normal.

 **NOTE**

The upgrading process will take 1 to 10 minutes. Do not disconnect power of the camera or reboot the camera during the process, and the camera reboots automatically after upgrade.



See Far, Go Further